

INTRASPIN®



ARCHIVED DOCUMENT

Leukocyte- and Platelet-Rich Fibrin

L02065 Rev C APR 2021

English	Instructions for use: IntraSpin
Español	Instrucciones de uso: IntraSpin
русский	Инструкция по применению: IntraSpin
DEUTSCH	Gebrauchsanweisung: IntraSpin
FRANÇAIS	Instructions d'utilisation: IntraSpin
ITALIANO	Istruzioni per l'uso: IntraSpin
PORTUGUÊS	Instruções de utilização: IntraSpin
Türk	Kullanım talimatları: IntraSpin
简体中文	使用说明 : IntraSpin
日本語	使用説明書 : IntraSpin
한국어	사용 설명서: IntraSpin
عربي	إرشادات الاستخدام: IntraSpin
Polskie	Instrukcja użycia: IntraSpin
čestina	Návod k použití: IntraSpin

BioHorizons

2300 Riverchase Center
Birmingham, AL 35244 USA
+1-205-967-7880

IntraSpin®, Xpression® & L-PRF® are registered trademarks of BioHorizons; Vacuette® is a registered trademark of Greiner Bio-One International AG.; Enzymax® is a registered trademark of Hu-Friedy Mfg. Co., LLC.



The symbol table below is for reference only. Refer to product or product packaging label for applicable symbols.

Symbol	Symbol Description
	Caution
	Electronic instructions for use
	Manufacturer
	BioHorizons products carry the CE mark and fulfill the requirements of the Medical Devices Directive 93/42/EEC
	Reference/ article number
	Lot/ batch number
	Do not re-use
	Do not re-sterilize
	Use-by-date
	Sterile by gamma irradiation
	Date of manufacture
	Caution: U.S. Federal law restricts these devices for sale, distribution and use by, or on the order of, a dentist or physician

Symbol	Symbol Description
	Home position
	Do not use if package is damaged
	Medical Device
	Non-sterile
	Keep dry
	Fragile; handle with care
	Temperature limits
	This way up
	Humidity limits
	Warning; Biological hazard
	Important note(s)
	Separate collection of electric and electronic devices.
	Authorized representative in the European Community

1 INDICATIONS FOR USE

The IntraSpin System is intended to be used for the safe and rapid preparation of autologous Leukocyte- and Platelet-Rich Fibrin (L-PRF) from a small sample of blood at the patient's point of care. The L-PRF is mixed with autograft and/or allograft bone prior to application to a bony defect for improving handling characteristics. Observing all information in the Instructions for Use is also a part of the intended use.

2 CONTRAINDICATIONS

The IntraSpin centrifuge is only meant for the purpose stated in the intended use of the device. Any other use of the device is considered non-intended. Use of the IntraSpin centrifuge is contraindicated in the presence of one or more of the following clinical situations: Patients with alcohol addiction or psychiatric disorders, blood dyscrasias, uncontrolled diabetes, hyperthyroidism, oral infections, malignancies or patients who have had myocardial infarction within the last 12 months. Patients with systemic diseases that compromise the immune system, such as AIDS, patients on medications that would compromise healing of an implant site, patients with a history of poor or noncompliance to oral hygiene procedures.

Patients who are participating in anti-coagulant therapy. These patients are not excluded from the benefits of PRF, instead the point of care must add additional time to the centrifuge for the separation to be effective for use.



3 SAFETY NOTES

- No claim of warranty will be considered by the manufacturer unless ALL instructions in this manual have been followed.
- The operating instructions are a part of the device. They must always be kept readily available. If the device is set up at a different location, the operating instructions must be provided with it.
- The centrifuge should be installed on a good, stable base.
- Before using the centrifuge absolutely check the rotor for firm placement.
- When the centrifuge is running, no persons, dangerous substances or objects may be within the safety margin of 300 mm around the centrifuge.
- Rotors, suspensions and accessories that possess traces of corrosion or mechanical damage or if their term of use has expired may not be used any longer.
- The centrifuge may no longer be put into operation when the centrifuging chamber has safety-related damages.
- For centrifuges without temperature control, when the room temperature is increased and/or if the device is frequently used, the centrifuging chamber could be heated up. Therefore, it can't be ruled out that the sample material might be changed due to the temperature.
- Before the initial operation of your centrifuge you should read and pay attention to the operating instructions. Only personnel that has read and understood the operating instructions are allowed to operate the device.
- Along with the operating instructions and the legal regulations on accident prevention, you should also follow the recognized professional regulations for working in a safe and professional manner. These operating instructions should be read in conjunction with any other instructions concerning accident prevention and environmental protection based on the national regulations of the country where the device is to be used.

- Meeting the country-specific requirements concerning occupational safety with regard to the use of centrifuges at the workplaces provided for this purpose by the user is the responsibility of the user.
- This centrifuge is a state-of-the-art piece of equipment which is extremely safe to operate. However, it can lead to danger for users or others if used by untrained staff, in an inappropriate way or for a purpose other than that it was designed for.
- The centrifuge must not be moved or knocked during operation.
- In case of fault or emergency release, never touch the rotor before it has stopped turning.
- To avoid damage due to condensate, when changing from a cold to a warm room the centrifuge must either heat up for at least 3 hours in the warm room before being connected to the mains or run hot for 30 minutes in the cold room.
- When centrifuging with maximum revolutions per minute the density of the materials or the material mixtures may not exceed 1.2 kg/dm³.
- The centrifuge may only be operated when the balance is within the bounds of acceptability.
- The centrifuge may not be operated in explosion-endangered areas.
- The centrifuge must not be used with inflammable or explosive materials or materials that react with one another producing a lot of energy.
- No biosafety systems are available for this centrifuge.
- The centrifuge must not be operated with highly corrosive substances which could impair the mechanical integrity of rotors, hangers and accessories.
- Repairs must only be carried out by personnel authorized to do so by the manufacturer.
- In order to offer patients the highest level of clinical safety, IntraSpin products are made with materials that are biocompatible with human plasma.
- This product is not authorized for sale in every market and it may not be available in your market. Please consult with your local representative for additional information.

4 INTRASPIN SYSTEM COMPONENTS

COMPONENT	QUANTITY PER SYSTEM
IntraSpin Centrifuge including:	1
Power Cable	1
Fuse	2
Hex Hand Wrench	1
Greiner Blood collection tubes and balancing tubes (single use)	150
Greiner Safety Blood Collection Set + Holder, 21G (single use)	24
Latex Free Tourniquet	1
Test Tube Rack	1
Surgical Curved Scissors	1
Surgical Tissue Forceps	1
Round Stainless-Steel Bowl	1
Rectangular Stainless-Steel Bowl	1
Dual Biomaterial Carrier Spatula	1
Dual Biomaterial Packer	1
Xpression® Box	1

Only verified compatible components for direct use with the IntraSpin centrifuge are recommended and warranted:

COMPATIBLE PART #	DESCRIPTION
455092	Red Cap 9ml CAT Serum Clot activator tubes
455001	White Cap 9ml Z No additive tubes
BHEXZ (E613)	IntraSpin Hex Key, 110v & 220v
BROTORZ (E3694)	IntraSpin Rotor, 100v & 220v
BPOWER110Z (E1673)	IntraSpin Power Cord, 110v
BPOWER220Z (E1669)	IntraSpin Power Cord, 220v
BTUBEHOLDZ (E872 x 1)	IntraSpin Tube Holder Replacement
BFUSE110Z (E997)	IntraSpin Fuse 110v
BFUSE220Z (E891)	IntraSpin Fuse 220v

5 BRIEF CENTRIFUGE SETUP

Remove and save transport bolts from bottom of centrifuge.

Attach AC cable and plug into electrical outlet.

Power centrifuge on by using the rocker switch on the back of the device.

Select speed and time: Speed = 2700 & Time = 12:00 min.

Press START.

The centrifuge cover will open automatically at the end of each cycle.

After the first procedure, the timing and speed are recorded in the centrifuge memory unless the settings are changed.

6 BLOOD COLLECTION TUBES AND BLOOD COLLECTION SET CAUTIONS AND INSTRUCTIONS

- Do not use tubes if foreign matter is present.
- Blood collection tubes must be allowed to fill completely.
- Handle all biological samples and blood collection “sharps” (e.g. needles, and blood collection sets) according to the policies and procedures of your facility.
- Do not bend the needle.
- Do not forcefully release or re-activate the needle safety mechanism after it has been activated.
- Obtain appropriate medical attention in the case of any exposure to biological samples (e.g. via puncture injury) due to the possible transmission of HIV (AIDS), viral hepatitis or other infectious diseases.
- Discard all blood collection “sharps” in approved biohazard containers.
- Transferring a sample from a syringe to a tube is not a recommended procedure.
- If blood is collected through an intravenous (IV) line, follow the policies and procedures of your institution to ensure that the line has been cleared of IV solution before beginning to fill the blood collection tubes.
- Blood clotting accelerant may appear white on the tube surface, which has no effect on the performance of the tubes. If any other discoloration or precipitates are present in the tube, it should not be used.
- Do not use the tubes after the expiration date.
- Store blood collection tubes at 4–25°C (40–77°F).
- Store blood collection set (needle and holder) at 4–36°C (40–97°F).

- Avoid exposure to direct sunlight. Exceeding the maximum recommended storage temperature may lead to impairment of the tube quality (i.e. vacuum loss, coloring, etc.).
- To prevent backflow, place the patient's arm in a downward position, hold the tube with the cap up, release the tourniquet as soon as blood starts to flow into the tube, avoid tube contents coming in contact with cap or end of the needle during venipuncture.
- Be sure that the following materials are readily accessible before performing venipuncture: all necessary blood collection tubes, identified labels for positive patient identification of samples, blood collection needles and holders, alcohol swab for cleansing the puncture site, clean gauze, tourniquet, adhesive plaster or bandage, approved biohazard container. For protection against exposure to bloodborne pathogens, appropriate PPE (Personal Protective Equipment) is recommended (e.g. gloves, laboratory coat, goggles, etc.).

Venipuncture Technique and Blood Sample Collection:

The blood collection must be made as quickly as possible, since there is no anticoagulant in the collection tubes. The blood sample will begin to coagulate immediately. Wear gloves during venipuncture and when handling blood collection tubes to minimize exposure hazard. Prior to the blood draw, wipe the top of the blood tube cap(s) with a disinfectant wipes of your choice. Remove the cover over the valve section of the needle. Prepare venipuncture site with an appropriate antiseptic. Do not palpate venipuncture area after cleansing. Place the patient's arm in a downward position. Remove the needle cap. Perform the venipuncture with the arm downward and tube cap upper-most. Immobilize the needle with tape when necessary. Push the blood collection tube into the holder and onto the needle valve puncturing the rubber diaphragm of the blood collection tube. Center the blood collection tubes in the holder when penetrating the cap to prevent sidewall penetration and subsequent premature vacuum loss. Remove the tourniquet as soon as blood appears in the blood collection tube. During procedure, always hold the collection tube in place by pressing it with a thumb. This will ensure a complete vacuum draw. The blood collection tube will fill automatically. If no blood flows into collection tube or if blood flow ceases before an adequate specimen is collected, the following steps are suggested to complete a satisfactory collection:

- Push the blood collection tube forward to ensure the cap has been penetrated.
- Confirm the correct position of the needle in the vein.
- If blood still does not flow, remove and appropriately discard the collection tube. Obtain a new collection tube and push into holder.
- If the second collection tube does not draw, remove and appropriately discard the needle and the collection tube. Repeat the procedure.
- When the maximum volume fill line of the blood collection tube has been reached, gently remove it from the holder. Repeat with a second blood collection tube.

Gently invert each collection tube immediately upon removing from the holder. Do not shake the tubes filled with blood sample. Vigorous mixing may cause foaming or hemolysis. Insufficient mixing or delayed mixing in serum tubes may result in delayed clotting. Upon completion of blood sample collection, remove the needle from the vein. Activate the safety mechanism (safety shield) of the needle by pressing in both sides of the hub to engage the lock. Slide the safety mechanism backward until an audible click is heard. Do not recap the needle as this increases the risk of needle stick injury and blood exposure. Dispose of the used needle with holder using a suitable biohazard disposal container. Apply pressure to the puncture site with a dry

sterile swab until the bleeding stops. If desired, apply a bandage once clotting has occurred. It is recommended that filled collection tubes, be kept in an upright position. Once the second blood collection tube is full, remove it and place the first and second tubes into the centrifuge on opposite locations to counterbalance the rotor. Close the cover of the IntraSpin centrifuge and press the START button to allow it to spin for 12 minutes.

If more than two tubes of blood are required, please follow this alternative procedure: After the first two tubes of blood are collected and gently inverted, immediately place them into the IntraSpin centrifuge, opposite from each other to ensure the centrifuge is properly balanced. Close the cover and press the START button and allow the centrifuge to run while you collect the remaining tubes of blood. Press the STOP button and allow the centrifuge to come to a full stop. The cover will pop open; immediately place the remaining tubes in the centrifuge opposite from each other to ensure proper balance and press the START button to reset and complete recommended protocol.

Always place the tubes in pairs and place them in opposite positions to balance the centrifuge rotor. The tubes must always be balanced in the rotor before pressing the START button or this may cause serious damage to the centrifuge, improper coagulation, and/or separation. If the tubes are not properly balanced, there will be too much vibration during centrifugation and a poor L-PRF fibrin clot will result.

If you have an odd number of blood samples to centrifuge, then place a white cap balancing tube (e.g., 455001), filled with water to the indicated full line, opposite to the un-paired tube in the rotor. This will allow for proper balancing of the centrifuge.

Begin centrifugation immediately after collecting the blood samples. Delays affect the blood separation procedure and result in a poor L-PRF fibrin clot.

7 L-PRF PREPARATION

After centrifugation, three segments are visible:

1. Upper Segment = platelet poor plasma (PPP).
2. Middle Segment = fibrin clot: L-PRF.
3. Lower Segment = red blood cell clot.

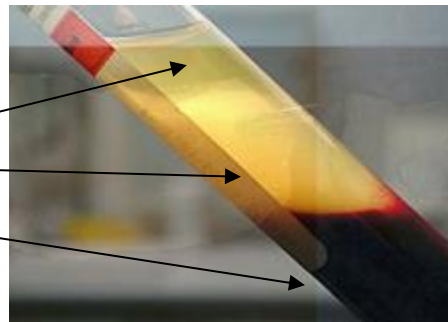

L-PRF fibrin membranes or plugs must be prepared relatively quickly: 0-15 minutes after centrifugation or the clot will shrink in volume by releasing the trapped serum. After centrifugation, remove the rubber stopper from each tube. Using the Surgical Tissue Forceps remove the L-PRF clot from the tube. Gently scrape the red blood cell clot from the L-PRF® fibrin clot just below the union, using the Dual Biomaterial Carrier Spatula, so that only a minimal, residual amount of red blood cells are attached to L-PRF clot. Place the fibrin clot onto the Xpression Perforated Tray.

8 FIBRIN MATRIX PREPARATION

Protocol #1 L-PRF Membrane

Place each of the fibrin clots on the Xpression Perforated Tray. Once all of the fibrin clots are placed, place the Xpression Compression Plate and Xpression Weighted Cover over the fibrin clots without exerting any pressure over the clots.

Allow the weight of the cover to slowly press down the fibrin clot while the exudate is filtered to the bottom of the tray. Do not apply pressure to the weighted cover. Gravitational force on the weighted cover will gently compress the clot and express the serum from the L-PRF clot without damaging the fibrin network.

Wait at least 5 minutes before removing and using any fibrin membranes. Do not remove any fibrin membranes until actual time of use. The fibrin membrane may remain in the Xpression Box for a period of up to 3 hours.

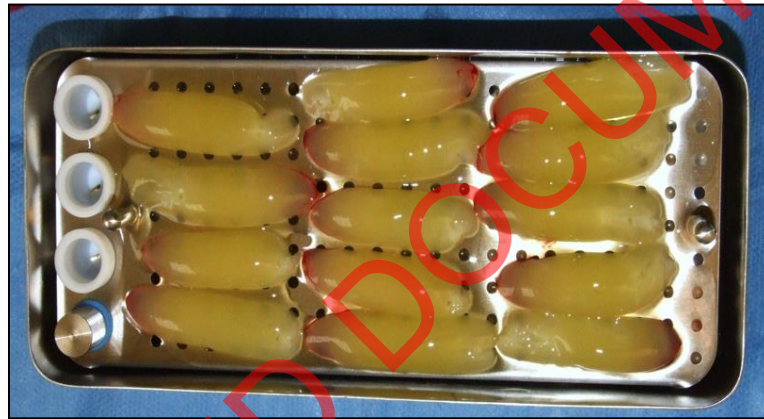

Protocol #2 L-PRF Plug

Place a fibrin clot inside the white plug fabrication cylinder. Use the piston to slowly press the clot inside the white L-PRF plug fabrication cylinder. Continue to press until the top edge of the piston is flush with the top edge of the white L-PRF plug fabrication cylinder. With this technique, one will be able to form a thick, round fibrin plug for the extraction socket. For a single tooth, one L-PRF plug may be sufficient. Pre-molars may need two L-PRF plugs, and three L-PRF plugs may be needed for molars, depending on the size of the extraction socket and the size of the fibrin clot created.

The working properties of L-PRF provide an excellent medium for use in combination with your biomaterial of preference. Utilizing any of the following mixing protocols, the biomaterial is captured in the fibrin matrix increasing its handling and biologic capacity.

Protocol #3- Biomaterial/L-PRF Mixture

To create a 'putty like' mixture that can be gently formed with the biomaterial instrument into the desired shape and thickness use the following protocol: Gently cut the L-PRF fibrin membrane into small pieces in a sterile dish with the Surgical Curved Scissors. Add the desired amount of bone graft material.

Thoroughly mix the L-PRF and bone graft material. This mixture can be placed into defects using the Dual Biomaterial Carrier Spatula.



Protocol #4- Biomaterial/L-PRF Matrix Mixture

Place the predetermined amount of bone graft material into a sterile bowl or tray. Dip the expressed L-PRF membrane(s) or pieces of the L-PRF membrane into the graft material covering the entire surface area of the L-PRF membrane with graft material. Alternatively, the graft material may be sprinkled onto the L-PRF membrane covering the entire surface area with graft material. Note: A wetter L-PRF membrane may retain slightly more graft material than a dryer L-PRF membrane. The graft material should cling to the surface of the L-PRF, however, if desired, gently press the graft material onto the L-PRF membrane. The Surgical Tissue Forceps can be used to place this mixture into the defect.



Protocol #5- Biomaterial Hydration

Add the desired amount of bone graft material into a sterile bowl or tray. Utilize the exudate from the bottom of the Xpression Collection Tray to hydrate the graft material. Thoroughly mix the exudate and bone graft material. This mixture can be placed into defects using the Dual Biomaterial Carrier Spatula.

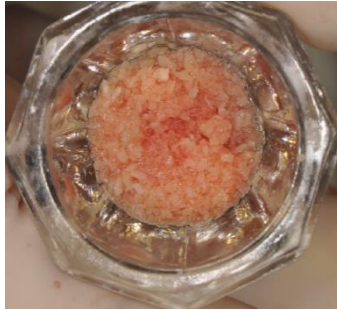

9 TISSUE REGENERATION KIT CLEANING AND STERILIZATION

The Xpression Box enables the fabrication of fibrin membranes of constant thickness with ease. The exudate can be collected from the Xpression Collection Tray, underneath the Xpression Perforated Tray. The Xpression Box includes L-PRF plug fabrication cylinders and a piston to fabricate L-PRF plugs that easily fit post-extraction sockets.



Xpression Weighted Cover



Xpression Compression Plate



Xpression Perforated Tray in
Xpression Collection Tray

The Xpression Box and ancillary instruments are NOT supplied sterile. Remove and discard any shipping material before initial sterilization. Clean and sterilize the Xpression Box and ancillary instruments before each use.

Disassemble the Xpression Box before each cleaning and sterilization cycle to avoid debris encapsulation, material discoloration, and/or inadequate drying of components. The L-PRF plug fabrication cylinders and piston grommet are not intended to be removed from the Xpression Perforated Tray for cleaning and sterilization.

Cleaning: (1) Remove any visible debris from the Xpression Box components and ancillary instruments using a soft bristle brush and a broad-spectrum cleaning or disinfecting agent such as Hu-Friedy's Enzymax® or equivalent. Rinse thoroughly. (2) Place the Xpression Box components and ancillary instruments in an appropriately sized container of the same solution and sonicate for 10 minutes. Rinse thoroughly. (3) Rinse the Xpression Box components and ancillary instruments with isopropyl alcohol to remove any soap residue and minerals. (4) Blot the Xpression Box components and ancillary instruments with a lint-free towel and air dry completely. Refer to the labeling of the cleaning agent used for instructions for use.

Sterilization: (1) Place the reassembled Xpression Box and ancillary instruments in an FDA cleared sterilization bag or wrap. (2) Run through one of the following qualified sterilization cycles:

Sterilization Method	Temperature	Exposure Time	Minimum Drying Time
Pre-vacuum Steam (ANSI/AAMI ST79)	132°C (270°F)	4min	20-30 minutes
Pre-vacuum Steam (UK DoH Health Technical Memorandum 01-01)	134°C (273°F)	3min	20-30 minutes

Attention! Improper cleaning may lead to inadequate sterilization. Failure to completely dry the Xpression Box components and ancillary instruments during autoclaving may leave moisture and cause discoloration and oxidation. The use of hydrogen peroxide or other oxidizing agents will damage the surface of the Xpression Box components and ancillary instruments. Periodic testing, cleaning, and calibration of the autoclave equipment is recommended to ensure the unit remains in proper working order.

10 CENTRIFUGE CLEANING AND MAINTENANCE

The device can be contaminated. Pull the mains plug before cleaning. Centrifuges, rotors and accessories must not be cleaned in rinsing machines. They may only be cleaned by hand and disinfected with liquids. The water temperature must be between 20 – 25°C. Only detergents/disinfectants with a pH between 5 - 8 and that do not contain caustic alkalis, peroxides, chlorine compounds, acids and alkaline solutions may be used. In order to prevent appearances of corrosion through cleaning agents or disinfectants, the application guide from the manufacturer of the cleaning agent or disinfectant must be considered.

Clean the centrifuge housing and the centrifuging chamber regularly, using soap or a mild detergent and a damp cloth if required to prevent corrosion through adhering impurities. Ingredients of suitable detergents include soap, anionic surfactants and non-ionic surfactants. After using detergents, remove detergent residue by wiping with a damp cloth. The surfaces must be dried immediately after cleaning. In the event of water condensation, dry the centrifugal chamber by wiping out with an absorbent cloth. Lightly rub the rubber seal of the centrifuge chamber with talcum powder or a rubber care product after each cleaning. The centrifuging chamber is to be checked for damage. If damage is found to be relevant to safety, the centrifuge may no longer be put into operation. In this case, notify Customer Service.

For surface disinfection, if infectious materials penetrate into the centrifugal chamber, it must be disinfected immediately. Ingredients of suitable disinfectants include ethanol, n-propanol, ethyl hexanol, anionic surfactants and corrosion inhibitors. After using disinfectants, remove disinfectant residue by wiping with a damp cloth. The surfaces must be dried immediately after disinfecting.

For removal of radioactive contaminants, the agent must be specifically labelled as being an agent for removing radioactive contaminants. Ingredients of suitable agents for removing radioactive contaminants include anionic surfactants, non-ionic surfactants, polyhydrated ethanol. After removing the radioactive contaminants, remove the agent residue by wiping with a damp cloth. The surfaces must be dried directly after removing the radioactive contaminants.

11 ROTOR AND ACCESSORIES CLEANING AND MAINTENANCE

To avoid corrosion and changes to the materials, the rotor and accessories have to be cleaned regularly with soap or a mild cleaning agent and a moist cloth. Cleaning is recommended at least once a week. Contaminants must be removed immediately.

Ingredients of suitable detergents include soap, anionic surfactants and non-ionic surfactants. After using detergents, remove detergent residue by rinsing with water (only outside of the centrifuge) or wipe off with a damp cloth. The rotor and accessories have to be dried immediately after cleaning. Check the rotor and accessories weekly for wear and corrosion damage. The rotor and accessories must no longer be used if they show signs of wear or corrosion. Check the firm seating of the rotor on a weekly basis. If infectious material should get on the rotor or accessories, they must be appropriately disinfected.

Ingredients of suitable disinfectants include ethanol, n-propanol, ethyl hexanol, anionic surfactants and corrosion inhibitors. After using disinfectants, remove disinfectant residue by rinsing with water (only outside of the centrifuge) or wipe off with a damp cloth. The rotor and accessories must be dried directly after disinfection.

For removal of radioactive contaminants, the agent must be specifically labelled as being an agent for the removal of radioactive contaminants. Ingredients of suitable agents for removing radioactive contaminants include anionic surfactants, non-ionic surfactants and polyhydrated ethanol. After removing the radioactive contaminants, remove agent residue by rinsing with water (only outside of the centrifuge) or wipe off with a damp cloth. The rotor and accessories must be dried directly after removing the radioactive contaminants.

The rotor may be autoclaved at 121°C/250°F for 20 minutes and dried appropriately. After 10 autoclaving cycles, the rotor must be exchanged for safety reasons. Autoclaving accelerates the ageing process of plastics and may cause discoloration. After autoclaving, wait until the rotor has cooled down to the ambient temperature before using it again. No statement can be made about the degree of sterility.

The period of use of the rotor is limited to 50,000 running cycles (centrifugation runs) or 5 years, whichever comes first. The maximum permissible number of run cycles can be seen on the rotor. For safety reasons, the rotor may no longer be used when the maximum allowed number of running cycles (marked on it) has been reached. The device is equipped with a cycle counter which counts the running cycles (centrifugation runs).

In case of blood tube fracture, all broken parts and blood are to be completely removed. The centrifuge is to be thoroughly cleaned as indicated and rubber inserts as well as plastic sleeves of the rotor are to be replaced.

12 CENTRIFUGE TECHNICAL SPECIFICATIONS

Model Type	IS220Z	IS110Z
Mains voltage ($\pm 10\%$)	200 - 240 V 1~	100 - 127 V 1~
Mains frequency	50 - 60 Hz-	50 - 60 Hz
Connected load	100 VA	100 VA
Current consumption	0.5 A	1.0 A
Capacity	8 x 10 ml	
Maximum allowed density	1.2 kg/dm ³	
Maximum Speed (RPM)	6,000	
Force (RCF)	3,461	
Kinetic energy	750 Nm	
Set-up site	Indoors only	
Altitude	Up to 2000 m above sea level	
Ambient temperature for operation	5°C to 40°C	
Relative Humidity for operation	Maximum relative humidity 80% for temperatures up to 31°C, linearly decreasing to 50% relative humidity at 40°C.	
Excess-voltage category	II	
Pollution degree	2	
Device protection class	I	
	Not suitable for use in explosion-endangered areas.	
Emitted interference, Interference immunity	EN / IEC 61326-1, Class B	FCC Class B
Noise level (dependent on rotor)	≤ 50 dB(A)	
Centrifuge width	261 mm	
Centrifuge Depth	353 mm	
Centrifuge Height	228 mm	
Centrifuge Weight	approx. 9 kg	

13 CENTRIFUGE OPERATING INSTRUCTIONS

It is imperative that the transport securing device, consisting of 2 screws (a) and 2 spacers (b), be removed. Keep the transport securing device in a safe place since it must be installed again before transporting the device. The device may only be transported with the transport securing device installed. To protect the device from damage during transport, the motor is fixed in place. This transport securing device must be removed when the device is put into operation.

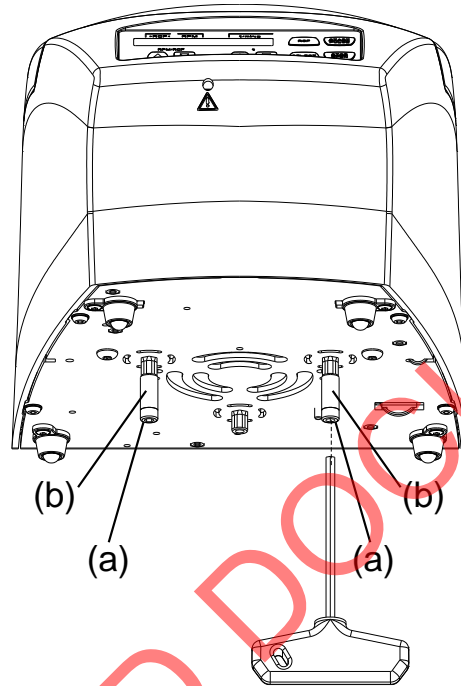

13.1 INITIAL OPERATION

- Remove the transport securing device from the centrifuge bottom side.
- Position the centrifuge in a stable and level manner in a suitable place. When the centrifuge is running, no persons, dangerous substances or objects may be within the safety margin of 300 mm around the centrifuge.
- Ventilation openings must not be blocked. A distance of 300 mm must be maintained from the ventilation slots and openings of the centrifuge.
- Check whether the mains voltage tallies with the statement on the type plate.
- Connect the centrifuge with the power cord to a standard mains socket.
- Switch on the mains switch.
- The following displays appear on the panel: the centrifuge model type, the software version, and the last used centrifugation data.
- If the lid is closed, the message "Open the lid" is displayed. In this case, open the lid to display the centrifugation data.



13.2 OPENING AND CLOSING THE CENTRIFUGE LID

The lid can only be opened if the centrifuge is switched on and the rotor is stationary. When the cycle counter is activated, after a centrifugation run, while opening the lid, the remaining number of running cycles (centrifugation runs) is briefly displayed.



Example:



To open the lid, Press the following key . The lid is unlocked by the motor.  indicates lid unlocked.



Example:

Do not reach with your fingers between the lid and housing. Do not slam the lid closed.

To close the lid, lightly press down the front edge of the lid.  indicates lid locked.



Example:

13.3 EMERGENCY UNLOCKING

In the event of a power failure, the lid cannot be unlocked with the motor. Emergency unlocking must be done by hand. To unlock in an emergency, switch off the mains switch (switch setting "0"). Look through the window in the lid to make sure that the rotor is at a standstill. Open the lid only when the rotor is at a standstill. Insert the Allen key horizontally in the bore (A) and turn carefully counterclockwise (to the left) until the lid opens. CAUTION! Turning the hexagon Allen key in clockwise direction (to the right) may damage the locking system. Pull the Allen key back out of the bore.

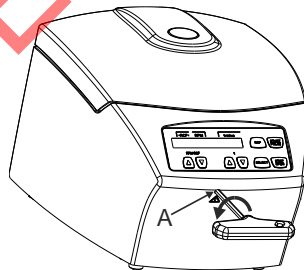

13.4 INSTALLATION AND REMOVAL OF THE ROTOR

To remove the rotor, loosen the rotor's clamping nut by turning counter-clockwise with the Allen wrench (included in delivery) and turn up to the lifting pressure point. After overcoming the lifting pressure point, the rotor is released from the cone of the motor shaft. Turn the clamping nut until the rotor can be lifted up from the motor shaft. Lift up the rotor from the motor shaft.

To install the rotor, clean the motor shaft (A) and the bore of the rotor and apply a thin coat of grease to the motor shaft. Dirt particles between the motor shaft and rotor prevent the rotor from having a perfect seat and cause it to run unsteadily. Place the rotor vertically onto the motor shaft. When putting on the rotor, the marking beam (B) on the rotor must be parallel to both surfaces (C) on the motor shaft. Tighten the clamping nut of the rotor with the Allen wrench (included in delivery) by turning clockwise. Check the rotor to make sure it is seated firmly.

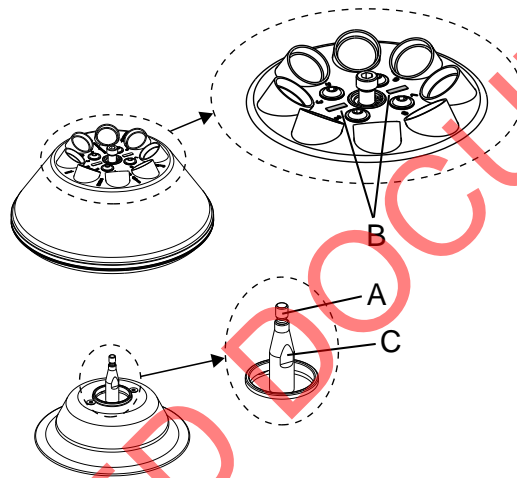

The rotors must be loaded symmetrically. The blood tubes have to be distributed evenly on all rotor positions.

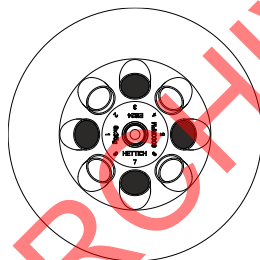

Rotor evenly loaded

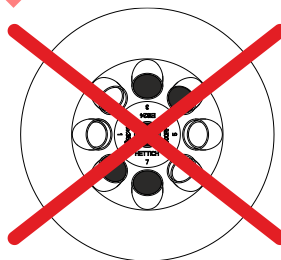

Rotor not evenly loaded
Not permitted!

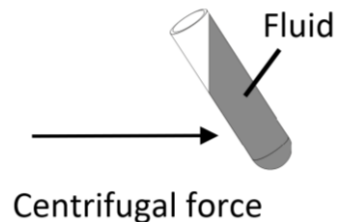

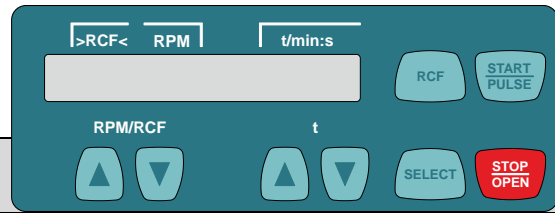

The blood tubes may only be filled outside of the centrifuge. The maximum filling quantity for the blood tubes is specified on the tubes themselves and must not exceed the maximum weight listed on the rotor. The centrifuging vessels may only be filled so far that no fluid can be expelled from them while the centrifuge is running. When loading the rotor, no liquid may enter the rotor or the centrifuging chamber. In order to maintain the weight differences within the centrifuge container as marginal as possible, a consistent fill level in the blood tubes is recommended.

13.5 DISPLAY ELEMENTS DESCRIPTION



Symbol / Panel Key	Description
	Lid unlocked.
	Lid locked.
	Rotation display. The rotation display lights up, rotating in a clockwise direction, when the rotor is turning.
	To input speed directly. If the key is kept pressed, the value changes with increasing speed.
	To input the runtime directly. Adjustable in steps of 1 second up to a minute, and in steps of 1 minute starting from 1 minute. To input the centrifugation parameters. If the key is kept pressed, the value changes with increasing speed.
	To activate individual parameters. Every time the key is pressed, the next parameter is activated. Keep the key pressed for 8 seconds to call up the "MACHINE MENU". In the "Machine Menu", select the menus "->Info", "->Settings" and "Time & Cycles". To scroll forward in the menus.
	To switch between the speed display (RPM) and relative centrifugal force display (RCF). RCF values are displayed between arrows ><.
	To start the centrifugation run. For short-term centrifugation. Centrifugation is run as long as the key is kept pressed. To select the menus "->Info", "->Settings" and "->Time & Cycles".
	To finish the centrifugation run. The rotor runs down with a pre-selected brake stage. Pressing the key twice triggers the Emergency Stop. To unlock the lid.
t/min	Runtime. Adjustable from 1 - 99 minutes, in steps of 1 minute.
t/sec	Runtime. Adjustable from 1 - 59 seconds, in steps of 1 second. Continuous run "--:--". Set the parameters t/min and t/sec to zero.
RPM	Speed. A number value from 200 RPM to the maximum speed of the rotor can be set. Adjustable in steps of 10.
>RCF<	Relative centrifugal force. A number value can be set which results in a speed between 200 RPM and the maximum rotor speed. Adjustable in steps of 1. It is only possible to input the relative centrifugal force (RCF) if the RCF display (>RCF<) is activated. The relative centrifugal force (RCF) depends on the centrifuging radius (RAD). After entering the RCF, check to make sure that the correct centrifuging radius has been set.
RAD/mm	Centrifuging radius. Adjustable from 10 mm to 250 mm, in steps of 1 mm. It is only possible to input the centrifuging radius if the RCF display >RCF< is activated.
	Brake stage. fast = short run-out time, slow = long run-out time.



13.6 DIRECT INPUT OF THE CENTRIFUGATION PARAMETERS

The speed (RPM), the relative centrifugal force (RCF), the centrifuging radius (RAD) and the runtime can be inputted directly with the keys   without previously having to press the  key. The set centrifugation parameters are only stored after starting the centrifugation run.



For Speed (RPM):

 Press the key to activate the RPM display (RPM) as needed.

RPM/RCF Set the desired value with the keys.



Example:



For Relative Centrifugal Force (RCF) and Centrifugal Radius (RAD):

 Press the key to activate the RCF display (>RCF<) as needed.





RPM/RCF Set the desired RCF value with the keys.

t Set the desired centrifuging radius with the keys as needed.

Example:



Runtime:

Up to 1 minute, the runtime can be set in steps of 1 second, and starting from 1 minute, it can only be set in steps of 1 minute. In order to set the continuous run, the parameters **t/min** and **t/sec** must be set to zero. In the time display (t/min:s), "--:--" appears.

Example:



t Set the desired value with the keys.

Example:

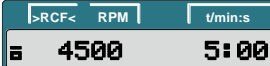

13.7 INPUT OF THE CENTRIFUGATION PARAMETERS WITH THE "SELECT" KEY

The runtime can be set in minutes and seconds (parameters **t/min** and **t/sec**). In order to set the continuous run, the parameters **t/min** and **t/sec** must be set to zero. In the time display (t/min:s), "--:--" appears.



The relative centrifugal force (RCF) depends on the centrifuging radius (RAD). During the input of the RCF, the set centrifuging radius is displayed. If no key is pressed for 8 seconds after selection or during parameter input, the previous values are shown on the display. The parameters must then be entered again. By pressing the button, the settings will be saved. If several parameters are entered, the key must be pressed after setting the last parameter. Entering parameters can be cancelled at any time by pressing the key. In this case, the settings are not stored.

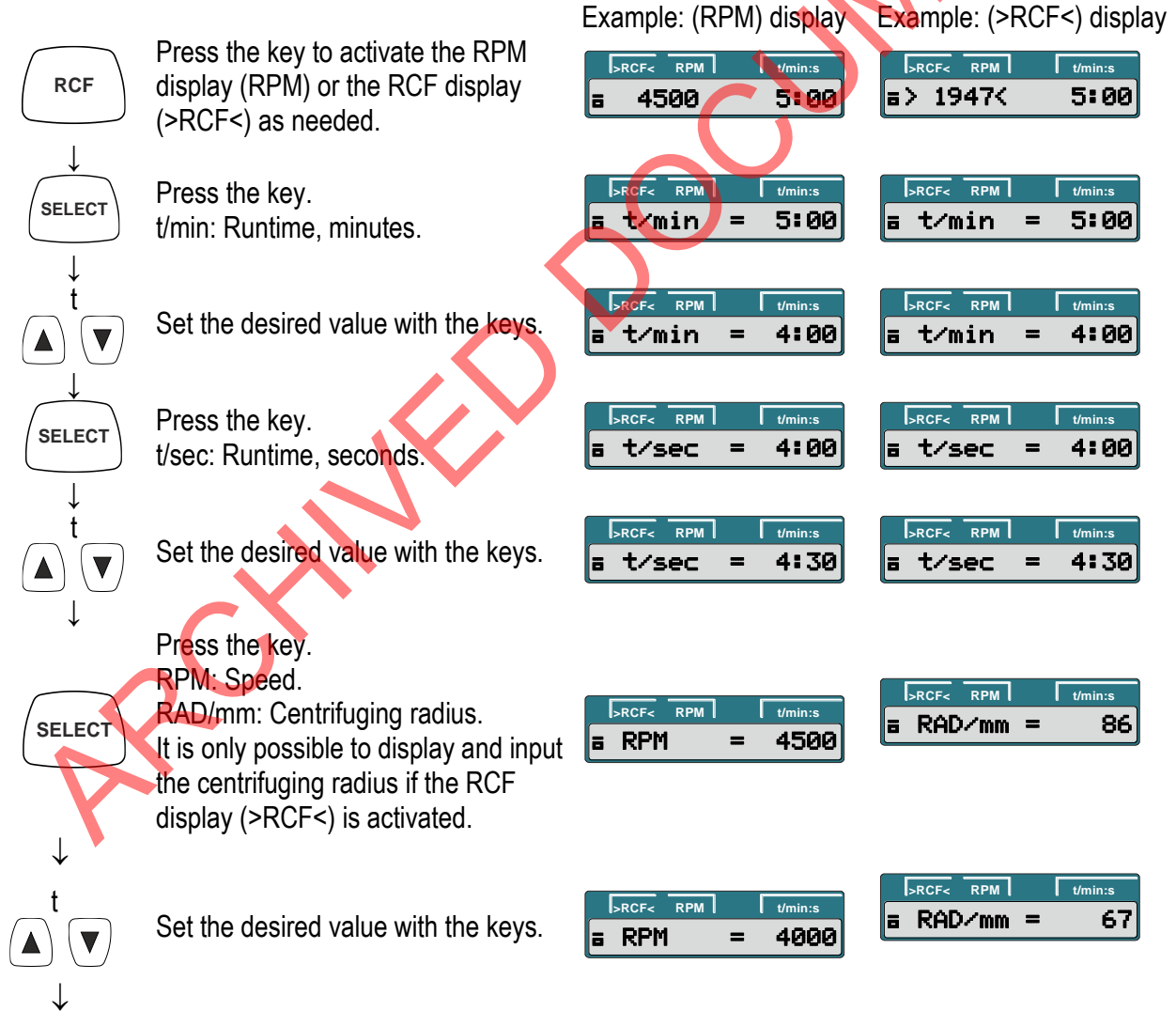

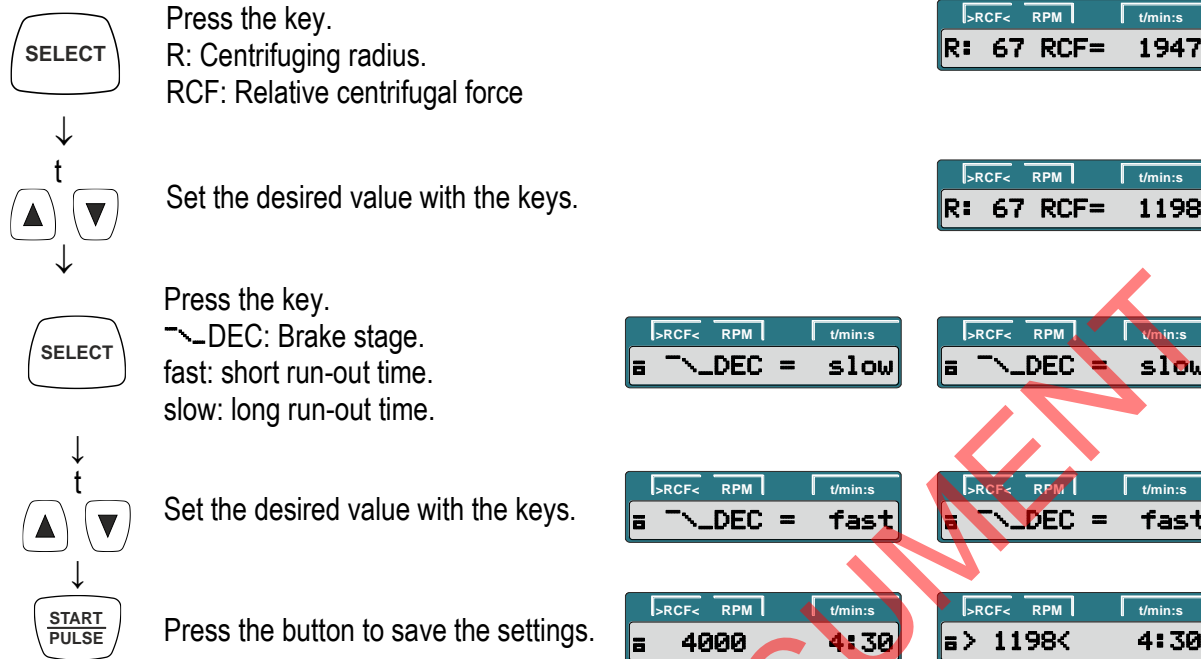

13.8 CONTROL PANEL DISPLAY

After each centrifugation run, while the lid is unlocking, the remaining number of running cycles (centrifugation runs) will be briefly displayed.

Example:

If the permissible weight difference was exceeded within the rotor load, the centrifugation run is aborted during start-up and "IMBALANCE" will display.

Example:

A centrifugation run can be aborted at any time by pressing the key. During a centrifugation run, centrifugation parameters can be selected and changed. The changed values, however, only apply to the current centrifugation run and are not saved. With the key, you can toggle between the RPM display (RPM) and RCF display (>RCF<) at any time. If the RCF display (>RCF<) is modified, the centrifuging radius must be entered. Further operation of the centrifuge is then only possible after opening the lid. Operation errors and malfunctions will be shown.

Example:

13.9 CENTRIFUGATION WITH PRESET TIME

 Press the key to activate the RPM display (RPM) or the RCF display (>RCF<) as needed.

↓

Enter the desired centrifugation parameters.

↓

 Press the key to start the centrifugation run. During the centrifugation run, the rotor speed or the resulting RCF value and remaining time are displayed.

↓

After the time elapses or if the centrifugation run is aborted by pressing the  key, the run-out occurs with the set brake stage. The brake stage ~f is displayed.

Example: (RPM) display



Example: (>RCF<) display

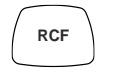

13.10 CONTINUOUS RUN

 Press the key to activate the RPM display (RPM) or the RCF display (>RCF<) as needed.

↓

Input the desired centrifugation parameters. Set the parameters t/min and t/sec to zero.

↓

 Press the key to start the centrifugation run. During the centrifugation run, the rotor speed or the resulting RCF value and elapsed time are displayed.

↓

 Press the key to end the centrifugation run. The run-out occurs with the set brake stage. The brake stage ~f is displayed.

Example: (RPM) display

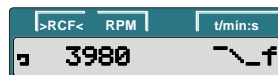
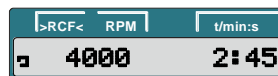

Example: (>RCF<) display

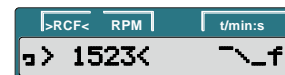
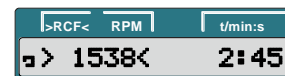
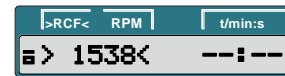

13.11 SHORT-TERM CENTRIFUGATION



Press the key to activate the RPM display (RPM) or the RCF display (>RCF<) as needed.



Enter the desired centrifugation parameters.



Press the key and keep it pressed. During the centrifugation run, the rotor speed or the resulting RCF value and elapsed time are displayed.



Release the key again to end the centrifugation run. The run-out occurs with the set brake stage. The brake stage ~_f is displayed.

Example: (RPM) display

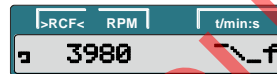

Example: (>RCF<) display



13.12 EMERGENCY STOP



Press the key twice. During the Emergency Stop, the run-out occurs with the "fast" brake stage (short run-out time). Brake stage ~_f is displayed.

Example: (RPM) display



Example: (>RCF<) display



13.13 CYCLE COUNTER

The centrifuge is equipped with a cycle counter, which counts the running cycles (centrifugation runs). After each centrifugation run, while the lid is unlocking, the remaining number of running cycles (centrifugation runs) will be briefly displayed.

Example:

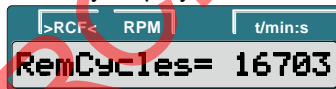









If the maximum permissible number of rotor running cycles has been exceeded, the following is displayed every time the centrifugation run is started. The centrifugation run must be restarted. The rotor must be immediately exchanged for a new rotor for safety reasons. After the rotor has been exchanged, the cycle counter must be reset to "0".

Example:



13.14 RESETTING THE CYCLE COUNTER TO ZERO

After the rotor has been exchanged, the cycle counter must be reset to zero again. The cycle counter may only be reset to zero if the rotor has been exchanged for a new rotor. With the rotor at a standstill, the cycle counter can be reset as shown below. The procedure can be aborted at any time by pressing the  key. In this case, the settings are not stored.

-  Press and hold the button for eight seconds.
- ↓
-  Press the key until the following is displayed.
- ↓
-  Press the key.
- ↓
-  Press the key until the following is displayed: Cyc sum: Number of completed run cycles.
- ↓
-  Press the key.
- ↓
-  Press the key. The number of completed run cycles is reset to zero.
- ↓
-  Press the button to save the setting.
- ↓
-  Press the key twice to exit the "-> Time & Cycles" menu or press three times to exit the "* MACHINE MENU *".



Example:



Example:



13.15 SETTINGS AND QUERIES

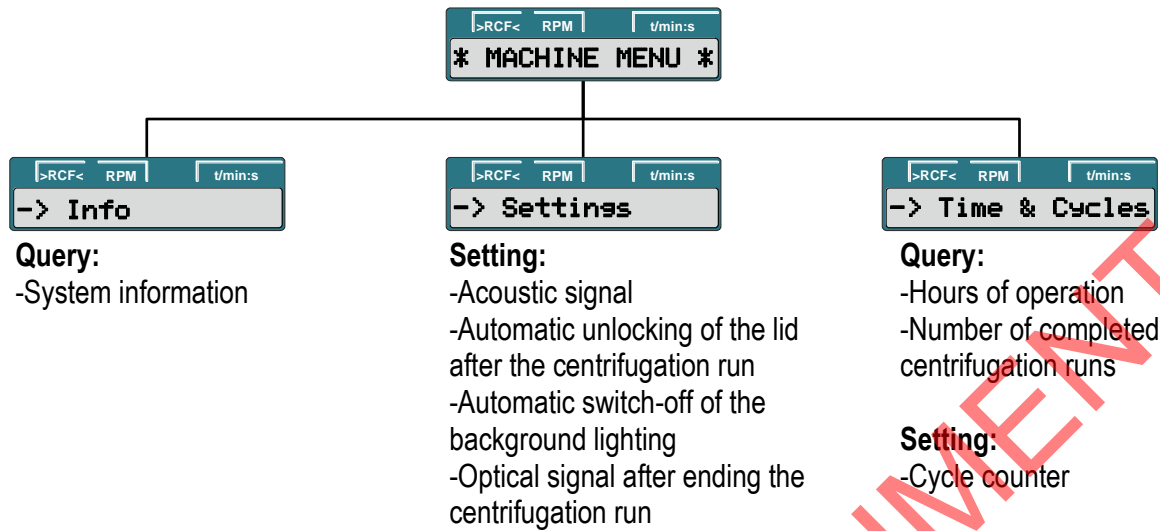

13.16 QUERYING SYSTEM INFORMATION

The following system information can be queried:

- Device model
- Program version of the device
- Type number of the device
- Device date of manufacture
- Device serial number
- Frequency converter type
- Frequency converter program version

With the rotor at a standstill, the query can proceed as follows: The procedure can be aborted at any time by pressing the  key.

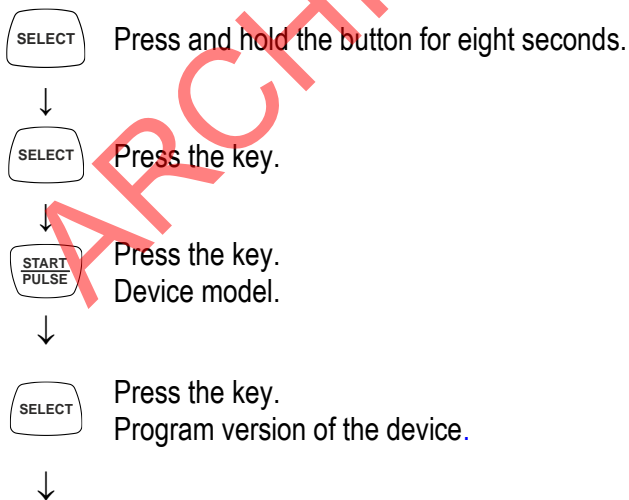

Example:

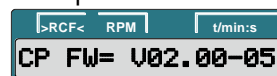



Press the key.
Type#1: Type number of the device.

Example:



Press the key.
Type#2: Continuation of the type number if this has more positions than the "Type#1" display field.

Example:

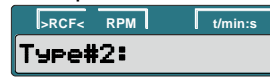

Press the key.
 Device date of manufacture.

Example:



Press the key.
 Device serial number.

Example:



Press the key.
 Frequency converter type.

Example:



Press the key.
 Frequency converter program version.

Example:



Press the key twice to exit the "-> Info" menu or press three times to exit the "* MACHINE MENU *".



Example:

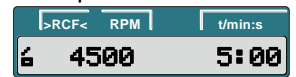

13.17 ACOUSTIC SIGNAL

The acoustic signal sounds (1) after a malfunction occurs in a 2-second interval and (2) after ending the centrifugation run and the rotor is at a standstill in a 30-second interval. The acoustic signal is ended by pressing any key. If the rotor is at a standstill, the acoustic signal can be set as follows. The procedure can be aborted at any time by pressing the  key. In this case, the settings are not stored.



Press and hold the button for eight seconds.



Press the key until the following is displayed.



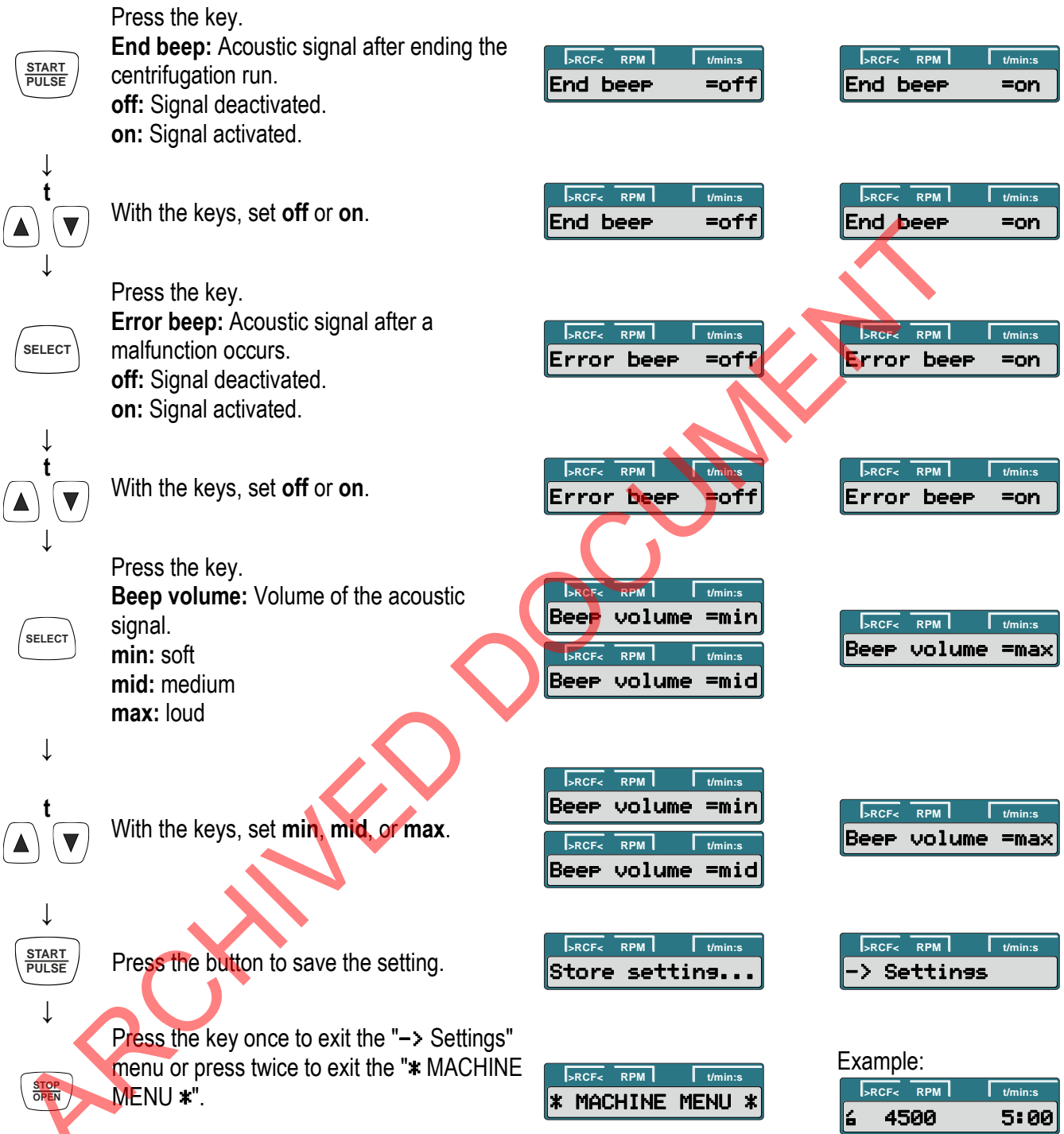

13.18 OPTICAL SIGNAL AFTER ENDING THE CENTRIFUGATION RUN

The backlighting of the display flashes after the centrifugation run to visually signalize that the centrifugation run has finished. The optical signal can be switched on or off when the rotor is at a standstill. The procedure can be aborted at any time by pressing the **STOP OPEN** key.

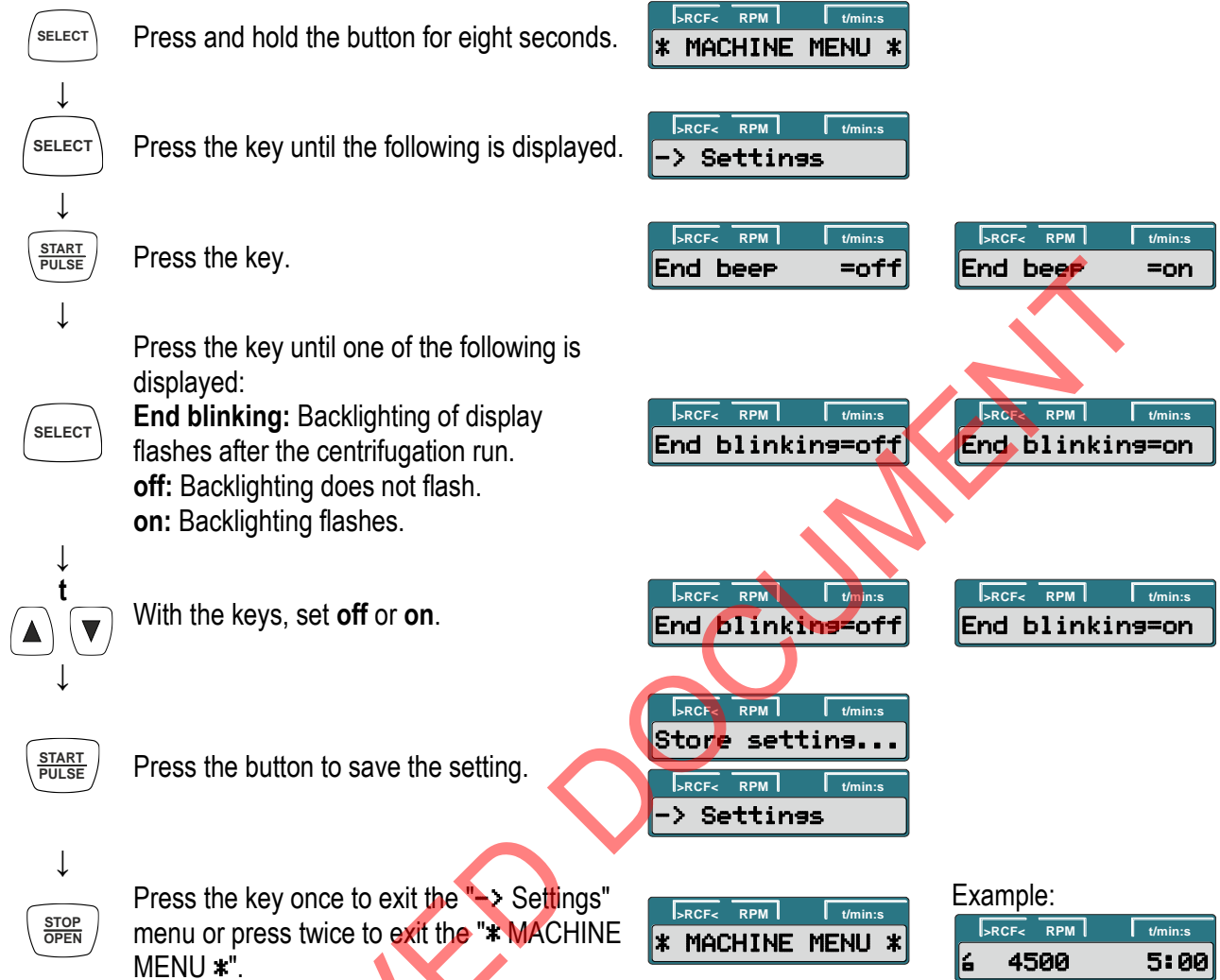

13.19 AUTOMATIC UNLOCKING OF THE LID AFTER THE CENTRIFUGATION RUN

It can be set whether the lid should automatically unlock or not after the centrifugation run. With the rotor at a standstill, this can be set as follows. The procedure can be aborted at any time by pressing the  key. In this case, the settings are not stored.

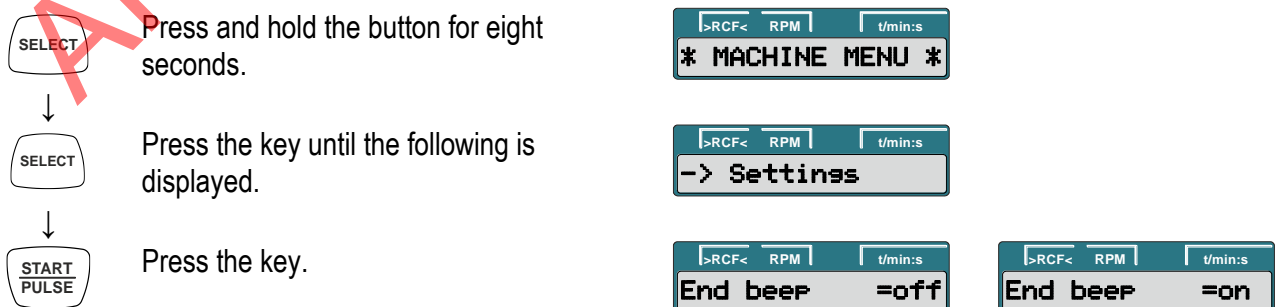

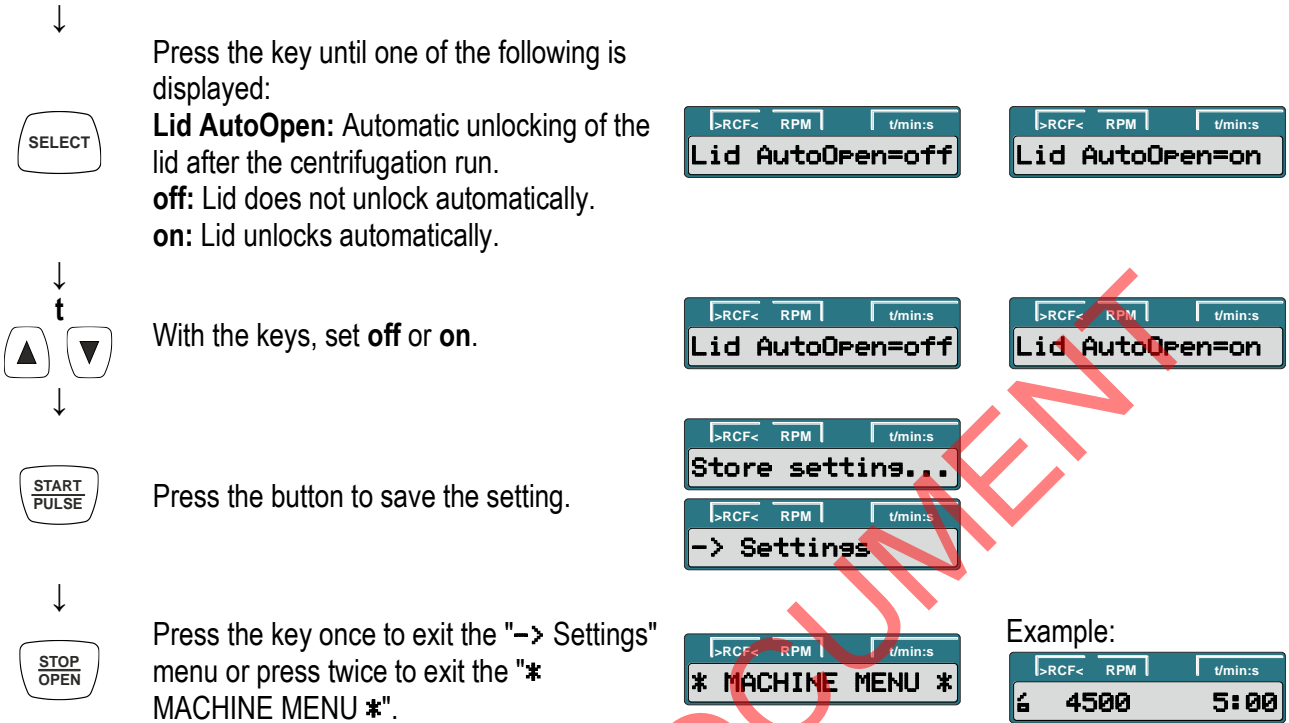

13.20 BACKLIGHTING OF THE DISPLAY

To save energy, it can be set that, after a centrifugation run, the backlighting of the display switches off after 2 minutes. With the rotor at a standstill, this can be set as follows. The procedure can be aborted at any time by pressing the **STOP OPEN** key. In this case, the settings are not stored.

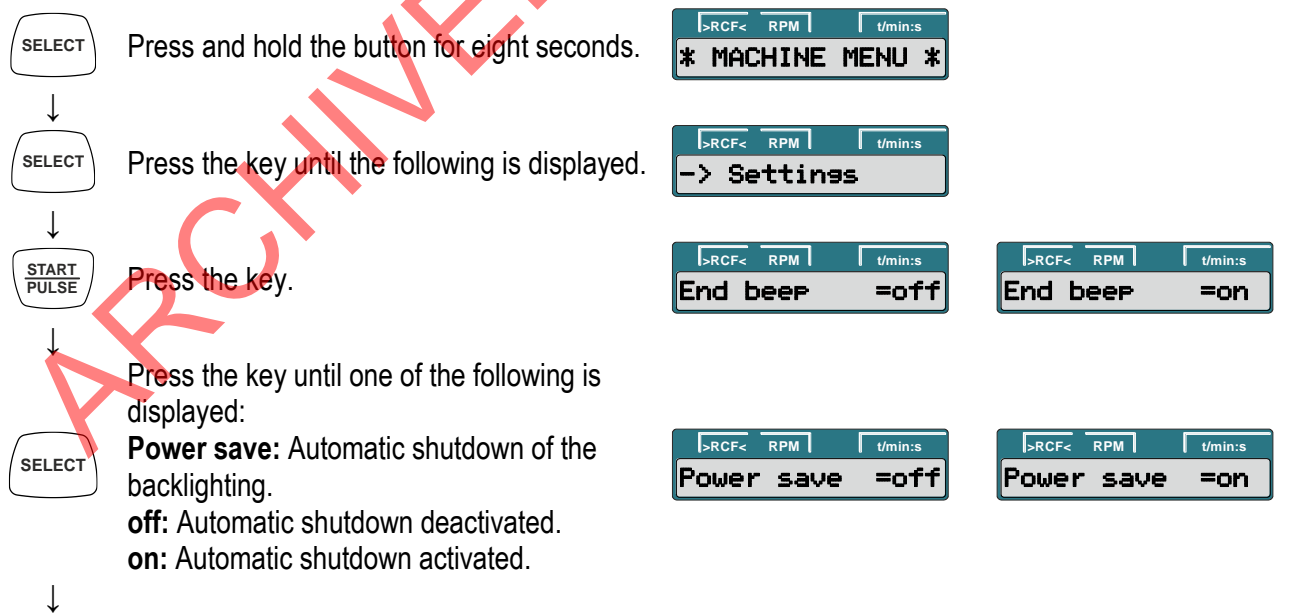

t

▲ ▼

With the keys, set **off** or **on**.

START PULSE

Press the button to save the setting.

STOP OPEN

Press the key once to exit the "-> Settings" menu or press twice to exit the "* MACHINE MENU *".

>RCF<	RPM	t/min:s
Power save	=off	

>RCF<	RPM	t/min:s
Power save	=on	

>RCF<	RPM	t/min:s
Store settings...		

>RCF<	RPM	t/min:s
-> Settings		

>RCF<	RPM	t/min:s
* MACHINE MENU *		

Example:

>RCF<	RPM	t/min:s
4500	5:00	

13.21 QUERYING THE HOURS OF OPERATION AND THE NUMBER OF CENTRIFUGATION RUNS

The hours of operation are divided into internal and external hours of operation. Internal hours of operation: Total time the device was switched on. External hours of operation: Total time of the previous centrifugation runs. With the rotor at a standstill, the query can proceed as follows. The procedure can be aborted at any time by pressing the **STOP OPEN** key.

SELECT

Press and hold the button for eight seconds.

SELECT

Press the key until the following is displayed.

START PULSE

Press the key.
TimeExt: External hours of operation.

SELECT

Press the key.
TimeInt: Internal hours of operation.

SELECT

Press the key.
Starts: Number of all centrifugation runs.

STOP OPEN

Press the key twice to exit the "-> Time & Cycles" menu or press three times to exit the "* MACHINE MENU *".

>RCF<	RPM	t/min:s
* MACHINE MENU *		

>RCF<	RPM	t/min:s
-> Time & Cycles		

Example:

>RCF<	RPM	t/min:s
TimeExt=	43 h	

Example:

>RCF<	RPM	t/min:s
TimeInt=	60 h	

Example:

>RCF<	RPM	t/min:s
Starts=	325	

Example:



>RCF<	RPM	t/min:s
4500	5:00	

14 FAULTS

If the fault cannot be eliminated with the help of the fault table below, please contact Customer Service and specify the type of centrifuge and the serial number. Both numbers can be found on the name plate of the centrifuge.



To perform a MAINS RESET: Switch off the mains switch (switch position "0"). Wait at least 10 seconds and then switch on the mains switch again (switch position "I").

Message / fault		Cause	Remedy
No display		No voltage Mains input fuses defective.	<ul style="list-style-type: none"> – Check distribution voltage. – Check mains power input fuse and refer to instructions for changing mains fuse. – Mains switch ON.
IMBALANCE		The rotor is unevenly loaded.	<ul style="list-style-type: none"> – Open the lid after the rotor is at a standstill. – Check the loading of the rotor. – Repeat the centrifugation run.
MAINS INTER	11	Power failure during the centrifugation run. (The centrifugation run was not finished.)	<ul style="list-style-type: none"> – Open the lid after the rotor is at a standstill. – Push start/pause button. – Repeat the centrifugation run if necessary.
MAINS INTERRUPT			
TACHO ERROR	1, 2	Failure of speed impulses during operation.	<ul style="list-style-type: none"> – Perform a MAINS RESET when the rotor has been stationary.
LID ERROR	4.1 – 4.127	Error in lid locking or lid closure.	
OVER SPEED	5	Rotation too fast	
VERSION ERROR	12	Incorrect centrifuge model recognized. Error / defect electronics	<ul style="list-style-type: none"> – Perform a MAINS RESET when the rotor has been stationary.
UNDER SPEED	13	Rotation too slow	
CTRL ERROR	22.1, 25.2	Error / defect of electronics	
CRC ERROR	27.1		
COM ERROR	31 – 36		
FC ERROR	60, 61.1 – 61.21, 61.64 – 61.142		
FC ERROR	61.23	Speed measurement error	<ul style="list-style-type: none"> – The device may not be switched off as long as the rotation display  is lit up and rotating. Wait until the symbol  (lid locked) is displayed (after approx. 120 seconds). Afterwards, carry out a MAINS RESET.
TACHO ERR	61.22		
FC ERROR	61.153	Error / defect of electronics	<ul style="list-style-type: none"> – Perform a MAINS RESET. – Check the loading of the rotor per the instructions provided. – Repeat the centrifugation run.

15 RELATIVE CENTRIFUGAL FORCE (RCF)

The relative centrifugal force (RCF) is given as a multiple of the acceleration of gravity (g). It is a unit-free value and serves to compare the separation and sedimentation performance. The relative centrifugal force (RCF) stands in relation to the revolutions per minute and the centrifugal radius. It can be calculated using the formula below:

$$RCF = \left(\frac{RPM}{1000}\right)^2 \times r \times 1.118 \Rightarrow RPM = \sqrt{\frac{RCF}{r \times 1.118}} \times 1000$$

RCF = relative centrifugal force

RPM = rotational speed (revolutions per minute)

r = centrifugal radius in mm = distance from the center of the turning axis to the bottom of the centrifuge container.

16 TRANSPORT AND STORAGE

Before transporting the device, the transport securing device must be installed. The device and the accessories may only be stored in closed and dry rooms. When the device and accessories are transported or stored, the following conditions must be complied with:

Temperature limits: -20°C to +60°C.

Relative Humidity limits: 10% to 80%, non-condensing.

17 CHANGE MAINS INPUT FUSES

Start by switching off the mains switch and separating the device from the mains. The fuse holder (A) with the mains input fuses is located next to the mains switch. Remove the connecting cable from the machine plug socket. Press the snap-fit (B) against the fuse holder (A) and remove. Exchange defective mains input fuses. Only use fuses with the rating defined for the centrifuge type provided by the manufacturer. Reinsert the fuse holder until the snap-fit clicks shut. Reconnect the device to the mains supply.

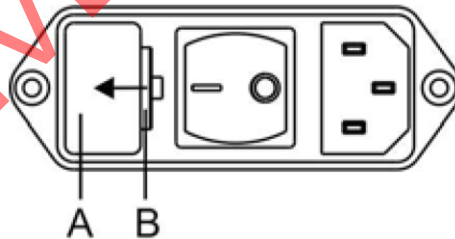

18 RETURNING DEVICES

Before returning the device, the transport securing device has to be installed. If the device or its accessories are returned to legal manufacturer, in order to provide protection for people, the environment and materials, it has to be decontaminated and cleaned before being shipped. The legal manufacturer reserves the right to refuse contaminated devices or accessories. Costs incurred for cleaning and disinfection are to be charged to the customer.

19 DISPOSAL

Before disposal, the device must be decontaminated and cleaned to protect people, the environment and property. When disposing of the device, the respective statutory rules must be observed. Pursuant to guideline 2002/96/EC (WEEE), all devices supplied after August 13, 2005 may not be disposed of as part of domestic waste. The device belongs to group 8 (medical devices) and is categorized in the business-to-business field. The icon of the crossed-out trashcan shows that the device may not be disposed of as domestic waste. The waste disposal guidelines of individual countries might vary. If necessary, contact your supplier.

ARCHIVED DOCUMENT



La tabla de símbolos de abajo es solo para referencia. Consulte la etiqueta del empaque del producto para ver los símbolos aplicables.

Símbolo	Descripción del símbolo
	Precaución
	Instrucciones de uso electrónicas
	Fabricante
	Los productos BioHorizons llevan la marca CE y cumplen con los requisitos de la Directiva de dispositivos médicos 93/42/EEC
	Número de referencia/artículo
	Número de lote/partida
	No reutilizar
	No reesterilizar.
	Fecha de caducidad
	Estéril por radiación gamma
	Fecha de fabricación
	Precaución: La ley federal de EE. UU. restringe la venta, distribución y uso de estos dispositivos a dentistas o médicos, o por prescripción suya

Símbolo	Descripción del símbolo
	Posición de inicio principal
	No use si el paquete está dañado
	Dispositivo médico
	No estéril
	Mantener seco
	Frágil; tratar con cuidado
	Límites de temperatura
	Este lado hacia arriba
	Límites de humedad
	Advertencia; Riesgo biológico
	Notas importantes
	Recogida selectiva de dispositivos eléctricos y electrónicos.
	Representante autorizado en la Comunidad Europea.

1 INDICACIONES DE USO

El sistema IntraSpin está diseñado para utilizarse en la preparación rápida y segura de fibrina rica en plaquetas (L-PRF, por sus siglas en inglés) autóloga a partir de una pequeña muestra de sangre en el punto de atención del paciente. La L-PRF se mezcla con el hueso del aloinjerto o el autoinjerto antes de la aplicación a un defecto óseo para mejorar las características de manipulación. Observar toda la información en las Instrucciones de uso también es parte del uso previsto.

2 CONTRAINDICACIONES

La centrífuga IntraSpin solo está diseñada para el propósito establecido en el uso previsto del dispositivo. Cualquier otro uso del dispositivo se considera no intencionado. El uso de la centrífuga IntraSpin está contraindicado en presencia de una o más de las siguientes situaciones clínicas: pacientes con adicción al alcohol o trastornos psiquiátricos, discrasias sanguíneas, diabetes no controlada, hipertiroidismo, infecciones orales, tumores malignos o pacientes que han tenido infarto de miocardio en el último 12 meses. Pacientes con enfermedades sistémicas que comprometen el sistema inmunitario, como el SIDA, pacientes que toman medicamentos que comprometerían la cicatrización de un sitio de implante, pacientes con antecedentes de insuficiencia o incumplimiento de los procedimientos de higiene oral.

Pacientes que participan en la terapia anticoagulante. Estos pacientes no están excluidos de los beneficios de PRF, sino que el punto de atención debe agregar tiempo adicional a la centrífuga para que la separación sea efectiva para su uso.



3 NOTAS DE SEGURIDAD

- El fabricante no considerará ningún reclamo de garantía a menos que se hayan seguido TODAS las instrucciones de este manual.
- Las instrucciones de funcionamiento son parte del dispositivo. Siempre deben mantenerse disponibles. Si el dispositivo está configurado en una ubicación diferente, se deben proporcionar las instrucciones de funcionamiento.
- La centrífuga debe instalarse en una buena base estable.
- Antes de usar la centrífuga, compruebe absolutamente el rotor para una colocación firme.
- Cuando la centrífuga está funcionando, ninguna persona, sustancias u objetos peligrosos pueden estar dentro del margen de seguridad de 300 mm alrededor de la centrífuga.
- Los rotores, suspensiones y accesorios que poseen rastros de corrosión o daños mecánicos o si su período de uso ha expirado ya no se pueden usar.
- La centrífuga ya no se puede poner en funcionamiento cuando la cámara de centrifugación tiene daños relacionados con la seguridad.
- Para centrifugadoras sin control de temperatura, cuando la temperatura ambiente aumenta y / o si el dispositivo se usa con frecuencia, la cámara de centrifugación podría calentarse. Por lo tanto, no se puede descartar que el material de la muestra se pueda cambiar debido a la temperatura.
- Antes de la operación inicial de su centrífuga, debe leer y prestar atención a las instrucciones de operación. Solo el personal que haya leído y entendido las instrucciones de operación puede operar el dispositivo.
- Junto con las instrucciones de funcionamiento y las normas legales sobre prevención de accidentes, también debe seguir las normas profesionales reconocidas para trabajar de manera segura y profesional. Estas instrucciones de funcionamiento deben leerse junto con otras instrucciones relacionadas con la prevención de accidentes y la protección del medio ambiente de acuerdo con las normativas nacionales del país donde se utilizará el dispositivo.

- El cumplimiento de los requisitos específicos del país con respecto a la seguridad laboral con respecto al uso de centrifugadoras en los lugares de trabajo provistos para este propósito por el usuario es responsabilidad del usuario.
- Esta centrifuga es un equipo de última generación que es extremadamente seguro de operar. Sin embargo, puede generar peligro para los usuarios u otras personas si es utilizado por personal no capacitado, de manera inapropiada o para un propósito diferente al que fue diseñado.
- La centrifuga no debe moverse ni golpearse durante el funcionamiento.
- En caso de falla o liberación de emergencia, nunca toque el rotor antes de que haya dejado de girar.
- Para evitar daños debido al condensado, al cambiar de una habitación fría a una cálida, la centrifuga debe calentarse durante al menos 3 horas en la habitación cálida antes de conectarse a la red eléctrica o calentarse durante 30 minutos en la habitación fría.
- Cuando se centrifuga con revoluciones máximas por minuto, la densidad de los materiales o las mezclas de materiales no puede exceder los 1,2 kg / dm³.
- La centrifuga solo puede funcionar cuando la balanza está dentro de los límites de aceptabilidad.
- La centrifuga no puede funcionar en áreas en peligro de explosión.
- La centrifuga no debe usarse con materiales inflamables o explosivos o materiales que reaccionan entre sí produciendo mucha energía.
- No hay sistemas de bioseguridad disponibles para esta centrifuga.
- La centrifuga no debe funcionar con sustancias altamente corrosivas que puedan dañar la integridad mecánica de rotores, colgadores y accesorios.
- Las reparaciones solo deben ser realizadas por personal autorizado por el fabricante.
- Para ofrecer a los pacientes el más alto nivel de seguridad clínica, los productos IntraSpin están hechos con materiales que son biocompatibles con plasma humano.
- Este producto no está autorizado para la venta en todos los mercados y es posible que no esté disponible en su mercado. Consulte con su representante local para obtener información adicional.

4 COMPONENTES DEL SISTEMA INTRASPIN

COMPONENTE	CANTIDAD POR SISTEMA
IntraSpin Centrifuga incluyendo:	1
Cable de energía	1
Fusible	2
Llave hexagonal	1
Tubos de recogida de sangre y tubos de equilibrio Greiner (de un solo uso)	150
Conjunto de recogida de sangre de seguridad Greiner + soporte, 21G (un solo uso)	24
Torniquete libre de látex	1
Gradilla	1
Tijeras Curvas Quirúrgicas	1
Pinzas de tejido quirúrgico	1
Cuenco redondo de acero inoxidable	1
Cuenco rectangular de acero inoxidable	1
Espátula de doble portador de biomaterial	1
Empaquetador dual de biomaterial	1
Caja Xpression®	1

Solo se recomiendan y garantizan componentes compatibles verificados para uso directo con la centrifuga IntraSpin:

# DE PIEZA COMPATIBLE	DESCRIPCIÓN
455092	Red Cap 9ml CAT Serum Clot activator tubes
455001	White Cap 9ml Z No additive tubes
BHEXZ (E613)	IntraSpin Hex Key, 110v & 220v
BROTORZ (E3694)	IntraSpin Rotor, 100v & 220v
BPOWER110Z (E1673)	IntraSpin Power Cord, 110v
BPOWER220Z (E1669)	IntraSpin Power Cord, 220v
BTUBEHOLDZ (E872 x 1)	IntraSpin Tube Holder Replacement
BFUSE110Z (E997)	IntraSpin Fuse 110v
BFUSE220Z (E891)	IntraSpin Fuse 220v

5 BREVE CONFIGURACIÓN DE LA CENTRIFUGA

Retire y guarde los pernos de transporte del fondo de la centrifuga.

Conecte el cable de CA y conéctelo a la toma de corriente.

Encienda la centrifuga utilizando el interruptor basculante en la parte posterior del dispositivo.

Seleccione velocidad y tiempo: Velocidad = 2700 y Tiempo = 12:00 min.

Presiona START.

La cubierta de la centrifuga se abrirá automáticamente al final de cada ciclo.

Después del primer procedimiento, el tiempo y la velocidad se registran en la memoria de la centrifuga a menos que se modifique la configuración.

6 PRECAUCIONES E INSTRUCCIONES PARA LOS TUBOS DE RECOGIDA DE SANGRE Y EL CONJUNTO DE RECOGIDA DE SANGRE

- No utilice los tubos si hay presencia de sustancias extrañas.
- Se debe permitir que los tubos de recogida de sangre se llenen completamente.
- Manipule todas las muestras biológicas y los elementos "punzantes" para la recogida de sangre (por ejemplo, agujas y conjuntos de recogida de sangre) de acuerdo con las políticas y los procedimientos de su centro.
- No doble la aguja.
- No utilice la fuerza para liberar ni reactivar el mecanismo de seguridad de la aguja después de haberlo activado.
- Obtenga atención médica adecuada en el caso de cualquier exposición a muestras biológicas (por ejemplo, a través de una lesión por punción) debido a la posible transmisión del VIH (SIDA), hepatitis viral u otras enfermedades infecciosas.
- Deseche todos los objetos punzantes de recolección de sangre en recipientes de riesgo biológico aprobados.
- Transferir una muestra de una jeringa a un tubo no es un procedimiento recomendado.
- Si se recolecta sangre a través de una línea intravenosa (IV), siga las políticas y procedimientos de su institución para asegurarse de que la línea haya sido limpiada de solución IV antes de comenzar a llenar los tubos de recolección de sangre.
- El acelerador de la coagulación de la sangre puede aparecer blanco en la superficie del tubo, lo que no tiene ningún efecto sobre el rendimiento de los tubos. Si cualquier otra decoloración o precipitado está presente en el tubo, no debe usarse.
- No use los tubos después de la fecha de vencimiento.

- Almacene los tubos de recogida de sangre a una temperatura entre 4 y 25 °C (40 y 77 °F).
- Almacene el conjunto de recogida de sangre (aguja y soporte) a una temperatura entre 4 y 36 °C (40 y 97 °F).
- Evite la exposición a la luz solar directa. Exceder la temperatura de almacenamiento máxima recomendada puede afectar la calidad del tubo (es decir, pérdida de vacío, coloración, etc.).
- Para evitar el reflujo, coloque el brazo del paciente en una posición hacia abajo, sostenga el tubo con la tapa hacia arriba, suelte el torniquete tan pronto como la sangre comience a fluir hacia el tubo, evite que el contenido del tubo entre en contacto con la tapa o el extremo de la aguja durante Venopunción.
- Asegúrese de que los siguientes materiales sean fácilmente accesibles antes de realizar la punción venosa: todos los tubos de extracción de sangre necesarios, etiquetas identificadas para la identificación positiva del paciente de las muestras, agujas y soportes de extracción de sangre, hisopo con alcohol para limpiar el sitio de la punción, gasa limpia, torniquete, yeso adhesivo o vendaje, contenedor de riesgo biológico aprobado. Para la protección contra la exposición a patógenos transmitidos por la sangre, se recomienda el uso de EPP (equipo de protección personal) adecuado (por ejemplo, guantes, bata de laboratorio, gafas, etc.).

Técnica de venopunción y recolección de muestras de sangre:

La recolección de sangre debe realizarse lo más rápido posible, ya que no hay anticoagulante en los tubos de recolección. La muestra de sangre comenzará a coagularse inmediatamente. Use guantes durante la punción venosa y al manipular tubos de recolección de sangre para minimizar el riesgo de exposición. Antes de la extracción de sangre, limpie la parte superior de la (s) tapa (s) del tubo de sangre con una toallita desinfectante de su elección. Retire la cubierta sobre la sección de la válvula de la aguja. Prepare el sitio de punción venosa con un antiséptico apropiado. No palpe el área de la venopunción después de la limpieza. Coloque el brazo del paciente en una posición hacia abajo. Retire el protector de la aguja. Realice la punción venosa con el brazo hacia abajo y la tapa del tubo en la parte superior. Inmovilice la aguja con cinta en caso de que sea necesario. Empuje el tubo de extracción de sangre dentro del soporte y sobre la válvula de aguja perforando el diafragma de goma del tubo de extracción de sangre. Centre los tubos de recolección de sangre en el soporte cuando penetre la tapa para evitar la penetración de la pared lateral y la consiguiente pérdida prematura del vacío. Retire el torniquete tan pronto como aparezca sangre en el tubo de recolección de sangre. Durante el procedimiento, siempre sostenga el tubo de recolección en su lugar presionándolo con el pulgar. Esto asegurará un vacío completo. El tubo de recolección de sangre se llenará automáticamente. Si no fluye sangre al tubo de recolección o si el flujo de sangre cesa antes de recolectar una muestra adecuada, se sugieren los siguientes pasos para completar una recolección satisfactoria:

- Empuje el tubo de extracción de sangre hacia adelante para asegurarse de que la tapa haya sido penetrada.
- Confirme la posición correcta de la aguja en la vena.
- Si la sangre aún no fluye, retire y deseche adecuadamente el tubo de recolección. Obtenga un nuevo tubo de recolección y empuje dentro del soporte.
- Si el segundo tubo de recolección no se estira, retire y deseche adecuadamente la aguja y el tubo de recolección. Repite el procedimiento.
- Cuando se haya alcanzado la línea de llenado de volumen máximo del tubo de extracción de sangre, retírela suavemente del soporte. Repita con un segundo tubo de extracción de sangre.

Invierta suavemente cada tubo de recolección inmediatamente después de retirarlo del soporte. No agite los tubos llenos de muestra de sangre. La mezcla vigorosa puede causar espuma o hemólisis. La mezcla insuficiente o la mezcla retrasada en los tubos de suero pueden provocar una coagulación retrasada.

Una vez finalizada la recogida de muestras de sangre, retire la aguja de la vena. Active el mecanismo de seguridad (protector de seguridad) de la aguja al presionar a ambos lados del cuerpo para activar el bloqueo. Deslice el mecanismo de seguridad hacia atrás hasta que escuche un clic. No vuelva a tapar la aguja, ya que esto aumenta el riesgo de lesión por pinchazo de la aguja y exposición a la sangre. Deseche la aguja usada con su soporte en un recipiente adecuado para desechos de productos biopeligrosos. Aplique presión en el sitio de punción con un hisopo estéril seco hasta que se detenga el sangrado. Si lo desea, aplique una venda una vez que se haya producido la coagulación. Se recomienda que los tubos de recolección llenos se mantengan en posición vertical. Una vez que el segundo tubo de recolección de sangre esté lleno, retírelo y coloque el primer y segundo tubo en la centrífuga en lugares opuestos para contrarrestar el rotor. Cierre la tapa de la centrífuga IntraSpin y presione el botón START para permitir que gire durante 12 minutos.

Si se necesitan más de dos tubos de sangre, siga este procedimiento alternativo: después de que se recojan los dos primeros tubos de sangre y se inviertan suavemente, colóquelos inmediatamente en la centrifugadora IntraSpin, en posiciones opuestas con respecto al otro, para asegurarse de que la centrifugadora esté bien equilibrada. Cierre la cubierta y presione el botón START y permita que la centrifuga funcione mientras recolecta los tubos de sangre restantes. Presione el botón STOP y permita que la centrifuga se detenga por completo. La tapa se abrirá; coloque inmediatamente los tubos restantes en la centrifuga uno frente al otro para garantizar un equilibrio adecuado y presione el botón START para reiniciar y completar el protocolo recomendado. Coloque siempre los tubos en pares y colóquelos en posiciones opuestas para equilibrar el rotor de la centrifuga. Los tubos siempre deben estar equilibrados en el rotor antes de presionar el botón de START o esto puede causar daños graves a la centrifuga, coagulación inadecuada y / o separación. Si los tubos no están equilibrados adecuadamente, habrá demasiada vibración durante la centrifugación y se producirá un coágulo de fibrina L-PRF deficiente. Si tiene un número impar de muestras de sangre para centrifugar, coloque un tubo de equilibrio con tapa blanca (por ejemplo, 455001) lleno de agua hasta la línea de llenado máximo indicada, en la posición opuesta al tubo no emparejado en el rotor. Esto permitirá el equilibrio adecuado de la centrifugadora. Comience la centrifugación inmediatamente después de recolectar las muestras de sangre. Los retrasos afectan el procedimiento de separación de la sangre y dan como resultado un coágulo de fibrina L-PRF deficiente.

7 PREPARACIÓN DE L-PRF

Después de la centrifugación, son visibles tres segmentos:

1. Segmento superior = plasma pobre en plaquetas (PPP).
2. Segmento medio = coágulo de fibrina: L-PRF.
3. Segmento inferior = Coágulo de glóbulos rojos.

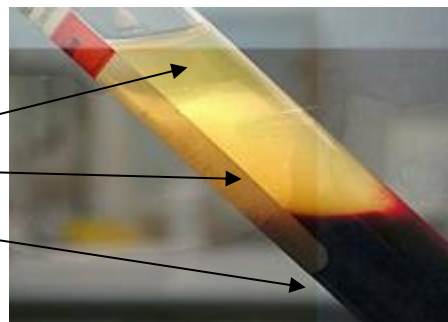

Las membranas o tapones de fibrina L-PRF deben prepararse con relativa rapidez: 0-15 minutos después de la centrifugación o el coágulo se reducirá en volumen al liberar el suero atrapado. Después de la centrifugación, retire el tapón de goma de cada tubo. Con las pinzas de tejido quirúrgico, retire el coágulo L-PRF del tubo. Raspe suavemente el coágulo de glóbulos rojos del coágulo de fibrina L-PRF® justo debajo de la unión, utilizando la espátula portadora de biomaterial dual, de modo que solo una cantidad mínima residual de glóbulos rojos se adhiera al coágulo L-PRF. Coloque el coágulo de fibrina en la bandeja perforada Xpression.

8 PREPARACIÓN DE LA MATRIZ DE FIBRINA

Protocolo #1 Membrana L-PRF

Coloque cada uno de los coágulos de fibrina en la bandeja perforada Xpression. Una vez que se colocan todos los coágulos de fibrina, coloque la placa de compresión Xpression y la cubierta ponderada Xpression sobre los coágulos de fibrina sin ejercer presión sobre los coágulos.

Permita que el peso de la cubierta presione lentamente el coágulo de fibrina mientras el exudado se filtra al fondo de la bandeja. No aplique presión a la cubierta con peso. La fuerza gravitacional sobre la cubierta ponderada comprimirá suavemente el coágulo y expresará el suero del coágulo L-PRF sin dañar la red de fibrina.

Espere al menos 5 minutos antes de retirar y usar las membranas de fibrina. No quite las membranas de fibrina hasta el momento real de uso. La membrana de fibrina puede permanecer en el cuadro de expresión durante un período de hasta 3 horas.

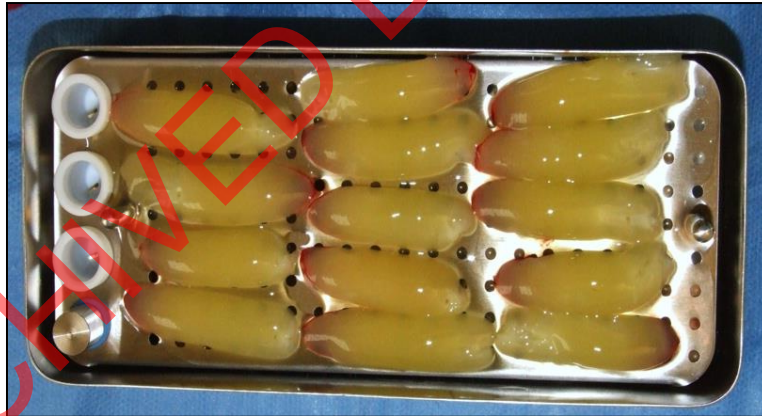

Protocolo #2 Enchufe L-PRF

Coloque un coágulo de fibrina dentro del cilindro de fabricación de tapón blanco. Use el pistón para presionar lentamente el coágulo dentro del cilindro blanco de fabricación de tapones L-PRF. Continúe presionando hasta que el borde superior del pistón esté al ras con el borde superior del cilindro blanco de fabricación de tapones L-PRF. Con esta técnica, se podrá formar un tapón de fibrina redondo y grueso para el receptáculo de extracción. Para un solo diente, un tapón L-PRF puede ser suficiente. Los premolares pueden necesitar dos tapones de L-PRF, y tres tapones de L-PRF pueden ser necesarios para los molares, dependiendo del tamaño de la cavidad de extracción y del tamaño del coágulo de fibrina creado.

Las propiedades de trabajo de L-PRF proporcionan un medio excelente para usar en combinación con su biomaterial de preferencia. Utilizando cualquiera de los siguientes protocolos de mezcla, el biomaterial se captura en la matriz de fibrina aumentando su manejo y capacidad biológica.

Protocolo #3- Mezcla de Biomaterial y L-PRF

Para crear una mezcla de "masilla como" que se pueda formar suavemente con el instrumento de biomaterial en la forma y grosor deseados, utilice el siguiente protocolo: Corte suavemente la membrana de fibrina L-PRF en trozos pequeños en un plato estéril con las tijeras curvas quirúrgicas. Agregue la cantidad deseada de material de injerto óseo. Mezcle completamente el L-PRF y el material de injerto óseo. Esta mezcla se puede colocar en defectos usando la espátula portadora de biomaterial dual.



Protocolo #4- Mezcla de Matriz de Biomaterial y L-PRF

Coloque la cantidad predeterminada de material de injerto óseo en un recipiente o bandeja estéril. Sumerja la (s) membrana (s) L-PRF expresada o piezas de la membrana L-PRF en el material del injerto que cubre toda la superficie de la membrana L-PRF con material de injerto. Alternativamente, el material de injerto se puede rociar sobre la membrana L-PRF que cubre toda la superficie con material de injerto. Nota: Una membrana L-PRF más húmeda puede retener un poco más de material de injerto que una membrana L-PRF más seca. El material del injerto debe adherirse a la superficie del L-PRF; sin embargo, si lo desea, presione suavemente el material del injerto sobre la membrana del L-PRF. Las pinzas de tejido quirúrgico se pueden utilizar para colocar esta mezcla en el defecto.

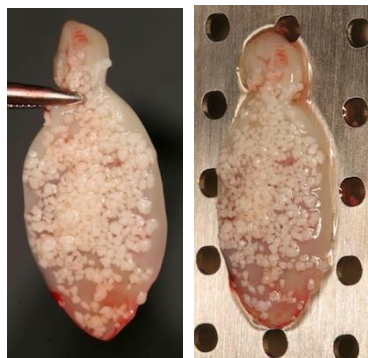

Protocolo #5- Hidratación Biomaterial

Agregue la cantidad deseada de material de injerto óseo en un recipiente o bandeja estéril. Utilice el exudado del fondo de la Bandeja de la Colección Xpression para hidratar el material del injerto. Mezcle bien el exudado y el material de injerto óseo. Esta mezcla se puede colocar en defectos usando la espátula portadora de biomaterial dual.

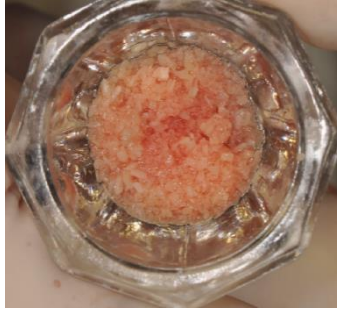

9 KIT DE REGENERACIÓN DE TEJIDOS LIMPIEZA Y ESTERILIZACIÓN

La caja de Xpression permite fabricar matrices de fibrina de grosor constante con facilidad. El exudado se puede recoger de la Bandeja de Colección Xpression, debajo de la Bandeja Perforada de Xpression. La Xpression Box incluye cilindros de fabricación de tapones L-PRF y un pistón para fabricar tapones L-PRF que se ajustan fácilmente a los enchufes posteriores a la extracción.



Cubierta ponderada por expresión



Placa de compresión Xpression



Bandeja perforada Xpression en la bandeja de colección Xpression

La caja de expresión y los instrumentos auxiliares NO se suministran estériles. Retire y deseche cualquier material de envío antes de la esterilización inicial. Limpie y esterilice la Xpression Box y los instrumentos auxiliares antes de cada uso.

Desmonte la Xpression Box antes de cada ciclo de limpieza y esterilización para evitar la encapsulación de residuos, la decoloración del material y / o el secado inadecuado de los componentes. Los cilindros de fabricación de tapones L-PRF y la arandela de pistón no están destinados a ser retirados de la bandeja perforada Xpression para su limpieza y esterilización.

Limpieza: (1) Elimine cualquier residuo visible de los componentes de la caja de expresión y los instrumentos auxiliares con un cepillo de cerdas suaves y un agente de limpieza o desinfección de amplio espectro como Hu-Friedy's Enzymax® o equivalente. Enjuague bien. (2) Coloque los componentes de la caja de expresión

y los instrumentos auxiliares en un recipiente del tamaño adecuado de la misma solución y sonique durante 10 minutos. Enjuague bien. (3) Enjuague los componentes de la caja de expresión y los instrumentos auxiliares con alcohol isopropílico para eliminar cualquier residuo de jabón y minerales. (4) Seque los componentes de la caja de expresión y los instrumentos auxiliares con una toalla sin pelusa y séquelos completamente al aire. Consulte las etiquetas del agente de limpieza utilizado para obtener instrucciones de uso.

Esterilización: (1) Coloque la caja de Xpression reensamblada y los instrumentos auxiliares en una bolsa o envoltura de esterilización aprobada por la FDA. (2) Ejecute uno de los siguientes ciclos de esterilización calificados:

Método De Esterilización	Temperatura	Tiempo De Exposición	Tiempo De Secado Mínimo
Vapor De Prevacío (ANSI/AAMI ST79)	132°C (270°F)	4min	20-30 minutos
Vapor De Prevacío (UK DoH Health Technical Memorandum 01-01)	134°C (273°F)	3min	20-30 minutos

¡Atención! Una limpieza inadecuada puede conducir a una esterilización inadecuada. Si no se seca completamente los componentes de la caja de expresión y los instrumentos auxiliares durante la esterilización en autoclave, puede dejar humedad y causar decoloración y oxidación. El uso de peróxido de hidrógeno u otros agentes oxidantes dañará la superficie de los componentes de la caja de expresión y los instrumentos auxiliares. Se recomienda realizar pruebas, limpiezas y calibraciones periódicas del equipo de autoclave para garantizar que la unidad siga funcionando correctamente.

10 LIMPIEZA Y MANTENIMIENTO CENTRIFUGADO

El aparato puede estar contaminado. Antes de la limpieza quitar el enchufe de la red. No está permitido limpiar las centrifugas, los rotores y los accesorios en lavavajillas. Solamente está permitido realizar una limpieza manual y una desinfección líquida. La temperatura del agua debe tener un valor de 20 – 25 °C. Solo se pueden utilizar detergentes / desinfectantes con un pH entre 5 - 8 y que no contengan álcalis cáusticos, peróxidos, compuestos de cloro, ácidos y soluciones alcalinas. Para evitar la aparición de corrosión a través de agentes de limpieza o desinfectantes, debe considerarse la guía de aplicación del fabricante del agente de limpieza o desinfectante.

Limpiar con regularidad la caja de la centrífuga y la cámara de centrifugado y en caso de ser necesario limpiar con jabón o un producto de limpieza suave y un paño húmedo para evitar la corrosión por impurezas adherentes. Los ingredientes de los detergentes adecuados incluyen jabón, tensioactivos aniónicos y tensioactivos no iónicos. Después de utilizar limpiadores, se deben eliminar los residuos limpiando con un paño húmedo. Las superficies deben secarse inmediatamente después de la limpieza. Secar la condensación en el espacio de centrifugado pasando un paño absorbente. Untar ligeramente la obturación de goma del espacio de centrifugado después de cada limpieza con polvos talcos o un producto de conservación de la goma. La cámara de centrifugación se debe verificar en busca de daños. Si se determinan daños que afecten la seguridad, la centrífuga no se debe colocar más en servicio. En este caso, debe informarse a la sección de servicio al cliente.

Para la desinfección de la superficie, si los materiales infecciosos penetran en la cámara centrífuga, debe desinfectarse de inmediato. Los ingredientes de desinfectantes adecuados incluyen etanol, n-propanol, etil hexanol, tensioactivos aniónicos e inhibidores de corrosión. Después de utilizar desinfectantes, deben eliminarse los residuos limpiando con un paño húmedo. Las superficies deben secarse inmediatamente después de la desinfección.

Para eliminación de impurezas radioactivas, el medio debe estar certificado de forma especial para la eliminación de impurezas radioactivas. Los ingredientes de agentes adecuados para eliminar contaminantes radiactivos incluyen tensioactivos aniónicos, tensioactivos no iónicos, etanol polihidratado. Después de eliminar las impurezas radioactivas, los residuos del medio de limpieza deben eliminarse con un paño húmedo. Las superficies deben secarse inmediatamente después de eliminar las impurezas radioactivas.

11 ROTOR Y ACCESORIOS LIMPIEZA Y MANTENIMIENTO

Con el fin de prevenir corrosión y alteraciones del material, el rotor y los accesorios se tienen que limpiar regularmente con jabón o un producto de limpieza suave y un paño húmedo. Se recomienda la limpieza mínimo una vez a la semana. Ensuciamientos deben eliminarse de inmediato.

Substancias contenidas en limpiadores adecuados incluye jabón, tensioactivos aniónicos y tensioactivos no iónicos. Después de utilizar limpiadores, deben eliminarse los residuos lavando con agua (solo en el exterior de la centrífuga) o limpiando con un paño húmedo. El rotor y los accesorios se tienen que secar inmediatamente después de la limpieza. El rotor y los accesorios deben controlarse semanalmente en cuanto a desgaste y deterioros por corrosión. En caso de signos de desgaste o corrosión, no se pueden emplear más el rotor y el accesorio. Comprobar cada semana que el rotor está fijado correctamente. Si el rotor o los accesorios entran en contacto con material infeccioso, se debe llevar a cabo una desinfección adecuada.

Substancias contenidas en desinfectantes adecuados incluye Etanol, n-propanol, etil - hexanol, agentes tensioactivos aniónicos, agentes tensioactivos no aniónicos. Después de utilizar desinfectantes, deben eliminarse los residuos lavando con agua (solo en el exterior de la centrífuga) o limpiando con un paño húmedo. El rotor y los accesorios se deben secar inmediatamente después de la desinfección.

Para eliminación de impurezas radioactivas el medio debe estar certificado de forma especial para la eliminación de impurezas radioactivas. Substancias contenidas en medios adecuados para la eliminación de impurezas radioactivas incluye agentes tensioactivos aniónicos, tensioactivos no iónicos, etanol polihidratado. Después de eliminar las impurezas radioactivas, se deben eliminar los residuos lavando con agua (solo en el exterior de la centrífuga) o limpiando con un paño húmedo. El rotor y los accesorios se deben secar inmediatamente después de eliminar las impurezas radioactivas.

El rotor puede tratarse en autoclave a 121 °C / 250 °F (20 min) y secado apropiadamente. El rotor debe cambiarse por razones de seguridad después de 10 tratamientos en autoclave. El tratamiento en autoclave acelera el proceso de envejecimiento de los plásticos. Además puede causar modificaciones de color en los plásticos. Después de tratarse en autoclave, esperar hasta que el rotor se enfríe a temperatura ambiente antes de volverlo a utilizar. No se puede dar ninguna información sobre el grado de esterilidad.

La duración del rotor está limitada en 50000 ciclos (ciclos de centrifugado) o 5 años, lo que ocurra primero. El número máximo admisible de ciclos de ejecución es visible en el rotor. Por razones de seguridad el rotor no puede utilizarse más cuando se alcanza el número máximo de ciclos especificado. El aparato está equipado con un contador que cuenta los ciclos de centrifugado.

En caso de fractura del tubo sanguíneo, todas las partes rotas y la sangre deben eliminarse por completo. La centrífuga se debe limpiar a fondo como se indica y se deben reemplazar los insertos de goma y los manguitos de plástico del rotor.

ARCHIVED DOCUMENT

12 DATOS TÉCNICOS DE CENTRIFUGADO

Tipo de modelo	IS220Z	IS110Z
Tensión de red ($\pm 10\%$)	200 - 240 V 1~	100 - 127 V 1~
Frecuencia de la red	50 - 60 Hz-	50 - 60 Hz
Potencia conectada	100 VA	100 VA
Consumo de corriente	0.5 A	1.0 A
Capacidad máx.	8 x 10 ml	
Densidad permitida	1.2 kg/dm ³	
Velocidad (RPM)	6,000	
Aceleración (RCF)	3,461	
Energía cinética	750 Nm	
Lugar de instalación	Sólo en interiores	
Altura	Hasta 2000 m encima del nivel del mar	
Temperatura ambiente para la operación	5°C hasta 40°C	
Humedad atmosférica para la operación	Humedad máxima relativa del aire del 80% para temperaturas hasta 31°C, linealmente decreciente hasta una humedad relativa del aire del 50% a 40°C.	
Categoría de sobretensión	II	
Grado de suciedad	2	
Clase de protección del aparato	I	
	No apropiada para el uso en entornos que presenten peligro de explosión.	
Emisión de interferencias, Resistencia a perturbaciones	EN / IEC 61326-1, Class B	FCC Class B
Nivel de ruido (en función del rotor)	≤ 50 dB(A)	
Ancho de la centrífuga	261 mm	
Profundidad de centrifugadora	353 mm	
Altura de centrifugadora	228 mm	
Peso de la centrífuga	approx. 9 kg	

13 INSTRUCCIONES DE FUNCIONAMIENTO DE LA CENTRIFUGA

Es imprescindible que se retire el dispositivo de sujeción del transporte, que consta de 2 tornillos (a) y 2 espaciadores (b). Mantenga el dispositivo de seguridad de transporte en un lugar seguro, ya que debe instalarse nuevamente antes de transportar el dispositivo. El dispositivo solo se puede transportar con el dispositivo de seguridad de transporte instalado. Para proteger el dispositivo de daños durante el transporte, el motor se fija en su lugar. Este dispositivo de seguridad de transporte debe retirarse cuando el dispositivo se pone en funcionamiento.

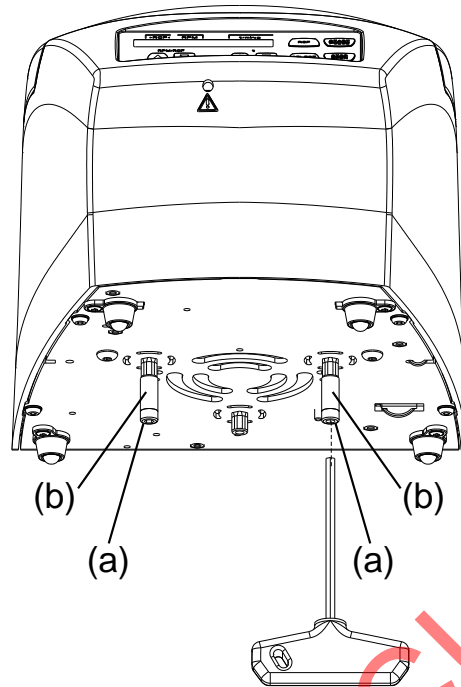

13.1 PUESTA EN MARCHA

- Retire el dispositivo de seguridad de transporte del lado inferior de la centrífuga.
- Coloque la centrífuga de manera estable y nivelada en un lugar adecuado. Cuando la centrífuga está funcionando, ninguna persona, sustancias u objetos peligrosos pueden estar dentro del margen de seguridad de 300 mm alrededor de la centrífuga.
- Las aberturas de ventilación no deben bloquearse. Se debe mantener una distancia de 300 mm desde las ranuras de ventilación y las aberturas de la centrífuga.
- Compruebe si la tensión de la red coincide con la declaración en la placa de características.
- Conecte la centrífuga con el cable de alimentación a una toma de corriente estándar.
- Encienda el interruptor de red.
- En el panel aparecen las siguientes pantallas: el tipo de modelo de centrífuga, la versión del software y los últimos datos de centrifugación utilizados.
- Si la tapa está cerrada, se muestra el mensaje "Abrir la tapa". En este caso, abra la tapa para mostrar los datos de centrifugación.

13.2 ABRIR Y CERRAR LA TAPA DE LA CENTRIFUGA

La tapa solamente se deja abrir cuando la centrífuga está conectada y el rotor se encuentra parado. Cuando se activa el contador de ciclos, después de una operación de centrifugación, al abrir la tapa, se muestra brevemente el número restante de ciclos de operación (operaciones de centrifugación).

Ejemplo:





Para abrir la tapa, presione la siguiente tecla . La tapa se desbloquea por motor.  indica tapa desbloqueada.



Ejemplo:

No toque con los dedos entre la tapa y la carcasa. No cierre de golpe la tapa.

Para cerrar la tapa, presione ligeramente el borde frontal de la tapa.  indica tapa cerrada.



Ejemplo:

13.3 DESBLOQUEO DE EMERGENCIA

En el caso de una falla de energía, la tapa no se puede desbloquear con el motor. El desbloqueo de emergencia debe hacerse a mano. Para desbloquear en una emergencia, apague el interruptor de red (ajuste del interruptor "0"). Mire a través de la ventana en la tapa para asegurarse de que el rotor esté parado. Abra la tapa solo cuando el rotor esté parado. Inserte la llave Allen horizontalmente en el orificio (A) y gire con cuidado en sentido antihorario (hacia la izquierda) hasta que se abra la tapa. ¡PRECAUCIÓN! Girar la llave Allen hexagonal en el sentido de las agujas del reloj (hacia la derecha) puede dañar el sistema de bloqueo. Tire de la llave Allen fuera del orificio.

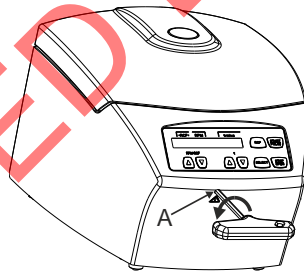

13.4 MONTAJE Y DESMONTAJE DE ROTOR

Para quitar el rotor, afloje la tuerca de sujeción del rotor girándola en sentido antihorario con la llave Allen (incluida en la entrega) y gire hacia el punto de presión de elevación. Después de superar el punto de presión de elevación, el rotor se libera del cono del eje del motor. Gire la tuerca de sujeción hasta que el rotor pueda levantarse del eje del motor. Levante el rotor del eje del motor.

Para instalar el rotor, limpie el eje del motor (A) y el orificio del rotor y aplique una fina capa de grasa al eje del motor. Las partículas de suciedad entre el eje del motor y el rotor evitan que el rotor tenga un asiento perfecto y hace que funcione de manera inestable. Coloque el rotor verticalmente sobre el eje del motor. Al colocar el rotor, la viga marcadora (B) en el rotor debe ser paralela a ambas superficies (C) en el eje del motor. Apriete la tuerca de sujeción del rotor con la llave Allen (incluida en la entrega) girándola en sentido horario. Verifique el rotor para asegurarse de que esté asentado firmemente.

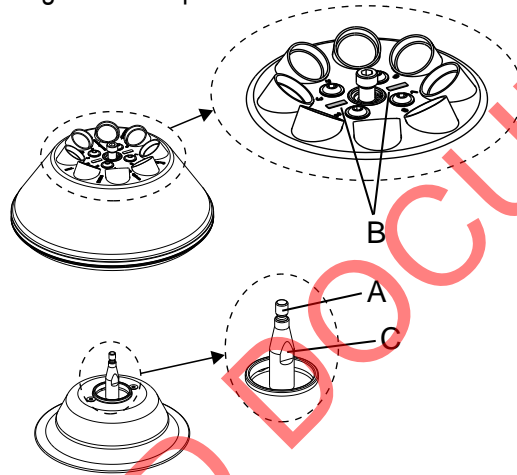

Los rotores sólo se deben cargar simétricamente. Los tubos de sangre deben distribuirse uniformemente en todas las posiciones del rotor.



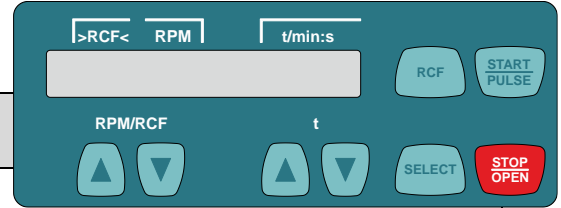

Los tubos de sangre solo pueden llenarse fuera de la centrifuga. La cantidad máxima de llenado para los tubos de sangre se especifica en los mismos tubos y no debe exceder el peso máximo indicado en el rotor. Los recipientes de centrifugación solo se pueden llenar hasta el punto de que no se pueda expulsar fluido mientras la centrifuga está funcionando. Al cargar el rotor, no puede entrar líquido al rotor ni a la cámara de centrifugación. Para mantener las diferencias de peso dentro del contenedor de centrifuga lo más marginal posible, se recomienda un nivel de llenado constante en los tubos de sangre.

13.5 DESCRIPCIÓN DE LOS ELEMENTOS DE LA PANTALLA



Símbolo / Tecla del panel	Descripción
	Tapa desbloqueada.
	Tapa bloqueada.
	Indicación de rotación. La pantalla de rotación se ilumina, girando en sentido horario, cuando el rotor está girando.
	Para ingresar velocidad directamente. Manteniendo pulsada la tecla el valor cambia con velocidad creciente.
	Para ingresar el tiempo de ejecución directamente. Ajustable hasta 1 minuto en pasos de 1 segundo y a partir de 1 minuto en pasos de 1 minuto. Para ingresar los parámetros de centrifugación. Manteniendo pulsada la tecla el valor cambia con velocidad creciente.
	Para activar parámetros individuales. Por cada nueva pulsación de la tecla se selecciona el parámetro siguiente. Mantenga presionada la tecla durante 8 segundos para activar el "MACHINE MENU". Seleccionar en "Machine Menu", los menús "->Info", "->Settings" and "Time & Cycles". Para avanzar en los menús.
	Para alternar entre la pantalla de velocidad (RPM) y la pantalla de fuerza centrífuga relativa (RCF). Los valores de RCF se muestran entre las flechas ><.
	Para comenzar la centrifugación. Para centrifugación a corto plazo. El ciclo de centrifugado se ejecuta mientras se mantenga pulsada la tecla. Para seleccionar los menús "->Info", "->Settings" and "->Time & Cycles".
	Para finalizar la centrifugación. El rotor marcha por inercia con el nivel de frenado preseleccionado. El pulsado doble de la tecla activa la parada de emergencia. Para desbloquear la tapa.
t/min	Tiempo de ejecución. Ajustable de 1 - 99 min. en pasos de 1 minuto.
t/sec	Tiempo de ejecución. Ajustable de 1 - 59 seg. en pasos de 1 segundo. Ciclo permanente "--:--". Ajustar en cero los parámetros t/min y t/sec.
RPM	Número de revoluciones. Ajustable es un valor numérico de 200 RPM hasta el número máximo de revoluciones del rotor. Ajustable en pasos de 10.
>RCF<	Aceleración centrífuga relativa. Ajustable es un valor numérico que suministra un número de revoluciones entre 200 RPM y el número máximo de revoluciones del rotor. Ajustable en pasos de 1. La entrada de la aceleración centrífuga relativa (RCF) solamente es posible cuando está seleccionada la indicación RCF (RCF). La aceleración centrífuga relativa (RCF) depende del radio de centrifugado (RAD). Después de la entrada del RCF controlar que esté ajustado correctamente el radio de centrifugado.
RAD/mm	Radio de centrifugado. Ajustable de 10 mm hasta 250 mm, en pasos de 1 milímetro. La entrada del radio de centrifugado solamente es posible cuando está seleccionada la indicación RCF (>RCF<).
~_DEC	Nivel de frenado. fast = tiempo de marcha en inercia breve, slow = tiempo de marcha en inercia prolongado.

13.6 ENTRADA DIRECTA DE LOS PARÁMETROS DE CENTRIFUGADO

El número e revoluciones (RPM), la aceleración centrífuga relativa (RCF), el radio de centrifugado (RAD) y el tiempo de ejecución puede introducirse directamente con las teclas   sin tener que pulsar antes la tecla . Los parámetros de centrifugado ajustados se guardan sólo después del inicio del ciclo de centrifugado.

Por Velocidad (RPM):

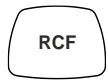

En caso de necesidad pulsar la tecla para seleccionar la indicación RPM (RPM).



Ajustar el valor deseado con las teclas.



Ejemplo:

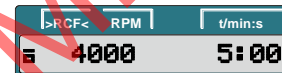

Para aceleración centrífuga relativa (RCF) y radio de centrifugado (RAD):

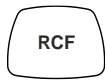

En caso de necesidad pulsar la tecla para seleccionar la indicación RDF (>RCF<)



Ajustar el valor RCF deseado con las teclas.

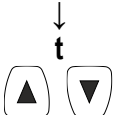

En caso de necesidad, ajustar con las teclas el radio de centrifugado deseado.

Ejemplo:

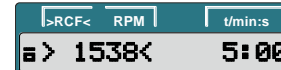
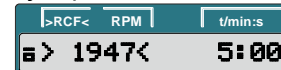

Tiempo de ejecución:

El tiempo de ejecución puede ajustarse hasta 1 minuto en pasos de 1 segundo y a partir de 1 minuto en pasos de 1 minuto. Colocar en cero los parámetros *t/min* y *t/sec* para ajustar el ciclo permanente. En la indicación de tiempo (*t/min:s*) aparece "--:--".

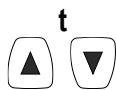

Ajustar el valor deseado con las teclas.

Ejemplo:



13.7 ENTRADA DE LOS PARÁMETROS DE CENTRIFUGADO CON LA TECLA "SELECT"

El tiempo de ejecución puede ajustarse en minutos y segundos (parámetros **t/min** y **t/sec**).

Colocar en cero los parámetros **t/min** y **t/sec** para ajustar el ciclo permanente. En la indicación de tiempo (t/min:s) aparece "--:--".



Ejemplo:

La aceleración centrífuga relativa (RCF) depende del radio de centrifugado (RAD). Durante la entrada del RCF se visualiza el radio de centrifugado ajustado. Si después de la selección o durante la entrada de parámetros no se pulsa ninguna tecla durante 8 segundos, se muestran en la indicación de nuevo los valores anteriores. Los parámetros deben ingresarse nuevamente. Pulsando la Tecla **START PULSE** se guardan los ajustes.

En la entrada de varios parámetros debe pulsarse la tecla **START PULSE** sólo después del ajuste del último parámetro. La entrada de los parámetros se puede interrumpir en cualquier momento, pulsando la tecla

STOP OPEN. En este caso no se guardan los ajustes.

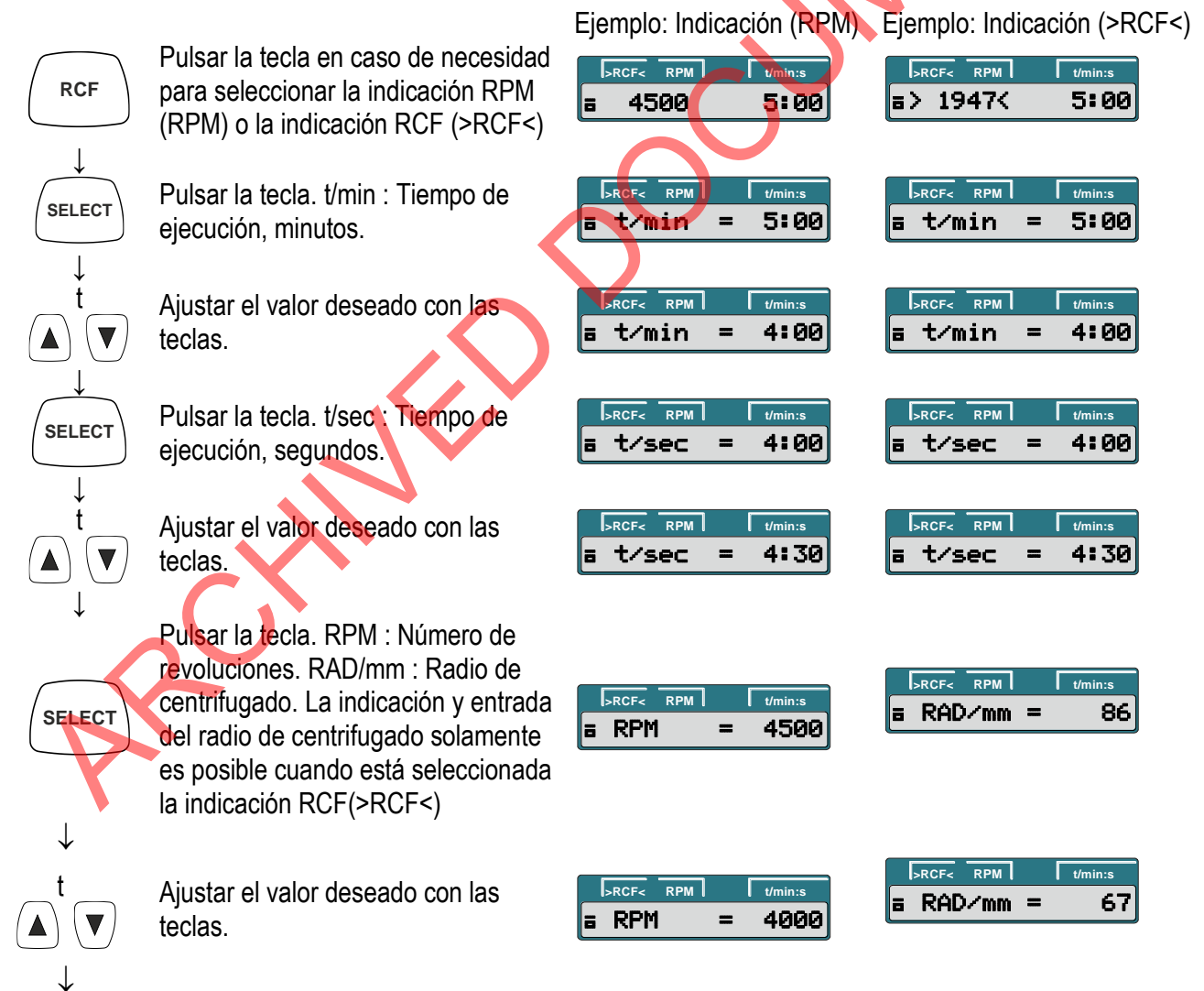

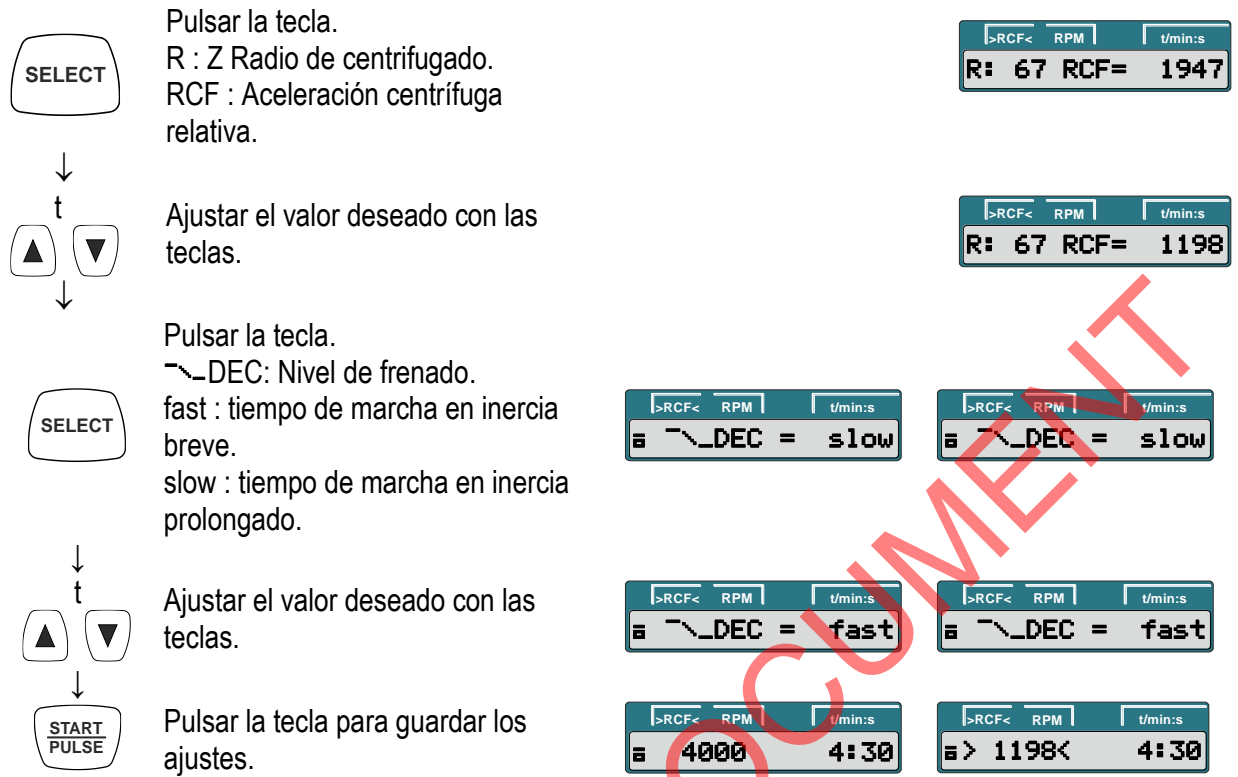

13.8 PANTALLA DEL PANEL DE CONTROL

Después de cada ciclo de centrifugado, durante el desbloqueo de la tapa, se indica brevemente el número de ciclos de ejecución restantes (ciclos de centrifugado).

Ejemplo:

Si se excede la diferencia admisible de peso dentro de la carga del rotor, el ciclo de centrifugado se interrumpe durante el arranque y se mostrará "IMBALANCE".

Ejemplo:

Un ciclo de centrifugado puede interrumpirse en cualquier momento pulsando la tecla . Durante un ciclo de centrifugado pueden seleccionarse y modificarse parámetros de centrifugado. Sin embargo los valores modificados son válidos solamente para el ciclo de centrifugado actual y no se guardan. Con la tecla

puede cambiarse en cualquier momento entre la indicación RPM (RPM) y la indicación RCF (>RCF<). Si se modifica la pantalla RCF (>RCF<), se debe ingresar el radio de centrifugación. Así es posible continuar el manejo de la centrífuga solo después de abrir la tapa. Se visualizan errores de manejo y fallos.

Ejemplo:

13.9 CENTRIFUGADO CON PRESELECCIÓN DE TIEMPO

RCF Pulsar la tecla en caso de necesidad para seleccionar la indicación RPM (RPM) o la indicación RCF (>RCF<).

Introducir los parámetros de centrifugado deseados.

START PULSE Pulsar la tecla para iniciar el ciclo de centrifugado. Durante el ciclo de centrifugado se indica el número de revoluciones del rotor o el valor RCF resultante y el tiempo residual.

Después de transcurrir el tiempo o en caso de interrupción del ciclo de centrifugado, pulsando la tecla **STOP OPEN** tiene lugar la marcha en inercia con el nivel de frenado ajustada. Se indica el nivel de frenado \sim f.

Ejemplo: Indicación (RPM)

>RCF<	RPM	t/min:s
4500	5:00	

>RCF<	RPM	t/min:s
4000	4:30	

>RCF<	RPM	t/min:s
4000	3:15	

>RCF<	RPM	t/min:s
3980	\sim f	

Ejemplo: Indicación (>RCF<)

>RCF<	RPM	t/min:s
> 1947<	5:00	

>RCF<	RPM	t/min:s
> 1538<	4:30	

>RCF<	RPM	t/min:s
> 1538<	3:15	

>RCF<	RPM	t/min:s
> 1523<	\sim f	

13.10 CICLO PERMANENTE

RCF Pulsar la tecla en caso de necesidad para seleccionar la indicación RPM (RPM) o la indicación RCF (>RCF<).

Introducir los parámetros de centrifugado deseados. Ajustar en cero los parámetros t/min y t/sec.

START PULSE Pulsar la tecla para iniciar el ciclo de centrifugado. Durante el ciclo de centrifugado se indica el número de revoluciones del rotor o el valor RCF resultante y el tiempo transcurrido.

STOP OPEN Pulsar la tecla para terminar el ciclo de centrifugado. La marcha en inercia se realiza con el nivel de frenado ajustado. Se indica el nivel de frenado \sim f.

Ejemplo: Indicación (RPM)

>RCF<	RPM	t/min:s
4500	5:00	

>RCF<	RPM	t/min:s
4000	--:--	

>RCF<	RPM	t/min:s
4000	2:45	

>RCF<	RPM	t/min:s
3980	\sim f	

Ejemplo: Indicación (>RCF<)

>RCF<	RPM	t/min:s
> 1947<	5:00	

>RCF<	RPM	t/min:s
> 1538<	--:--	

>RCF<	RPM	t/min:s
> 1538<	2:45	

>RCF<	RPM	t/min:s
> 1523<	\sim f	

13.11 CENTRIFUGADO DE CORTA DURACIÓN



Pulsar la tecla en caso de necesidad para seleccionar la indicación RPM (RPM) o la indicación RCF (>RCF<).

Introducir los parámetros de centrifugado deseados.



Mantener pulsada la tecla. Durante el ciclo de centrifugado se indica el número de revoluciones del rotor o el valor RCF resultante y el tiempo transcurrido.



Volver a soltar la tecla para terminar el ciclo de centrifugado. La marcha en inercia se realiza con el nivel de frenado ajustado. Se indica el nivel de frenado ~f.

Ejemplo: Indicación (RPM)



Ejemplo: Indicación (>RCF<)



13.12 PARADA DE EMERGENCIA



Pulsar la tecla dos veces. En caso de Parada de Emergencia la marcha en inercia tiene lugar con el nivel de frenado "fast" (tiempo de marcha en inercia breve). Se visualiza el nivel de frenado ~f.

Ejemplo: Indicación (RPM)



Ejemplo: Indicación (>RCF<)



13.13 CONTADOR DE CICLOS

La centrífuga está equipada con un contador que cuenta los ciclos (ciclos de centrifugado). Después de cada ciclo de centrifugado, durante el desbloqueo de la tapa, se indica brevemente el número de ciclos de ejecución restantes (ciclos de centrifugado).

Ejemplo:

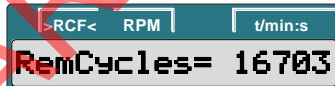

Si se ha excedido el número máximo admisible de ciclos de ejecución del rotor, aparece la siguiente indicación después de cada inicio de un ciclo de centrifugado. La operación de centrifugación debe reiniciarse. Por razones de seguridad el rotor debe cambiarse de inmediato por uno nuevo. Después de cambiar el rotor, el contador de ciclos debe reposicionarse en "0".

Ejemplo:



13.14 RESTABLECER EL CONTADOR DE CICLO A CERO

Después de cambiar el rotor, el contador de ciclos debe reposicionarse de nuevo en cero. El contador de ciclos puede reposicionarse en cero solamente cuando se cambió el rotor por uno nuevo. El contador de ciclos puede reposicionarse con el rotor en reposo como se muestra a continuación. La operación puede interrumpirse en cualquier momento pulsando la tecla . En este caso no se guardan los ajustes.

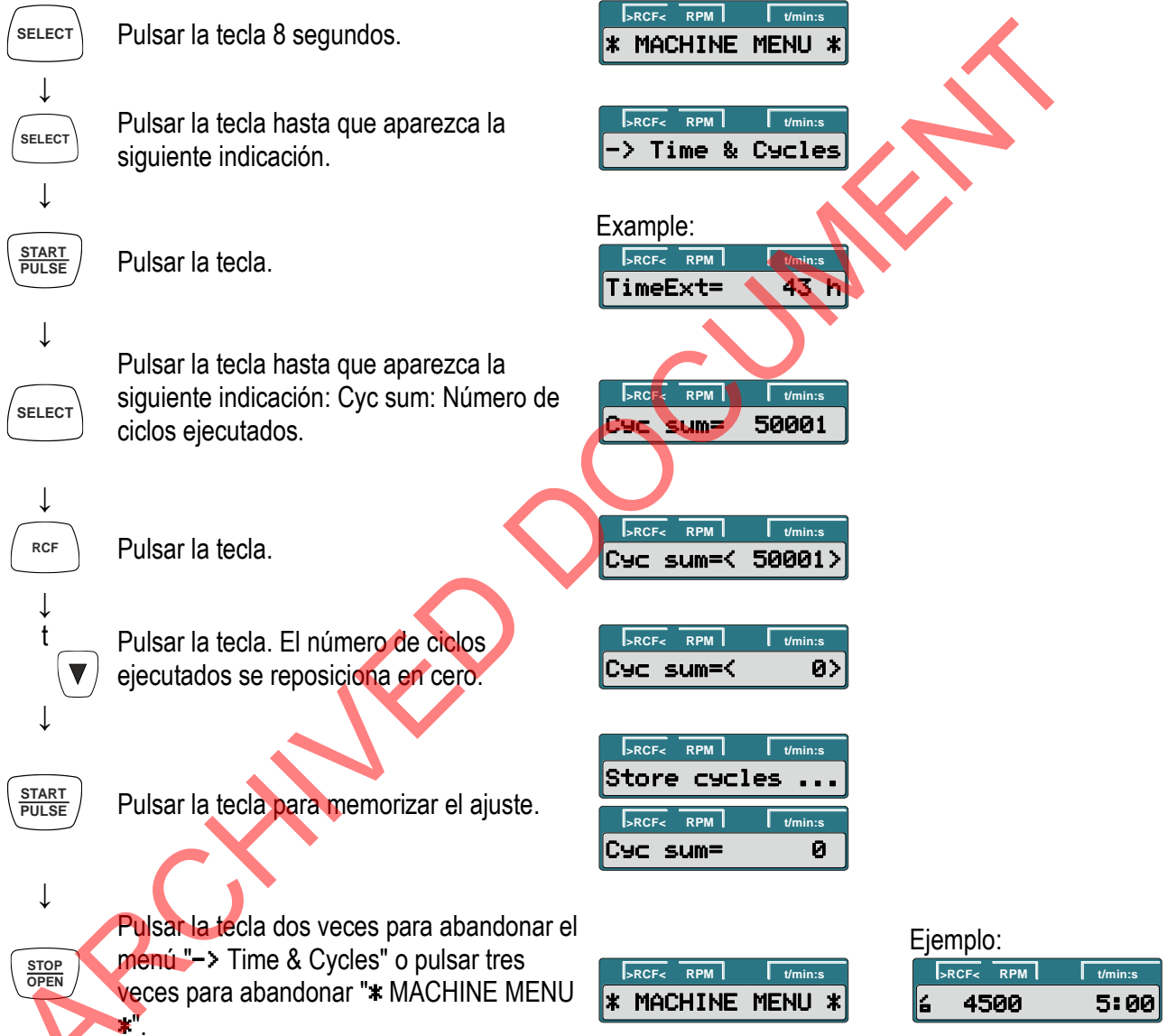

13.15 SETTINGS AND QUERIES

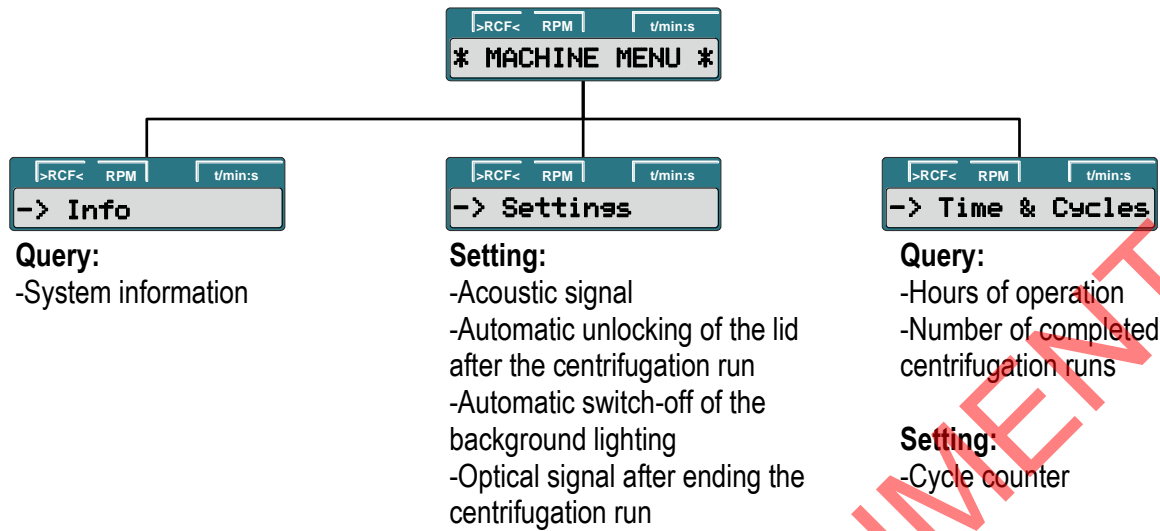

13.16 CONSULTAR LAS INFORMACIONES DEL SISTEMA

Pueden consultarse las siguientes informaciones del sistema:

- Modelo de aparato
- Versión del programa del aparato
- Número de tipo del aparato
- Fecha de fabricación del aparato
- Número de serie del aparato
- Tipo del convertidor de frecuencia
- Versión del programa del convertidor de frecuencia

Con el rotor en reposo la consulta puede realizarse como sigue: La operación puede interrumpirse en cualquier momento pulsando la tecla .

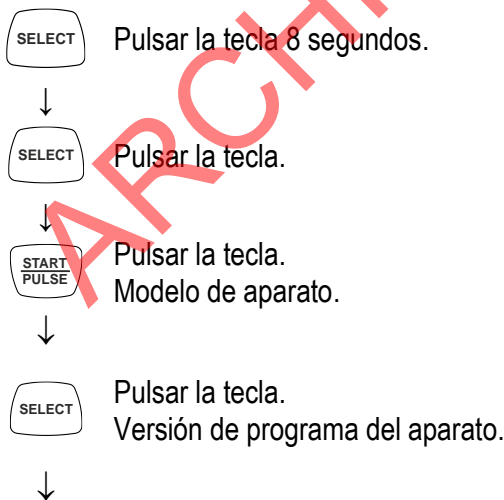

Ejemplo:

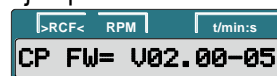



Pulsar la tecla.
Type#1: Número de tipo del aparato.

Ejemplo:



Pulsar la tecla.
Type#2: Continuación del Número de tipo, cuando este tiene más posiciones que el campo de visualización "Type#1".

Ejemplo:

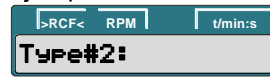

Pulsar la tecla.
 Fecha de fabricación del aparato.

Ejemplo:

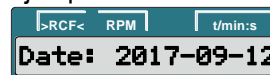

Pulsar la tecla.
 Número de serie del aparato.

Ejemplo:



Pulsar la tecla.
 Tipo del convertidor de frecuencia.

Ejemplo:



Pulsar la tecla.
 Versión de programa del convertidor de frecuencia.

Ejemplo:



Pulsar la tecla dos veces para abandonar el menú "-> Info" o pulsar tres veces para abandonar "* MACHINE MENU *".



Ejemplo:

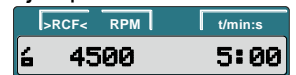

13.17 SEÑAL ACÚSTICA

La señal acústica suena (1) después de presentarse un fallo en un intervalo de 2 seg y (2) después de terminar el ciclo de centrifugado y la parada del rotor en un intervalo de 30 seg. Pulsando una tecla cualquiera termina la señal acústica. Con el rotor en reposo la señal acústica puede ajustarse como sigue.

La operación puede interrumpirse en cualquier momento pulsando la tecla . En este caso no se guardan los ajustes.



Pulsar la tecla 8 segundos.



Pulsar la tecla hasta que aparezca la siguiente indicación.





Pulsar la tecla.
End beep: Señal acústica después de la terminación del ciclo de centrifugado.
off: Señal desactiva.
on: Señal activa.

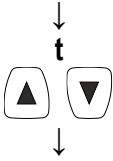

Ajustar **off** (Desc.) u **on** (Con.) con las teclas.



Pulsar la tecla.
Error beep: Señal acústica después de presentarse un fallo.
off: Señal desactiva.
on: Señal activa.

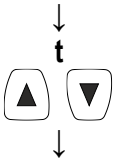

Ajustar **off** (Desc.) u **on** (Con.) con las teclas.



Pulsar la tecla.
Beep volume: Volumen de la señal acústica.
min: suave
mid: medio
max: intensa

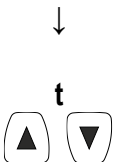

Ajustar **mín**, **mid**, o **máx** con las teclas.



Pulsar la tecla para memorizar el ajuste.



Pulsar la tecla una vez para abandonar el menú "-> Settings" o pulsar dos veces para abandonar "* MACHINE MENU *".



Example:



13.18 SEÑAL ÓPTICA DESPUÉS DE LA TERMINACION DEL CICLO DE CENTRIFUGADO

La iluminación de fondo de la indicación parpadea después del ciclo de centrifugado, para indicar ópticamente que ha terminado el ciclo de centrifugado. Con el rotor en reposo la señal óptica puede activarse o desactivarse como sigue.

La operación puede interrumpirse en cualquier momento pulsando la tecla .

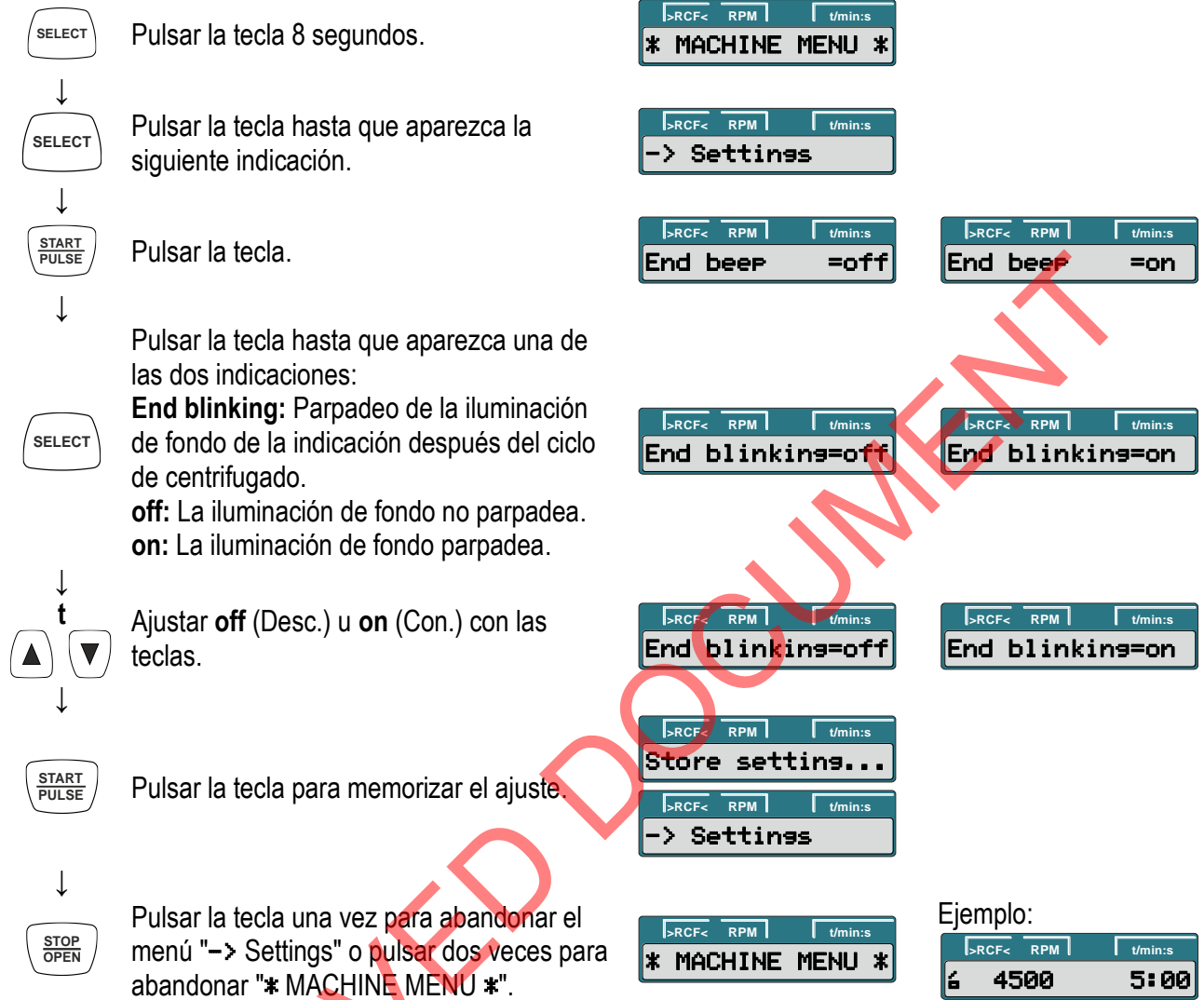

13.19 DESBLOQUEO AUTOMÁTICO DE LA TAPA DESPUÉS DEL CICLO DE CENTRIFUGADO

Puede ajustarse si después del ciclo de centrifugado la tapa se desbloquea automáticamente o no. Con el rotor en reposo esto puede ajustarse como sigue. La operación puede interrumpirse en cualquier momento pulsando la tecla . En este caso no se guardan los ajustes.

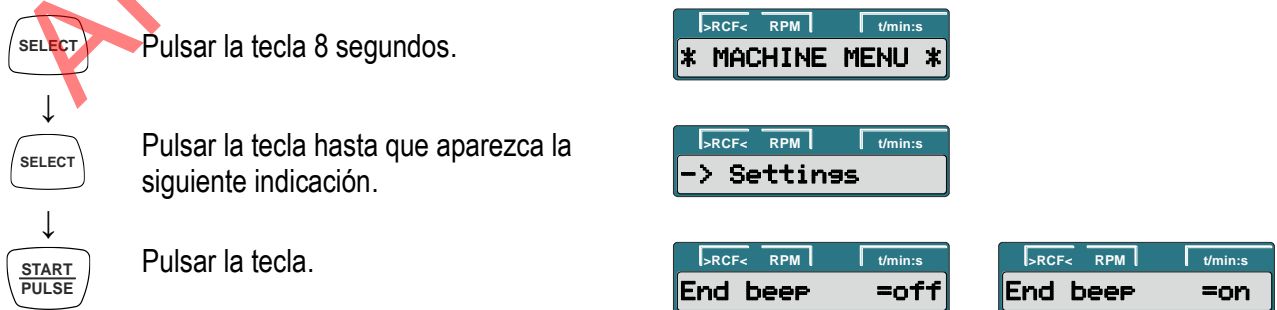

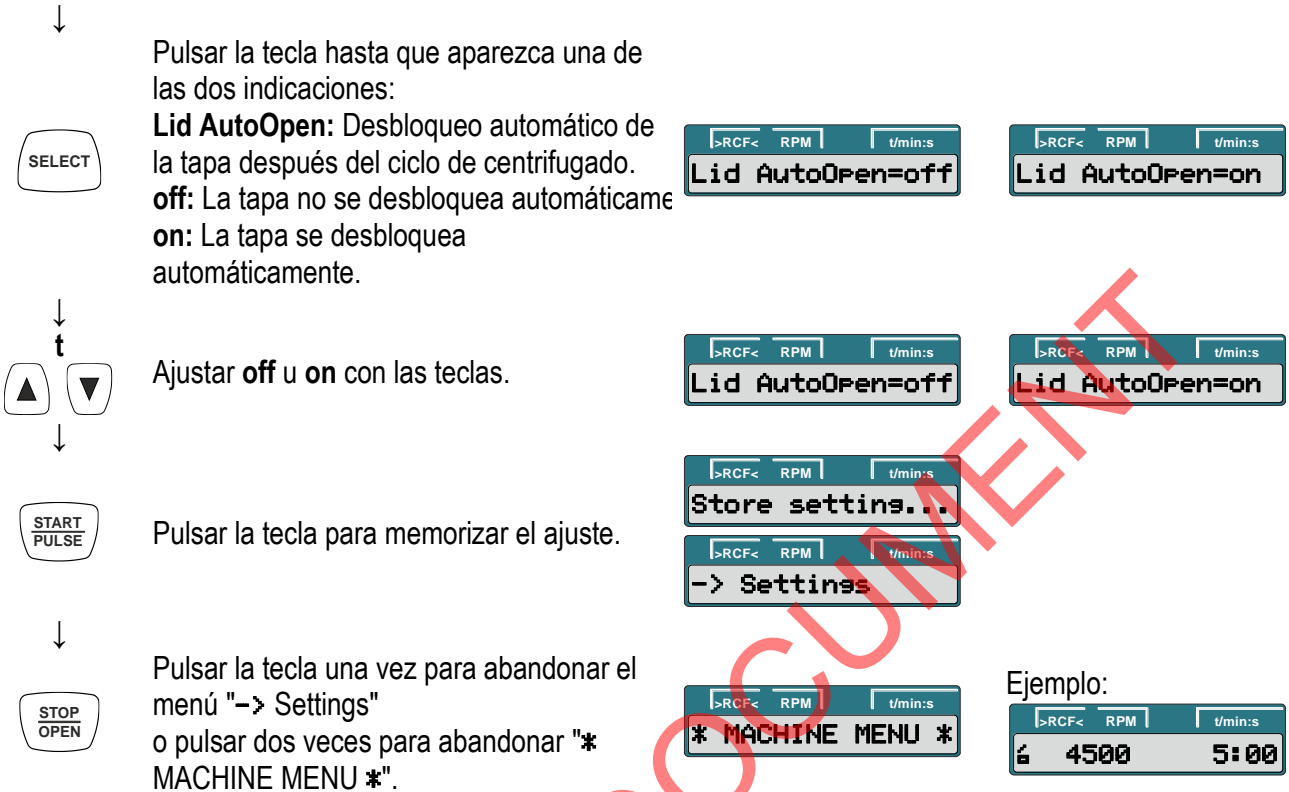

13.20 ILUMINACIÓN DE FONDO DE LA INDICACIÓN

Para ahorrar energía puede ajustarse que después de un ciclo de centrifugado la iluminación de fondo de la indicación se apague después de 2 minutos. Con el rotor en reposo ésto puede ajustarse como sigue. La operación puede interrumpirse en cualquier momento pulsando la tecla **STOP OPEN**. En este caso no se guardan los ajustes.

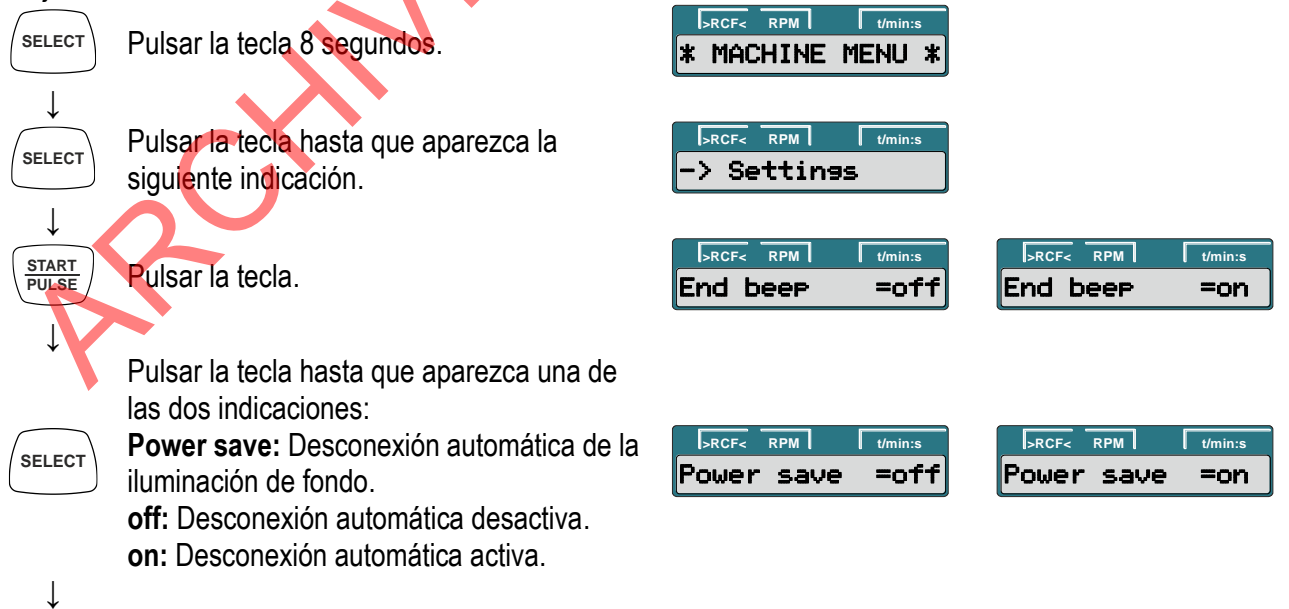

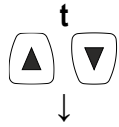

Ajustar **off** (Desc.) u **on** (Con.) con las teclas.



Pulsar la tecla para memorizar el ajuste..

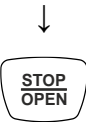

Pulsar la tecla una vez para abandonar el menú "-> Settings" o pulsar dos veces para abandonar "* MACHINE MENU *".



13.21 CONSULTAR LAS HORAS DE SERVICIO Y EL NÚMERO DE CICLOS DE CENTRIFUGADO

Las horas de servicio se distribuyen en horas de servicio internas y externas. Horas de servicio internas: tiempo total que estuvo conectado el aparato. Horas de servicio externas: Tiempo total de los ciclos de centrifugado ejecutados. Con el rotor en reposo la consulta puede realizarse como sigue. La operación puede interrumpirse en cualquier momento pulsando la tecla .



Pulsar la tecla 8 segundos.

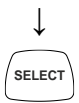

Pulsar la tecla hasta que aparezca la siguiente indicación.



Pulsar la tecla.
TimeExt: Horas de servicio externas.

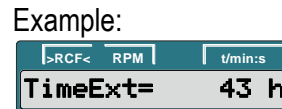

Pulsar la tecla.
TimeInt: Horas de servicio internas.

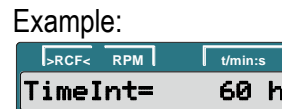

Pulsar la tecla.
Starts: Número de todos los ciclos de centrifugado.

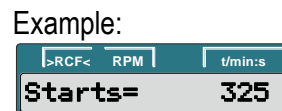

Pulsar la tecla dos veces para abandonar el menú "-> Time & Cycles" o pulsar tres veces para abandonar "* MACHINE MENU *".





14 ERRORES

Si no se puede eliminar el fallo según la tabla de fallos, se debe informar al servicio al cliente y indicar el tipo de centrifuga y el número de serie. Ambos números son visibles en la placa indicadora de tipo de la centrifuga.



Realizar un RESET-RED: Apagar el interruptor de red (posición de interruptor "0"). Esperar al menos 10 segundos y a continuación volver a encender el interruptor de red (posición de interruptor "I").

Indicación / avería		Motivo	Solución
Sin pantalla		Sin tensión Fusibles de la entrada de red defectuosos.	<ul style="list-style-type: none"> – Comprobar la tensión de suministro. – Comprobar los fusibles de la entrada de la red y consulte las instrucciones para cambiar el fusible de red. – Conmutador de red ENCENDIDO.
IMBALANCE		El rotor se ha cargado de manera irregular.	<ul style="list-style-type: none"> – Abrir la tapa después de que el rotor se detenga. – Comprobar la carga del rotor. – Repetir el ciclo de centrifugación.
MAINS INTER	11	Interrupción de la red durante el ciclo de centrifugación. (El ciclo de centrifugación no se terminó.)	<ul style="list-style-type: none"> – Abrir la tapa después de que el rotor se detenga. – Pulsar la tecla start/pause. – En caso de necesidad, repetir el ciclo de centrifugación.
MAINS INTERRUPT			
TACHO ERROR	1, 2	Caída del impulso de número de revoluciones durante el funcionamiento.	<ul style="list-style-type: none"> – Después de la parada del rotor, ejecutar el RESET RED.
LID ERROR	4.1 – 4.127	Fallo del bloqueo o del enclavamiento de la tapa.	
OVER SPEED	5	Revoluciones excesivas	
VERSION ERROR	12	Se reconoció un modelo incorrecto de centrifuga. Fallo / defecto sistema electrónico	<ul style="list-style-type: none"> – Después de la parada del rotor, ejecutar el RESET RED.
UNDER SPEED	13	Revoluciones por debajo de las mínimas	
CTRL ERROR	22.1, 25.2	Fallo / defecto sistema electrónico.	
CRC ERROR	27.1		
COM ERROR	31 – 36		
FC ERROR	60, 61.1 – 61.21, 61.64 – 61.142		
FC ERROR	61.23		<ul style="list-style-type: none"> – El aparato no puede desconectarse mientras la indicación de rotación  esté iluminada. Esperar hasta que se visualice el símbolo  (Tapa bloqueada) después de aprox. 120 segundos). A continuación realizar un RESET RED.
TACHO ERR	61.22	Error - Medición del número de revoluciones	
FC ERROR	61.153	Fallo / defecto sistema electrónico	<ul style="list-style-type: none"> – Ejecutar un RESET RED. – Comprobar la carga del rotor por las instrucciones proporcionadas. – Repetir el ciclo de centrifugación.

15 ACCELERACION CENTRIFUGA RELATIVA (RCF)

La aceleración centrífuga (RCF) relativa se indica como múltiple de la aceleración terrestre (g). Es un valor numérico no unitario y sirve para la comparación de los rendimientos de separación y de sedimentación.

La aceleración centrífuga relativa (RCF) depende de la cantidad de giros y del radio centrifugado. Se puede calcular utilizando la siguiente fórmula:

$$RCF = \left(\frac{RPM}{1000} \right)^2 \times r \times 1,118 \quad \Rightarrow \quad RPM = \sqrt{\frac{RCF}{r \times 1,118}} \times 1000$$

RCF = aceleración centrífuga relativa

RPM = cantidad de giros (revoluciones por minuto)

r = centrifugal radius in mm = distance from the centre of the turning axis to the bottom of the centrifuge container.

16 TRANSPORTE Y ALMACENAMIENTO

Antes del transporte del aparato debe montarse el dispositivo protector de transporte. El aparato y los accesorios deben ser almacenados solamente en lugares cerrados y secos. Durante el transporte y el almacenamiento del aparato deben cumplirse las siguientes condiciones ambientales:

Límites de temperatura: -20°C to +60°C.

Límites de humedad relativa del aire: 10% to 80%, sin condensación.

17 CAMBIAR LOS FUSIBLES DE LA ENTRADA DE RED

Comience apagando el interruptor de red y separar el aparato de la red. El portafusibles (A) junto con los fusibles de la entrada de red se encuentran al lado del interruptor de red. Sacar el cable de conexión del enchufe del aparato. Apretar el cierre de resorte (B) contra el portafusibles (A) y extraer éste. Reemplazar los fusibles de alimentación defectuosos. Utilizar solamente fusibles con el valor nominal especificado para el tipo de centrifuga proporcionada por el fabricante. Volver a introducir el portafusibles hasta que el cierre de resorte encaje. Volver a conectar el aparato a la red.

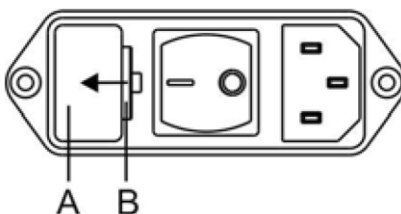

18 DEVOLUCIÓN DE APARATOS

Antes de la devolución del aparato se tiene que instalar el la protección de transporte. En caso de devolución del aparato o sus accesorios al fabricante legal, éste se deberá descontaminar y limpiar antes de la expedición para la protección de las personas, del medio ambiente y del material. El fabricante legal se reserva el derecho de denegar la recepción de aparatos o accesorios contaminados. Los costos en los que se incurran por concepto de medidas de limpieza y descontaminación será facturados al cliente.

19 ELIMINACIÓN

Antes de ser desechado, el aparato debe descontaminarse y limpiarse para la protección de las personas y el medio ambiente. Para la eliminación del dispositivo se deberán observar las prescripciones legales vigentes en cada caso. Según la Directiva 2002/96/CE (WEEE), los aparatos entregados después del 13.08.2005 ya no se deben eliminar con los residuos domésticos. El aparato pertenece al grupo 8 (aparatos médicos) y está clasificado en el ámbito Business-to-Business. Con el símbolo del cubo de basura tachado se indica que el aparato no se debe eliminar con los residuos domésticos.

Las normas de eliminación en los distintos países de la UE pueden variar. En caso de necesidad, consulte a su proveedor.

ARCHIVED DOCUMENT



Таблица символов ниже только для справки. Обратитесь к этикетке упаковки продукта для соответствующих символов.

условное обозначение	описание символа
	ОСТОРОЖНО!
	Электронные инструкции по эксплуатации
	Производитель
	Продукция компании BioHorizons имеет знак соответствия техническим регламентам ЕС и соответствует требованиям директивы 93/42/ЕЕС по медицинским приборам
	Источник / артикул
	Номер партии/серии
	Не использовать повторно
	Не стерилизуйте повторно.
	Срок годности
	Стерилизовано гамма-излучением
	Дата изготовления
Rx Only	Внимание! Федеральное законодательство США разрешает продажу, распространение и использование данных устройств только стоматологом или врачом или по их заказу

условное обозначение	описание символа
	исходное положение
	Не использовать, если упаковка повреждена
	Медицинское изделие
	Не стерильно
	Держать сухим
	Хрупкий; Обращаться осторожно
	Пределы температуры
	Эта сторона вверх
	Пределы влажности
	Предупреждение; Биологическая опасность
	Важные заметки
	Раздельный сборник электрических и электронных приборов.
	Уполномоченный представитель ЕС

1 ПОКАЗАНИЯ ДЛЯ ИСПОЛЬЗОВАНИЯ

Система IntraSpin предназначена для безопасной и быстрой подготовки аутологичного фибрина, обогащенного тромбоцитами, из небольшого образца крови на месте предоставления медицинских услуг. Фибрин, обогащенный тромбоцитами, смешивается с автотрансплантатом и/или аллогенной костью перед применением к костному дефекту для улучшения характеристик управления. Соблюдение всей информации в Инструкции по применению также является частью предполагаемого использования.

2 ПРОТИВОПОКАЗАНИЯ

Центрифуга IntraSpin предназначена только для целей, указанных в предполагаемом использовании устройства. Любое другое использование устройства считается нецелевым. Использование центрифуги IntraSpin противопоказано при наличии одной или нескольких из следующих клинических ситуаций: Пациенты с алкогольной зависимостью или психическими расстройствами, дискразиями крови, неконтролируемым диабетом, гипертиреозом, оральными инфекциями, злокачественными новообразованиями или пациентами, перенесшими инфаркт миокарда в течение последних 12 месяцев. Пациенты с системными заболеваниями, которые нарушают работу иммунной системы, такие как СПИД, пациенты, принимающие лекарства, которые могут повлиять на заживление места имплантации, пациенты с плохой историей или несоблюдением процедур гигиены полости рта.

Пациенты, которые принимают участие в антикоагулянтной терапии. Эти пациенты не исключены из преимуществ PRF, вместо этого пункт обслуживания должен добавить дополнительное время к центрифуге, чтобы разделение было эффективным для использования.



3 ПРИМЕЧАНИЯ ПО БЕЗОПАСНОСТИ

- Заявка по гарантии не будет рассмотрена производителем, если не будут соблюдаться ВСЕ инструкции в данном руководстве.
- Инструкция по эксплуатации является частью устройства. Они всегда должны быть доступны. Если устройство установлено в другом месте, вместе с ним должно быть предоставлено руководство по эксплуатации.
- Центрифуга должна быть установлена на хорошей устойчивой основе.
- Перед использованием центрифуги обязательно проверьте надежность установки ротора.
- Во время работы центрифуги в соответствии с EN/IEC 61010-2-020 люди, опасные вещества или предметы не должны находиться на расстоянии ближе 300 мм к центрифуге.
- Роторы, подвески и аксессуары, имеющие следы коррозии, механических повреждений или истекший срок эксплуатации, больше не могут использоваться.
- Центрифугу запрещено эксплуатировать, если камера центрифугирования имеет повреждения, влияющие на безопасность.
- У центрифуг без контроля температуры, если комнатная температура повышается и (или) если устройство часто используется, камера центрифугирования может нагреваться. Поэтому нельзя исключать возможность изменения материала образца под воздействием температуры.
- Перед началом эксплуатации центрифуги необходимо прочитать и учитывать положения инструкции по эксплуатации. Только персонал, который прочитал и понял инструкцию по эксплуатации, может работать с устройством.
- Наряду с инструкциями по эксплуатации и правовыми нормами по предотвращению несчастных случаев, вы также должны соблюдать принятые профессиональные правила для

обеспечения безопасной и профессиональной работы. Положения данной инструкции по эксплуатации должны быть согласованы с любыми другими инструкциями, касающимися предотвращения несчастных случаев и защиты окружающей среды, которые соответствуют национальным нормативным актам той страны, в которой эксплуатируется устройство.

- Ответственность за соблюдение требований конкретной страны в отношении охраны труда при использовании центрифуг на рабочих местах, предоставленных для этой цели пользователем, лежит на пользователе.
- Эта центрифуга является современным оборудованием, которое чрезвычайно безопасно в эксплуатации. Однако эксплуатация устройства может быть опасной для пользователей или других лиц, если оно будет использоваться неподготовленным персоналом, ненадлежащим образом или для целей, отличных от тех, для которых оно предназначено.
- Во время работы центрифугу нельзя перемещать и по ней нельзя стучать.
- В случае неисправности или аварийного сброса нельзя прикасаться к ротору, пока он не перестанет вращаться.
- Чтобы избежать повреждения конденсатом, при перемещении из холодного в теплое помещение центрифуга должна нагреваться в течение не менее 3 часов в теплом помещении перед подключением к электросети, или она должна нагреться при работе в течение 30 минут в холодном помещении.
- При центрифугировании с максимальной скоростью (об/мин) плотность материалов или смесей материалов не должна превышать 1,2 кг/дм³.
- Центрифуга может работать только при приемлемом балансе.
- Центрифуга не должна эксплуатироваться во взрывоопасных зонах.
- Центрифуга не должна использоваться со следующими материалами: горючие или взрывоопасные материалы; материалы, вступающие в реакцию друг с другом с выделением большого количества энергии.
- Для этой центрифуги нет систем биобезопасности.
- В центрифуге нельзя использовать коррозионно-активные вещества, которые могут нарушить механическую целостность роторов, подвесок и принадлежностей.
- Ремонт должен выполняться только персоналом, уполномоченным на такую работу производителем.
- С целью обеспечения самого высокого уровня клинической безопасности пациентов изделия Intra-Lock изготавливаются из материалов, которые являются биологически совместимыми с человеческой плазмой.
- Продажа данного продукта осуществляется на ограниченных рынках, он может быть недоступен для продажи на вашем рынке. Для получения дополнительной информации обратитесь к местному представителю компании.

4 КОМПОНЕНТЫ СИСТЕМЫ INTRASPIN

КОМПОНЕНТ	КОЛИЧЕСТВО НА СИСТЕМУ
Центрифуга IntraSpin в том числе:	1
Силовой кабель	1
взрыватель	2
Шестигранный ручной ключ	1
Пробирки для забора крови и балансировочные пробирки Greiner (для однократного использования).	150
Набор для сбора крови Greiner Safety + держатель, 21G (одноразовое использование)	24
Латексная бесплатная жгут	1
Штатив для пробирок	1
Хирургические изогнутые ножницы	1
Хирургические щипцы	1
Круглая чаша из нержавеющей стали	1
Прямоугольная чаша из нержавеющей стали	1
Двойной шпатель из биоматериала	1
Двойной упаковщик биоматериала	1
Блок Xpression	1

Только проверенные совместимые компоненты для прямого использования с центрифугой IntraSpin рекомендуются и гарантируются::

СОВМЕСТИМАЯ ЧАСТЬ #	ОПИСАНИЕ
455092	Tube 9ml Serum Clot CAT активатор, красная шапочка
455001	Белая крышка 9 мл Z Без добавок
VNEXZ (E613)	Шестигранный ключ IntraSpin, 110 В и 220 В
BROTORZ (E3694)	IntraSpin Потоп, 100 В и 220 В
BPOWER110Z (E1673)	Шнур питания IntraSpin, 110 В
BPOWER220Z (E1669)	Шнур питания IntraSpin, 220В
BTUBEHOLDZ (E872 x 1)	Замена держателя трубки IntraSpin
BFUSE110Z (E997)	IntraSpin Предохранитель 110v
BFUSE220Z (E891)	IntraSpin Предохранитель 220v

5 КРАТКАЯ УСТАНОВКА ЦЕНТРОБЕЖА

Снимите и сохраните транспортировочные болты с нижней части центрифуги.

Подсоедините кабель переменного тока и подключите к электрической розетке.

Включите центрифугу с помощью клавишного переключателя на задней панели устройства.

Выберите скорость и время: Скорость = 2700 & Время = 12:00 мин.

Нажмите START (ПУСК).

Крышка центрифуги открывается автоматически в конце каждого цикла.

После первой процедуры время и скорость фиксируются в памяти центрифуги, если настройки не изменены.

6 ПРЕДОСТЕРЕЖЕНИЯ И ИНСТРУКЦИИ ПО ИСПОЛЬЗОВАНИЮ ПРОБИРОК ДЛЯ ЗАБОРА КРОВИ И НАБОРОВ ДЛЯ ЗАБОРА КРОВИ

- Не используйте пробирки при наличии посторонних материалов.
- Необходимо полностью заполнять пробирки для забора крови.
- Обращайтесь со всеми биологическими образцами и острыми предметами для забора крови (например, иглами и наборами для забора крови) в соответствии с правилами и процедурами вашего учреждения.
- Не сгибайте иглу.
- Не высвобождайте с усилием и не активируйте предохранительный механизм иглы повторно после активации.
- Получите соответствующую медицинскую помощь в случае любого воздействия биологических образцов (например, из-за прокола) из-за возможной передачи ВИЧ (СПИД), вирусного гепатита или других инфекционных заболеваний.
- Откажитесь от всех "острых предметов" сбора крови в утвержденных контейнерах биологической опасности.
- Перенос образца из шприца в пробирку не рекомендуется.
- Если кровь собирается через внутривенную линию (IV), следуйте правилам и процедурам вашего учреждения, чтобы убедиться, что линия очищена от раствора IV до начала заполнения пробирок для забора крови.
- Ускоритель свертывания крови может выглядеть белым на поверхности трубки, что не влияет на производительность трубки. Если в пробирке присутствуют какие-либо другие изменения цвета или осадки, их не следует использовать.
- Не используйте пробирки после истечения срока годности.
- Храните пробирки для забора крови при температуре 4–25 °C (40–77 °F).
- Храните набор для забора крови (иглу и держатель) при температуре 4–36 °C (40–97 °F).
- Избегать воздействия прямых солнечных лучей. Превышение максимальной рекомендуемой температуры хранения может привести к ухудшению качества трубки (то есть потеря вакуума, окраска и т. Д.).
- Чтобы предотвратить обратный поток, поместите руку пациента в нижнее положение, держите трубку с колпачком вверх, отпустите жгут, как только кровь начнет течь в трубку, избегайте контакта содержимого трубки с колпачком или концом иглы во время венопункции
- Перед выполнением венопункции убедитесь, что следующие материалы легкодоступны: все необходимые пробирки для сбора крови, идентифицированные этикетки для положительной идентификации пациентов, иглы и держатели для взятия крови, спиртовой тампон для чистки места прокола, чистая марля, жгут, лейкопластырь или бинт, одобренный контейнер биологической опасности. Для защиты от воздействия переносимых с кровью патогенных микроорганизмов рекомендуется использовать соответствующие СИЗ (средства индивидуальной защиты) (например, перчатки, лабораторный халат, защитные очки и т. Д.).

Техника венопункции и Забор Образцов Крови:

Забор крови следует производить как можно быстрее, так как в пробирке для забора отсутствует антикоагулянт. Образец крови немедленно начнет коагулировать. Надевайте перчатки во время венопункции и при работе с пробирками для забора крови, чтобы минимизировать риск воздействия. Перед взятием крови протрите верхнюю часть крышки (ей) с помощью дезинфицирующих салфеток на ваш выбор. Снимите крышку над клапанной секцией иглы. Подготовьте участок венопункции с

соответствующим антисептиком. Не пальпировать область венопункции после чистки. Положите руку пациента вниз. Снимите кожу иглы. Выполните венопункцию, опустив руку вниз и крышку трубки сверху. При необходимости иммобилизируйте иглу с помощью клейкой ленты. Вставьте пробирку для сбора крови в держатель и на игольчатый клапан, пробивающий резиновую диафрагму пробирки для сбора крови. Центрируйте пробирки для сбора крови в держателе при проникновении в крышку, чтобы предотвратить проникновение боковой стенки и последующую преждевременную потерю вакуума. Удалите жгут, как только кровь появится в пробирке для сбора крови. Во время процедуры всегда удерживайте пробирку для сбора на месте, нажимая на нее большим пальцем. Это обеспечит полный вакуумный отсос. Трубка для сбора крови заполнится автоматически. Если в пробирку для сбора крови не поступает кровь или поток крови прекращается до сбора адекватного образца, предлагаются следующие шаги для завершения удовлетворительного сбора::

- Выдвиньте пробирку для забора крови вперед, чтобы убедиться, что крышка пробита.
- Подтвердите правильное положение иглы в вене.
- Если кровь все еще не течет, удалите и, соответственно, выбросьте пробирку для сбора. Получите новую пробирку для сбора и вставьте в держатель.
- Если вторая трубка для сбора не тянет, извлеките и утилизируйте иглу и трубку для сбора. Повторите процедуру.
- Когда линия заполнения максимального объема пробирки для сбора крови будет достигнута, осторожно выньте ее из держателя. Повторите со второй пробиркой для сбора крови.

Аккуратно переверните каждую пробирку сразу после извлечения из держателя. Не встряхивайте пробирки с пробой крови. Энергичное перемешивание может вызвать вспенивание или гемолиз. Недостаточное или замедленное смешивание в пробирках с сывороткой может привести к задержке свертывания.

По завершении забора крови извлеките иглу из вены. Активируйте предохранительный механизм (защитную крышку) иглы, нажав на втулку с обеих сторон для фиксации. Сдвиньте предохранительный механизм назад до щелчка. Не надевайте колпачок повторно на иглу: это повышает риск травмы иглой и контакта с кровью. Исползованную иглу с держателем утилизируйте с помощью подходящего контейнера для биологически опасных отходов. Нажимайте на место прокола сухим стерильным тампоном, пока кровотечение не прекратится. При желании наложить повязку, как только произошло свертывание. Рекомендуется хранить заполненные пробирки в вертикальном положении. После того как вторая пробирка заполнена, извлеките ее и поместите первую и вторую пробирки в центрифугу на противоположных участках для уравнивания ротора. Закройте крышку центрифуги IntraSpin® и нажмите кнопку START (ПУСК) для вращения в течение 12 МИНУТ.

Если требуется более двух пробирок, выполните альтернативную процедуру: после наполнения и осторожного переворачивания первых двух пробирок крови немедленно поместите их в центрифугу IntraSpin одну напротив другой, чтобы обеспечить правильную балансировку центрифуги. Закройте крышку и нажмите кнопку START и дайте центрифуге поработать, пока вы соберете оставшиеся пробирки с кровью. Нажмите кнопку STOP и дайте центрифуге полностью остановиться. Крышка откроется; немедленно поместите оставшиеся пробирки в центрифугу напротив друг друга, чтобы обеспечить надлежащий баланс, и нажмите кнопку START для сброса и завершения рекомендуемого протокола.

для балансировки ротора центрифуги всегда помещайте пробирки попарно в противоположных сторонах. Пробирки всегда должны быть сбалансированы в роторе перед нажатием кнопки START (ПУСК). В противном случае это может привести к серьезному повреждению центрифуги, неправильной коагуляции и/или разделению. Если пробирки не сбалансированы должным образом, во время центрифугирования будет слишком много вибрации, что приведет к плохому фибриновому сгустку L-PRF.

Если количество образцов крови для центрифугирования нечетное, поместите балансировочную пробирку с белым колпачком (например, 455001), наполненную водой до обозначенной сплошной линии, напротив пробирки без пары в роторе. Это позволит обеспечить надлежащую балансировку центрифуги.

начните центрифугирование сразу же после забора образцов крови. Задержки влияют на процедуру разделения крови и приводят к плохому фибриновому сгустку L-PRF.

7 ПОДГОТОВКА L-PRF

После центрифугирования видны три сегмента:

1. Верхний сегмент • плазма с низким содержанием тромбоцитов (PPP).
2. Средний сегмент • сгусток фибрина: L-PRF.
3. Нижний сегмент • сгусток эритроцитов.

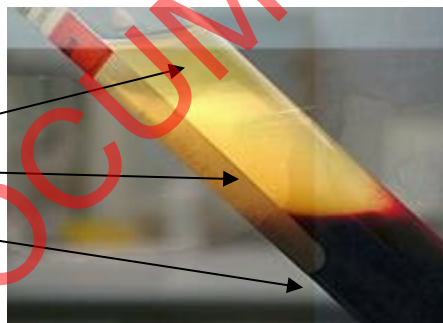

Фибриновые мембраны или пробки L-PRF должны быть приготовлены относительно быстро: через 0-15 минут после центрифугирования, иначе сгусток сжимается в объеме, высвобождая захваченную сыворотку. После центрифугирования снимите резиновые пробки с каждой пробирки. Используя хирургический пинцет, удалите сгусток L-PRF из трубки. Аккуратно очистите сгусток эритроцитов от фибринового сгустка L-PRF® чуть ниже соединения, используя шпатель с двумя биоматериалами-носителями, чтобы к сгустку L-PRF было прикреплено только минимальное остаточное количество красных кровяных клеток. Поместите фибриновый сгусток на перфорированный лоток Xpression.

8 ПОДГОТОВКА МАТРИЦЫ ФИБРИНА

Протокол №1- Мембрана L-PRF

Поместите каждый из фибриновых сгустков в перфорированный лоток Xpression. После того как все фибриновые сгустки размещены, поместите пластину сжатия Xpression и утяжеленную крышку Xpression поверх фибриновых сгустков, не оказывая никакого давления на сгустки.

Позвольте весу лотка медленно НАДАВЛИВАТЬ на сгустки фибрина, пока экссудат не отфильтруется на дно лотка. Не применяйте давление к утяжеленному покрытию. Гравитационное усилие на утяжеленном покрытии будет мягко сжимать сгусток и выделять сыворотку из сгустка L-PRF без повреждения фибриновой сети.

Подождите не менее 5 минут, прежде чем удалять и использовать любые фибриновые мембраны. Не удаляйте фибриновые мембраны до фактического времени использования. Фибриновая мембрана может оставаться в Xpression Box на срок до 3 часов.



Протокол №2 Штекер L-PRF

Поместите фибриновый сгусток внутри белого цилиндра изготовления пробки. Используйте поршень, чтобы медленно вдавливать сгусток внутри белого цилиндра изготовления пробки L-PRF. Продолжайте нажимать, пока верхний край поршня не окажется на одном уровне с верхним краем белого цилиндра изготовления заглушки L-PRF. С помощью этой техники можно будет сформировать толстую круглую фибриновую пробку для экстракционной розетки. Для одного зуба может быть достаточно одной заглушки L-PRF. Для премоляров может понадобиться два штекера L-PRF®, а для моляров — три штекера L-PRF®, в зависимости от размера экстракционной лунки и размера созданного сгустка фибрина.

Рабочие характеристики L-PRF® обеспечивают превосходное средство для использования в сочетании с предпочтительным биоматериалом. При использовании любого из следующих протоколов смешивания, биоматериал попадает в фибриновый матрикс, улучшая его рабочие и биологические свойства.

Протокол №3- Смесь биоматериала/L-PRF

Чтобы создать смесь, похожую на шпатлевку, которой можно аккуратно придать нужную форму и толщину с помощью инструмента для биоматериалов, используйте следующий протокол.: Аккуратно нарежьте фибриновую мембрану L-PRF на маленькие кусочки в стерильной посуде с помощью хирургических изогнутых ножниц. Добавьте необходимый объем костного имплантационного материала. Тщательно перемешайте L-PRF® и костный имплантационный материал. Эта смесь может быть помещена в дефекты, используя Двойной шпатель из биоматериала.



Протокол №4- Смесь биоматериала/ матрикса L-PRF

Поместите заранее определенное количество костного имплантационного материала в стерильную чашу или лоток. Окуните экспрессированную мембрану (ы) L-PRF или кусочки мембраны L-PRF в материал трансплантата, покрывая всю площадь поверхности мембраны L-PRF материалом трансплантата. В качестве альтернативы имплантационный материал можно высыпать на мембрана L-PRF®, покрывая всю поверхность имплантационным материалом. Примечание: более влажная мембрана L-PRF может удерживать немного больше привитого материала, чем более сухая мембрана L-PRF. Материал трансплантата должен прилипнуть к поверхности L-PRF, однако при желании осторожно прижмите материал трансплантата к мембране L-PRF. Хирургический пинцет можно использовать для помещения этой смеси в дефект.

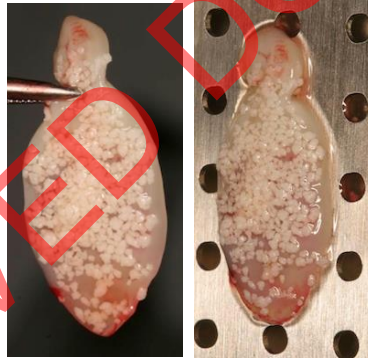

Протокол №5- Биоматериал Увлажнение

Добавьте желаемое количество материала костного трансплантата в стерильную миску или поднос. Используйте экссудат со дна сборного лотка Xpression для увлажнения материала трансплантата. Тщательно перемешайте экссудат и материал костного трансплантата. Эта смесь может быть помещена в дефекты, используя Двойной шпатель из биоматериала.

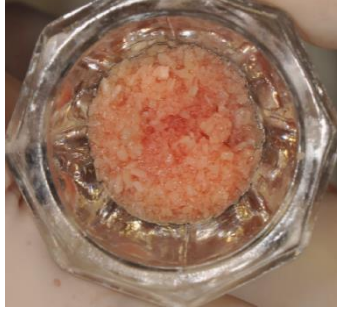

9 ОЧИСТКА И СТЕРИЛИЗАЦИЯ КОМПЛЕКТАЦИИ РЕГЕНЕРАЦИИ ТКАНЕЙ

Блок Xpression® позволяет производить фибриновые мембраны постоянной толщины с легкостью. Экссудат может быть собран из лотка для сбора Xpression под перфорированным лотком Xpression. В комплект Xpression Box входят цилиндры для изготовления заглушек L-PRF и поршень для изготовления заглушек L-PRF, которые легко подходят к гнездам после извлечения.



взвешенное покрытие
Xpression



Компрессивная пластина
Xpression



Перфорированный лоток
Xpression в коллекционном
лотке Xpression

Коробка Xpression и вспомогательные инструменты НЕ поставляются стерильными. Удалите и утилизируйте все транспортировочные материалы перед первоначальной стерилизацией. Очищайте и стерилизуйте Xpression Box и вспомогательные инструменты перед каждым использованием.

Разберите Блок Xpression перед каждым циклом очистки и стерилизации, чтобы избежать инкапсуляции мусора, обесцвечивания материала и / или неадекватной сушки компонентов. Цилиндры изготовления заглушки L-PRF и поршневая втулка не предназначены для извлечения из перфорированного лотка Xpression для очистки и стерилизации.

очищающий: (1) Удалите любой видимый мусор из компонентов Блок Xpression и вспомогательных инструментов, используя щетку с мягкой щетиной и чистящее или дезинфицирующее средство широкого спектра действия, такое как Nu-Friedy's Enzymax® или аналогичный. Тщательно промойте. (2) Поместите компоненты Блок Xpression и вспомогательные инструменты в емкость соответствующего размера с тем же раствором и обработайте ультразвуком в течение 10 минут. Тщательно промойте. (3) Промойте компоненты Блок Xpression и вспомогательные инструменты изопропиловым спиртом, чтобы удалить остатки мыла и минералы. (4) Промокните компоненты Блок Xpression и вспомогательные инструменты безворсовым полотенцем и полностью высушите на воздухе. Обратитесь к маркировке чистящего средства, используемого для инструкций по применению.

стерилизация: (1) Поместите повторно собранную коробку Xpression и вспомогательные инструменты в очищенный FDA стерилизационный пакет или обертку. (2) Выполните один из следующих квалифицированных циклов стерилизации:

Метод стерилизации	температура	Время контакта	Минимальное время высыхания
Предварительно вакуумный пар (ANSI/AAMI ST79)	132°C (270°F)	4 мин	20-30 минут
Предварительно вакуумный пар (UK DoH Health Technical Memorandum 01-01)	134°C (273°F)	3 мин	20-30 минут

Внимание! Неправильная очистка может привести к неадекватной стерилизации. Невозможность полностью высушить компоненты Xpression Box и вспомогательные инструменты во время автоклавирования может оставить влагу и вызвать изменение цвета и окисление. Использование перекиси водорода или других окислителей приведет к повреждению поверхности компонентов Xpression Box и вспомогательных инструментов. Рекомендуется периодически проверять, чистить и калибровать автоклавное оборудование, чтобы убедиться, что устройство остается в исправном рабочем состоянии.

10 ОЧИСТКА И ТЕХНИЧЕСКОЕ ОБСЛУЖИВАНИЕ ЦЕНТРОБЕЖА

Устройство может быть загрязнено. Выньте сетевую вилку перед очисткой. Центрифуги, роторы и принадлежности нельзя очищать в моечных машинах. Их следует очищать исключительно вручную и дезинфицировать жидкостями. Температура воды должна быть 20–25 °C. Можно использовать только моющие / дезинфицирующие средства с pH от 5 до 8, которые не содержат едких щелочей, пероксидов, соединений хлора, кислот и щелочных растворов. Чтобы предотвратить появление коррозии из-за чистящих или дезинфицирующих средств, необходимо строго соблюдать инструкции по применению, предоставленные производителем моющего или дезинфицирующего средства.

Регулярно очищайте корпус центрифуги и камеру центрифуги, используя мыло или мягкое моющее средство и влажную ткань, если это необходимо, чтобы предотвратить коррозию из-за налипших загрязнений. Ингредиенты подходящих моющих средств включают мыло, анионные поверхностно-активные вещества и неионные поверхностно-активные вещества. После использования моющего средства удалите его остатки, протерев влажной тканью. Поверхности необходимо высушивать сразу после очистки. В случае образования конденсата, высушите камеру центрифугирования, протерев ее абсорбирующей тканью. Аккуратно протирайте резиновое уплотнение камеры центрифуги тальком или средством для ухода за резиной после каждой очистки. Камера центрифугирования должна быть проверена на предмет повреждений. При обнаружении повреждений, влияющих на безопасность, центрифугу запрещено эксплуатировать. В этом случае необходимо уведомить службу поддержки.

Для дезинфекции поверхности, если инфекционные материалы проникают в центробежную камеру, они должны быть немедленно продезинфицированы. Ингредиенты подходящих дезинфицирующих средств включают этанол, n-пропанол, этилгексанол, анионные поверхностно-активные вещества и

ингибиторы коррозии. После использования дезинфицирующего средства удалите его остатки влажной тканью. Поверхности необходимо высушивать сразу после дезинфекции.

Для удаления радиоактивных загрязнений, средство должно иметь особую маркировку, обозначающую, что оно предназначено для удаления радиоактивных загрязнений. Ингредиенты подходящих агентов для удаления радиоактивных загрязнений включают анионные поверхностно-активные вещества, неионные поверхностно-активные вещества, полигидратированный этанол. После удаления радиоактивных загрязнений удалите остатки средства влажной тканью. Поверхности необходимо высушивать сразу после удаления радиоактивных загрязнений.

11 РОТОР И ПРИНАДЛЕЖНОСТИ ЧИСТКА И ОБСЛУЖИВАНИЕ

Чтобы избежать коррозии и изменения материалов, ротор и принадлежности необходимо регулярно очищать с использованием мыла или мягкого чистящего средства и влажной ткани. Очистку рекомендуется проводить как минимум раз в неделю. Загрязнения необходимо удалять немедленно.

Ингредиенты подходящих моющих средств включают мыло, анионные поверхностно-активные вещества и неионные поверхностно-активные вещества. После использования моющих средств удалите их остатки, промыв водой (только снаружи центрифуги), или протерев влажной тканью. Ротор и принадлежности необходимо высушивать сразу после очистки. Ежедневно проверяйте ротор и принадлежности на предмет износа и коррозии. Если ротор и принадлежности имеют признаки износа или коррозии, их больше нельзя использовать. Проверяйте плотность посадки ротора ежедневно. Если на ротор или принадлежности попадет зараженный материал, необходимо провести соответствующую дезинфекцию.

Ингредиенты подходящих дезинфицирующих средств включают этанол, н-пропанол, этилгексанол, анионные поверхностно-активные вещества и ингибиторы коррозии. После использования дезинфицирующих средств удалите их остатки, промыв водой (только снаружи центрифуги), или протерев влажной тканью. Ротор и принадлежности необходимо высушивать сразу после дезинфекции.

Для удаления радиоактивных загрязнений, средство должно иметь особую маркировку, обозначающую, что оно предназначено для удаления радиоактивных загрязнений. Ингредиенты подходящих агентов для удаления радиоактивных загрязнений включают анионные поверхностно-активные вещества, неионные поверхностно-активные вещества и полигидратированный этанол. После удаления радиоактивных загрязнений удалите остатки средства, промыв водой (только снаружи центрифуги), или протерев влажной тканью. Ротор и принадлежности необходимо высушивать сразу после удаления радиоактивных загрязнений.

Ротор может быть автоклавирован при 121 ° C / 250 ° F в течение 20 минут и высушен соответствующим образом. После 10 циклов автоклавирования ротор необходимо заменить по соображениям безопасности. Автоклавирование ускоряет процесс старения пластмасс и может вызвать изменение цвета. После автоклавирования дождитесь охлаждения ротора до температуры окружающей среды, прежде чем снова его использовать. Степень стерильности определить невозможно.

Период использования ротора ограничен 50 000 рабочих циклов (центрифугирование) или 5 лет, в зависимости от того, что наступит раньше. Максимально допустимое количество циклов работы

указано на роторе. После достижения максимально допустимого количества циклов работы ротора (указанных на нем) его больше нельзя использовать по соображениям безопасности. Устройство оснащено счетчиком циклов, который подсчитывает количество рабочих циклов (циклов центрифугирования).

В случае перелома трубки все сломанные части и кровь должны быть полностью удалены. Центрифуга должна быть тщательно очищена, как указано, и резиновые вставки, а также пластиковые втулки ротора должны быть заменены.

12 ТЕХНИЧЕСКИЕ ХАРАКТЕРИСТИКИ CENTRIFUGE

Тип модели	IS220Z	IS110Z
Сетевое напряжение ($\pm 10\%$)	200 - 240 В 1~	100 - 127 В 1~
Частота сети	50 - 60 Гц	50 - 60 Гц
Подключенная нагрузка	100 В·А	100 В·А
Потребление тока	0.5 А	1.0 А
Вместимость	8 x 10 мл	
Максимально допустимая плотность	1.2 кг/дм ³	
Максимальная скорость (об/мин)	6,000	
Относительное центробежное ускорение	3,461	
Кинетическая энергия	750 Н·м	
Место установки	Только в помещении	
Высота	До 2000 м над уровнем моря	
Температура окружающей среды для	От 5°C до 40°C	
Относительная влажность при эксплуатации	Максимальная относительная влажность 80 % для температур до 31 °C, линейное снижение до 50 %	
Категория избыточного напряжения	II	
Степень загрязнения	2	
Класс защиты устройства	I	
	Не подходит для использования во взрывоопасных зонах.	
Электромагнитный шум	EN/IEC 61326-1, класс В	Класс В по классификации
Уровень шума (зависит от ротора)	≤ 50 дБ (А)	
Ширина центрифуги	261 mm	
Глубина центрифуги	353 mm	
Высота центрифуги	228 mm	
Вес центрифуги	Около 9 кг	

13 РУКОВОДСТВО ПО ЭКСПЛУАТАЦИИ CENTRIFUGE

Обязательно снимите транспортное крепежное устройство, состоящее из 2 винтов (a) и 2 распорок (b). Храните крепежное устройство для транспортировки в безопасном месте, поскольку перед транспортировкой его нужно установить снова. Устройство можно транспортировать только с установленным крепежным устройством для транспортировки. Двигатель зафиксирован с целью защиты устройства от повреждений во время транспортировки. Это крепежное устройство для транспортировки должно быть снято перед началом эксплуатации устройства.

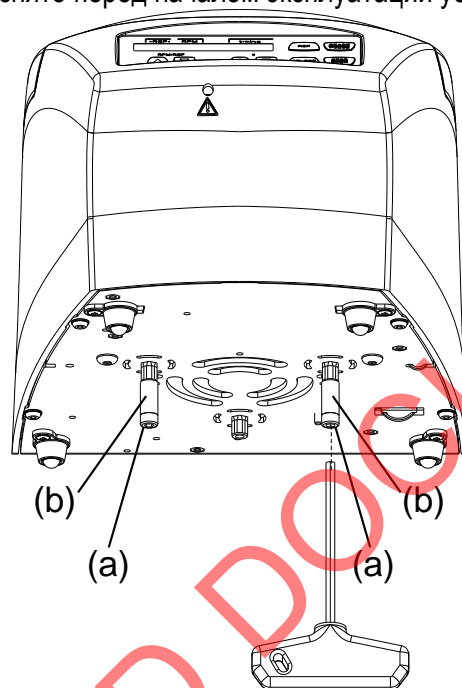



13.1 ПЕРВИЧНАЯ ЭКСПЛУАТАЦИЯ

- Снимите транспортное крепежное устройство с нижней стороны центрифуги.
- Установите центрифугу на устойчивой ровной поверхности в подходящем месте. Во время работы центрифуги в соответствии люди, опасные вещества или предметы не должны находиться на расстоянии ближе 300 мм к центрифуге.
- Вентиляционные отверстия не должны быть заблокированы. Расстояние от вентиляционных и других отверстий центрифуги должно составлять 300 мм.
- Проверьте, соответствует ли сетевое напряжение указанному на предупреждающей табличке.
- Подключите центрифугу с помощью шнура питания к стандартной розетке.
- Включите сетевой выключатель.
- На панели отображаются следующие изображения: тип модели центрифуги, версия программного обеспечения и последние использованные данные центрифугирования.
- Если крышка закрыта, появится сообщение Open the lid (Откройте крышку). В этом случае откройте крышку для отображения параметров центрифугирования.

13.2 ОТКРЫТИЕ И ЗАКРЫТИЕ КРЫШКИ ЦЕНТРИФУГИ

Крышка может быть открыта только в том случае, если центрифуга включена и ротор неподвижен. Когда счетчик циклов активирован, после цикла центрифугирования при открытии крышки на короткое время отображается оставшееся количество рабочих циклов (циклов центрифугирования).



Чтобы открыть крышку, нажмите следующую клавишу . Крышка разблокирована двигателем.  указывает на то, что крышка открыта.

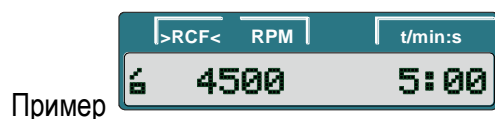

Не держите пальцы между крышкой и корпусом. Не захлопывайте крышку.

Чтобы закрыть крышку, слегка нажмите на передний край крышки.  означает, что крышка закрыта.



13.3 АВАРИЙНАЯ РАЗБЛОКИРОВКА

В случае сбоя питания крышку невозможно разблокировать при помощи двигателя. Аварийную разблокировку необходимо выполнять вручную. Чтобы разблокировать в чрезвычайной ситуации, Выключите сетевой выключатель (положение переключателя «0»). Посмотрите в окошко крышки, чтобы убедиться в остановке ротора. Открывайте крышку только после остановки ротора. Вставьте шестигранный ключ горизонтально в отверстие (A) и осторожно поворачивайте против часовой стрелки (влево), пока крышка не откроется. **ОСТОРОЖНО!** Поворот шестигранного шестигранного ключа по часовой стрелке (вправо) может привести к повреждению системы блокировки. Выньте шестигранный ключ из отверстия.

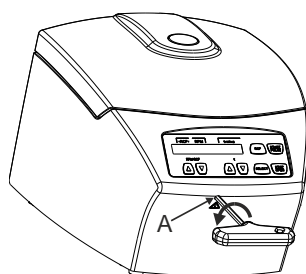

13.4 УСТАНОВКА И ИЗВЛЕЧЕНИЕ РОТОРА

Снять ротор, раскрутите зажимную гайку ротора, повернув ее против часовой стрелки при помощи универсального ключа (входит в комплект поставки), и поднимите до точки приложения подъемной силы. После преодоления точки приложения подъемной силы ротор освобождается от конуса вала двигателя. Проворачивайте зажимную гайку до тех пор, пока не сможете снять ротор с вала двигателя. Снимите ротор с вала двигателя.

Установить ротор, очистите вал двигателя (A) и отверстие ротора, а затем нанесите тонкий слой смазки на вал двигателя. Частицы грязи между валом двигателя и ротором мешают плотной посадке ротора и приводят к нестабильной работе. Поместите ротор вертикально на вал двигателя. При насаживании ротора маркерный штрих (B) на роторе должен быть параллелен обеим поверхностям (C) на валу двигателя. Затяните зажимную гайку ротора с помощью универсального ключа (входит в комплект поставки), повернув ее по часовой стрелке. Проверьте плотность посадки ротора.

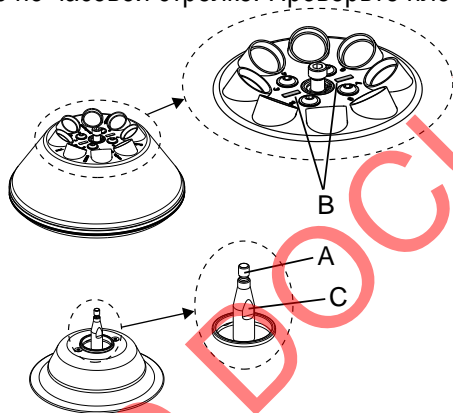

Роторы следует загружать симметрично. Трубки крови должны быть равномерно распределены по всем положениям ротора.

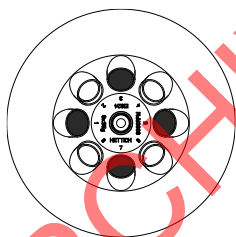

Ротор загружен равномерно

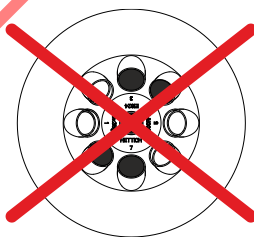

Ротор загружен неравномерно

Запрещено!

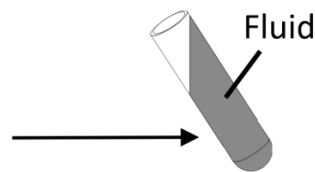

Centrifugal force

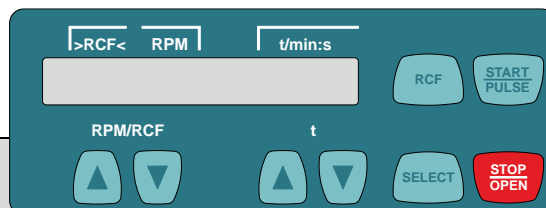

Пробирки для крови можно заполнять только вне центрифуги. Максимальное количество наполнения для пробирок для крови указано на самих пробирках и не должно превышать максимальный вес, указанный на роторе. Емкости для центрифуг можно заполнять только до такого объема, чтобы во время работы центрифуги из них не выливалась жидкость. При загрузке ротора нельзя, чтобы жидкость попадала в ротор или камеру центрифугирования. Чтобы поддерживать минимальные различия в весе внутри емкости для центрифуги, рекомендуется постоянный уровень заполнения в пробирках.

13.5 ДИСПЛЕЙ ОПИСАНИЕ ЭЛЕМЕНТОВ



Символ / Ключ панели	Описание
	Крышка разблокирована.
	Крышка заблокирована.
	Отображение вращения. Пока ротор вращается, отображается символ вращения, когда ротор вращается.
	Прямой ввод скорости. Если клавишу зажать, значения будут изменяться с увеличивающейся скоростью.
	Прямой ввод времени работы. Настраивается с шагом в 1 секунду до одной минуты, начиная с 1 минуты с шагом в 1 минуту. Ввод параметров центрифугирования. Если клавишу зажать, значения будут изменяться с увеличивающейся скоростью.
	Активировать индивидуальные параметры. Каждое нажатие клавиши активирует следующий параметр. Удерживайте клавишу нажатой в течение 8 секунд позвонить "MACHINE MENU" (МЕНЮ УСТРОЙСТВА). На экране Machine Menu выберите такие опции меню: «-> Info» (Информация), «-> Settings» (Настройки) и «-> Time & Cycles» (Время и циклы). Прокрутите вперед опции меню.
	Переключение между отображением скорости (об / мин) и отображением относительной центробежной силы (>RCF<). Значения RCF отображаются между стрелками ><.
	Начать цикл центрифугирования. Кратковременное центрифугирование. Центрифугирование происходит, пока клавиша удерживается нажатой. Вывод опций меню «-> Info», «-> Settings» и «-> Time & Cycles».
	Завершить цикл центрифугирования. Ротор замедляется согласно предварительно выбранному периоду торможения. Двойное нажатие клавиши запускает аварийную остановку. Разблокировать крышку.
t/min (время/минуты)	Время работы. Настраивается в диапазоне 1–99 минут с шагом в 1 минуту.
t/sec (время/секунды)	Время работы. Настраивается в диапазоне 1–59 секунд с шагом в 1 секунду. Непрерывная работа «-:--». Установите параметры t/min и t/sec на ноль.
Об/мин	Скорость. Можно установить числовое значение от 200 об/мин до максимальной скорости ротора. Настраивается с шагом в 10.
> ОЦУ <	Относительное центробежное ускорение. Может быть задано числовое значение, которое приводит к скорости от 200 об/мин до максимальной скорости ротора. Настраивается с шагом в 1. Ввод относительного центробежного ускорения (ОЦУ) возможен только при активированном отображении ОЦУ (>ОЦУ<). Относительное центробежное ускорение (ОЦУ) зависит от радиуса центрифугирования (РАД). После ввода ОЦУ убедитесь, что установлен правильный радиус центрифугирования.
РАД/мм	Радиус центрифугирования. Настраивается в диапазоне от 10 до 250 мм с шагом в 1 мм. Ввод радиуса центрифугирования возможен только при активированном отображении ОЦУ (>ОЦУ<).
~_DEC	Период торможения. fast (быстро) = короткий период остановки, slow (медленно) = длительный период остановки.

13.6 ПРЯМОЙ ВВОД ПАРАМЕТРОВ ЦЕНТРИФУГИРОВАНИЯ

Такие параметры, как скорость (об/мин), относительное центробежное ускорение (ОЦУ), радиус центрифугирования (РАД) и время работы можно ввести напрямую при помощи клавиш   не нажимая предварительно клавишу . Настроенные параметры центрифугирования сохраняются только после начала цикла центрифугирования.

Для скорости (об/мин):



Нажмите клавишу, чтобы активировать отображение оборотов в минуту (об/мин), при необходимости.



Установите необходимое значение при помощи клавиш.

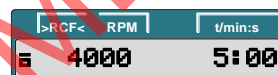
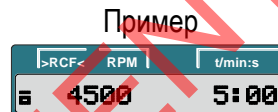

Для относительное центробежное ускорение (ОЦУ) и радиус центрифугирования (РАД):



Нажмите клавишу, чтобы активировать отображение относительного центробежного ускорения (>ОЦУ<), при необходимости.

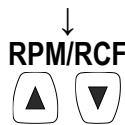

Установите необходимое значение ОЦУ при помощи клавиш.

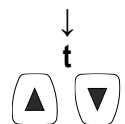

Установите необходимый радиус центрифугирования при помощи клавиш при необходимости.

Пример

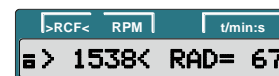
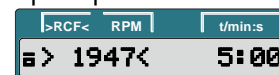

Время работы:

При установке до 1 минуты время работы можно настроить с шагом в 1 секунду, а начиная с 1 минуты — только с шагом в 1 минуту. Для непрерывной работы параметры t/min (время/минуты) и t/sec (время/секунды) необходимо установить на ноль. На экране времени появится (t/min:s), «--:--».



Пример

t Установите необходимое значение при помощи клавиш.



13.7 ВВОД ПАРАМЕТРОВ ЦЕНТРИФУГИРОВАНИЯ ПРИ ПОМОЩИ КЛАВИШИ SELECT (ВЫБОР)

Время работы может быть установлено в минутах и секундах (параметры **t/min** (время/минуты) и **t/sec** (время/секунды)). Для непрерывной работы параметры **t/min** и **t/sec** необходимо установить на ноль. На экране времени появится (t/min:s), «--:--».

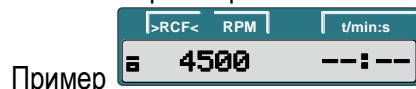

Относительное центробежное ускорение (ОЦУ) зависит от радиуса центрифугирования (РАД). Во время ввода ОЦУ отображается установленный радиус центрифугирования. Если ни одна клавиша не будет нажата в течение 8 секунд после выбора или во время ввода параметров, на дисплее отобразятся предыдущие значения. После этого необходимо будет заново вводить параметры.

Чтобы сохранить параметры, нажмите клавишу . При введении нескольких параметров клавишу необходимо нажать после настройки последнего параметра. Ввод параметров можно отменить в любое время, нажав клавишу . В этом случае настройки не сохраняются.

Нажмите клавишу, чтобы активировать отображение оборотов в минуту (об/мин) или относительного центробежного ускорения (>ОЦУ<), при необходимости.

Нажмите клавишу. t/min: время работы, минуты.

Установите необходимое значение при помощи клавиш.

Нажмите клавишу. t/sec: время работы, секунды.

Пример
Отображение оборотов в минуту (об/мин)

Пример
Отображение относительного центробежного ускорения (>ОЦУ<)

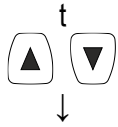

Установите необходимое значение при помощи клавиш.



Нажмите клавишу.
Об/мин: скорость.
РАД/мм: радиус центрифугирования.
Отображение и введение радиуса центрифугирования возможно только при активированном отображении ОЦУ (>ОЦУ<).

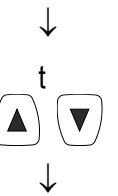

Установите необходимое значение при помощи клавиш.

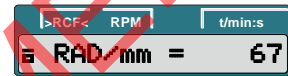
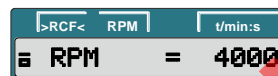

Нажмите клавишу.
Р: радиус центрифугирования.
ОЦУ: относительное центробежное ускорение.

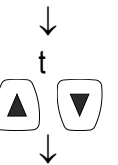

Установите необходимое значение при помощи клавиш.



Нажмите клавишу.
~_DEC: период торможения.
fast (быстро) = короткий период остановки.
slow (медленно) = длительный период остановки.

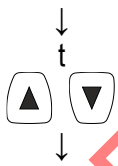
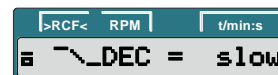

Установите необходимое значение при помощи клавиш.



Нажмите кнопку, чтобы сохранить настройки.

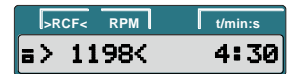

13.8 ДИСПЛЕЙ ПАНЕЛИ УПРАВЛЕНИЯ

После каждого цикла центрифугирования при разблокировании крышки на короткое время отображается оставшееся количество рабочих циклов (циклов центрифугирования).

Пример 

Если при загрузке ротора была превышена допустимая разница в массах, цикл центрифугирования прерывается во время его начала, и "IMBALANCE" будет отображаться

Пример 

Цикл центрифугирования можно прервать в любое время нажатием клавиши . Во время цикла можно выбирать и изменять параметры центрифугирования. Однако измененные значения будут применены только к текущему циклу центрифугирования и не будут сохранены.

При помощи клавиши  можно переключаться между экранами настройки оборотов в минуту (об/мин) и относительного центробежного ускорения (>ОЦУ<) в любое время. При работе с экраном относительного центробежного ускорения (>ОЦУ<) необходимо ввести радиус центрифугирования. Дальнейшая работа с центрифугой возможна только после открытия крышки. Отобразятся ошибки работы и неисправности.

Пример 

13.9 ЦЕНТРИФУГИРОВАНИЕ С ЗАДАННЫМ ВРЕМЕНЕМ

 Нажмите клавишу, чтобы активировать отображение оборотов в минуту (об/мин) или относительного центробежного ускорения (>ОЦУ<), при необходимости.

↓
Введите необходимые параметры центрифугирования

 Нажмите клавишу, чтобы начать цикл центрифугирования. Во время цикла центрифугирования отображается скорость ротора или полученное значение ОЦУ, а также оставшееся время.

↓

Пример
Отображение оборотов в минуту (об/мин)







Пример
Отображение относительного центробежного ускорения (>ОЦУ<)







По истечении времени или при прерывании цикла центрифугирования нажатием клавиши



происходит остановка с заданным периодом торможения. Отображается период торможения. ~\f

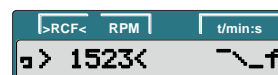
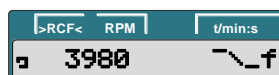

13.10 НЕПРЕРЫВНАЯ РАБОТА

Пример
Отображение оборотов в минуту (об/мин)

Пример
Отображение относительного центробежного ускорения (>ОЦУ<)



Нажмите клавишу, чтобы активировать отображение оборотов в минуту (об/мин) или относительного центробежного ускорения (>ОЦУ<), при необходимости.

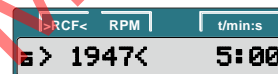
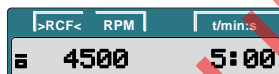

↓
Ввод необходимых параметров центрифугирования. Установите параметры t/min (время/минуты) и t/sec (время/секунды) на ноль

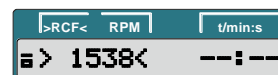

Нажмите клавишу, чтобы начать цикл центрифугирования. Во время цикла центрифугирования отображается скорость ротора или полученное значение ОЦУ, а также оставшееся время.

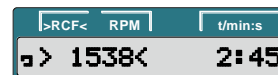
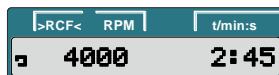

Нажмите клавишу, чтобы завершить цикл центрифугирования. Произойдет остановка с заданным периодом торможения. Отображается период торможения.

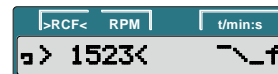
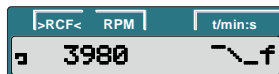

13.11 КРАТКОВРЕМЕННОЕ ЦЕНТРИФУГИРОВАНИЕ

Пример
Отображение оборотов в минуту (об/мин)

Пример
Отображение относительного центробежного ускорения (>ОЦУ<)



Нажмите клавишу, чтобы активировать отображение оборотов в минуту (об/мин) или относительного центробежного ускорения (>ОЦУ<), при необходимости.



↓
Введите необходимые параметры центрифугирования

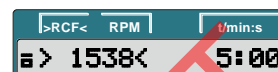

Нажмите клавишу и не отпускайте ее. Во время цикла центрифугирования отображается скорость ротора или полученное значение ОЦУ, а также прошедшее время.

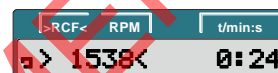

Отпустите клавишу, чтобы завершить цикл центрифугирования. Произойдет остановка с заданным периодом торможения. Отображается период торможения. ~\f

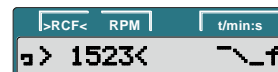

13.12 АВАРИЙНАЯ ОСТАНОВКА



Дважды нажмите клавишу. Аварийная остановка происходит с периодом торможения fast (быстро) (короткий период остановки). Отображается период торможения ~\f

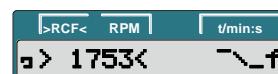
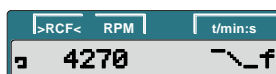

Пример
Отображение оборотов в минуту (об/мин)

Пример
Отображение относительного центробежного ускорения (>ОЦУ<)

13.13 СЧЕТЧИК ЦИКЛОВ

Центрифуга оснащена счетчиком циклов, который подсчитывает количество рабочих циклов (циклов центрифугирования). После каждого цикла центрифугирования при разблокировании крышки на короткое время отображается оставшееся количество рабочих циклов (циклов центрифугирования).

Пример

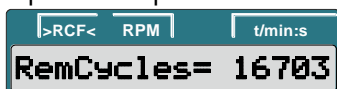

Если максимально допустимое количество рабочих циклов ротора было превышено, при каждом запуске центрифугирования отображается следующее, а цикл центрифугирования необходимо перезапустить. The Ротор необходимо незамедлительно заменить на новый по соображениям безопасности. После замены ротора счетчик циклов необходимо сбросить на значение «0»



13.14 СБРОС СЧЕТЧИКА ЦИКЛОВ НА «0»

После замены ротора счетчик циклов необходимо заново сбросить на ноль. Счетчик циклов можно сбросить на ноль только после того, как ротор был заменен на новый. При остановленном роторе счетчик циклов можно сбросить следующим образом. Процедуру можно прервать в любое время нажатием клавиши . В этом случае настройки не сохраняются.

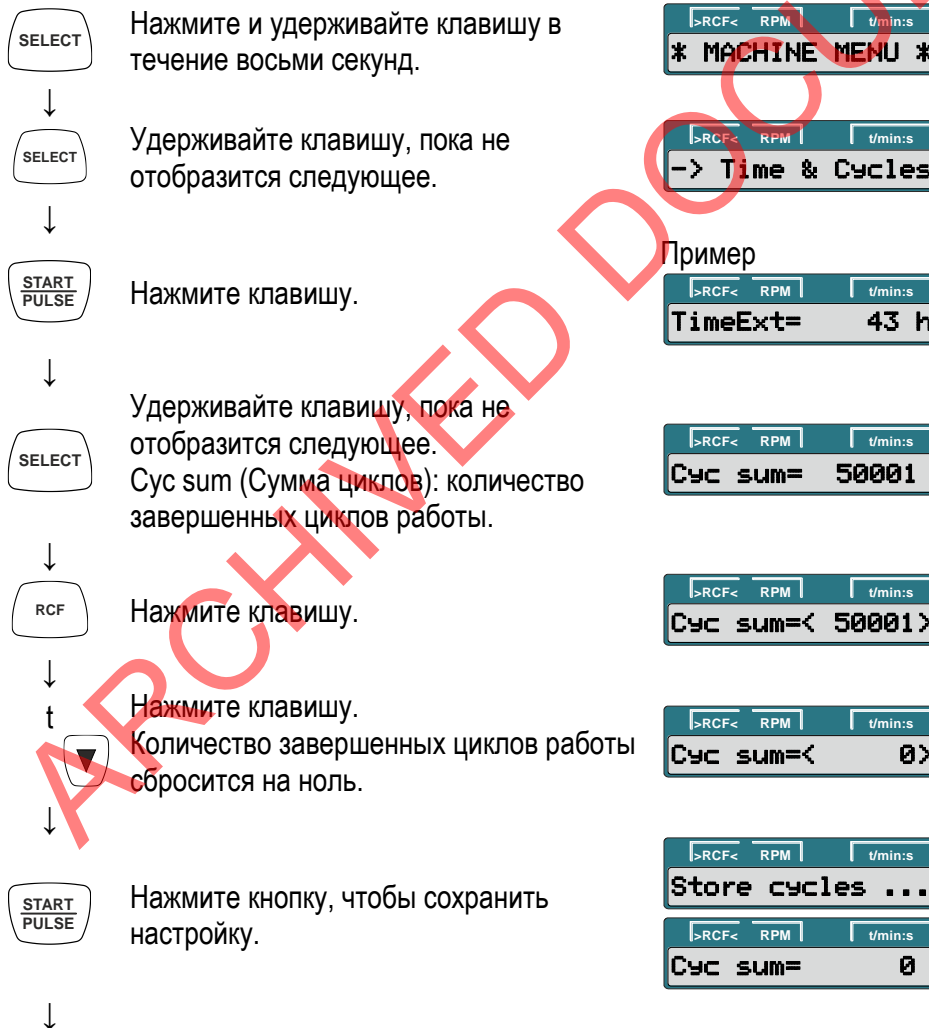



Нажмите клавишу дважды, чтобы выйти из меню "-> Time & Cycles(Время и циклы), или нажмите трижды, чтобы выйти из меню "* MACHINE MENU *" (МЕНЮ УСТРОЙСТВА).

Пример



13.15 НАСТРОЙКИ И ЗАПРОСЫ

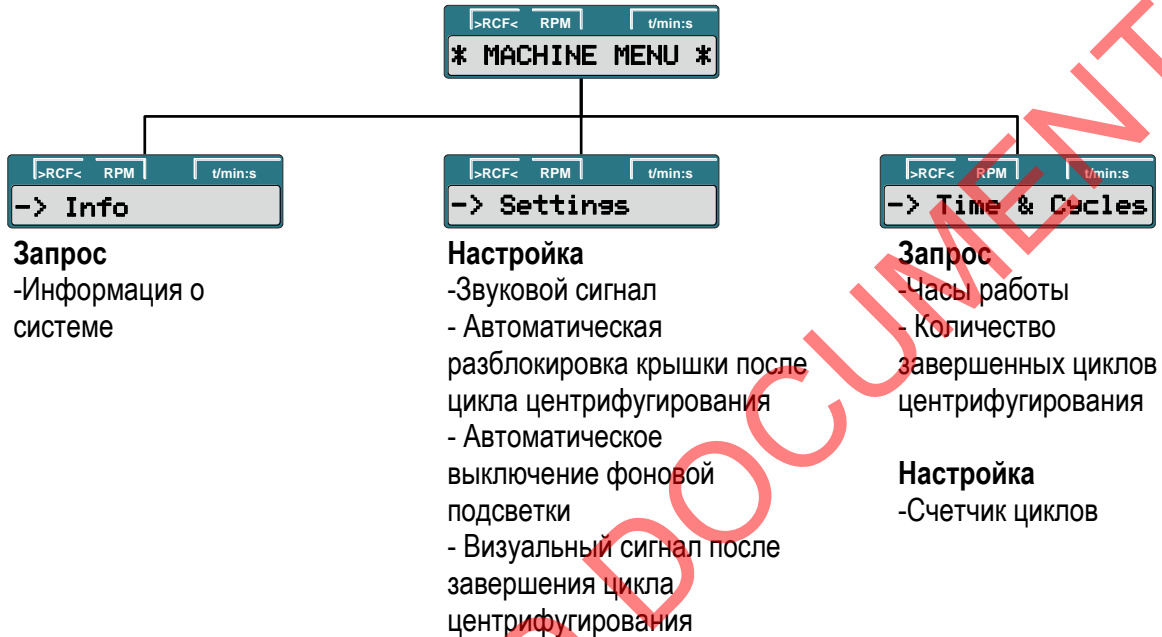

13.16 ЗАПРОС ИНФОРМАЦИИ О СИСТЕМЕ

Можно запросить следующую информацию о системе:

- модель устройства;
- версия программного обеспечения устройства;
- номер типа устройства;
- дата изготовления устройства;
- серийный номер устройства;
- тип преобразователя частоты;
- версия программного обеспечения преобразователя частоты.

При остановленном роторе запрос может выполняться следующим образом. Процедуру можно прервать в любое время нажатием клавиши .



Нажмите и удерживайте клавишу в течение восьми секунд.

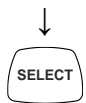

Нажмите клавишу.





Нажмите клавишу.
Модель устройства.



Нажмите клавишу.
Версия программного обеспечения
устройства.

Пример

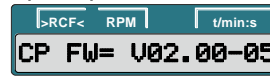

Нажмите клавишу.
Type#1 (Тип № 1): номер типа устройства.

Пример



Нажмите клавишу.
Type#2 (Тип № 2): продолжение номера
типа, если количество знаков превышает
поле экрана **Type#1**.

Пример

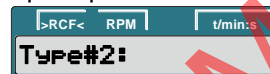

Нажмите клавишу.
Дата изготовления устройства.

Пример



Нажмите клавишу.
Серийный номер устройства.

Пример



Нажмите клавишу.
Тип преобразователя частоты.

Пример



Нажмите клавишу.
Версия программного обеспечения
преобразователя частоты.

Пример



Нажмите клавишу дважды, чтобы выйти
из меню "-> Info" (Информация), или нажмите
трижды, чтобы выйти из меню "* MACHINE
MENU *"(МЕНЮ УСТРОЙСТВА).





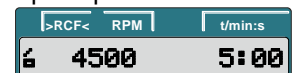













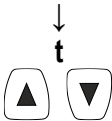





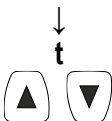



Пример



13.17 ЗВУКОВОЙ СИГНАЛ

Звуковой сигнал подается в следующих случаях (1) при возникновении неисправности с 2-секундным интервалом; (2) после окончания цикла центрифугирования и остановки ротора с 30-секундным интервалом. Звуковой сигнал отключается нажатием любой клавиши. При

остановленном роторе звуковой сигнал можно настроить следующим образом. Процедуру можно прервать в любое время нажатием клавиши . В этом случае настройки не сохраняются.

	<p>Нажмите и удерживайте клавишу в течение восьми секунд.</p>		
	<p>Удерживайте клавишу, пока не отобразится следующее.</p>		
	<p>Нажмите клавишу. End beep (Сигнал завершения): звуковой сигнал после завершения цикла центрифугирования. off (выкл.): сигнал деактивирован. on (вкл.): сигнал активирован.</p>		
	<p>При помощи клавиш настройте значение off или on.</p>		
	<p>Нажмите клавишу. Error beep (Сигнал об ошибке): звуковой сигнал после возникновения неисправности. off: сигнал деактивирован. on: сигнал активирован.</p>		
	<p>При помощи клавиш настройте значение off или on.</p>		
	<p>Нажмите клавишу. Beep volume (Громкость сигнала): громкость звукового сигнала. min (минимальная): тихо mid (средняя): средне max (максимальная): громко</p>		
	<p>min (минимальная): тихо mid (средняя): средне max (максимальная): громко</p>		
	<p>При помощи клавиш настройте значение min, mid или max.</p>		
	<p>Нажмите кнопку, чтобы сохранить настройку.</p>		



Нажмите клавишу один раз, чтобы выйти из меню "-> Settings" (Настройки), или нажмите дважды, чтобы выйти из меню "* MACHINE MENU *" (МЕНЮ УСТРОЙСТВА).



Пример:



13.18 ВИЗУАЛЬНЫЙ СИГНАЛ ПОСЛЕ ЗАВЕРШЕНИЯ ЦИКЛА ЦЕНТРИФУГИРОВАНИЯ

После завершения цикла центрифугирования подсветка дисплея будет мигать, визуальнo сигнализируя о завершении центрифугирования. Звуковой сигнал можно включить или выключить при остановленном роторе. Процедуру можно прервать в любое время нажатием клавиши .



Нажмите и удерживайте клавишу в течение восьми секунд.



Удерживайте клавишу, пока не отобразится следующее.



Нажмите клавишу.



Удерживайте клавишу, пока не отобразится одно из следующего.



End blinking (Мигание после завершения): мигание подсветки дисплея после завершения цикла центрифугирования.
off (выкл.): подсветка не будет мигать.
on (вкл.): подсветка будет мигать.



При помощи клавиш настройте значение **off** или **on**.



Нажмите кнопку, чтобы сохранить настройку.



Нажмите клавишу один раз, чтобы выйти из меню "-> Settings" (Настройки), или нажмите дважды, чтобы выйти из меню "* MACHINE MENU *" (МЕНЮ УСТРОЙСТВА).



Пример



13.19 АВТОМАТИЧЕСКАЯ РАЗБЛОКИРОВКА КРЫШКИ ПОСЛЕ ЦИКЛА ЦЕНТРИФУГИРОВАНИЯ

Можно настроить автоматическую разблокировку крышки после цикла центрифугирования. При остановленном роторе настройку можно выполнить следующим образом. Процедуру можно прервать в любое время нажатием клавиши . В этом случае настройки не сохраняются.



Нажмите и удерживайте клавишу в течение восьми секунд.

Удерживайте клавишу, пока не отобразится следующее.

Нажмите клавишу.

Удерживайте клавишу, пока не отобразится одно из следующего.

Lid AutoOpen (Автоматическое открытие крышки): автоматическая разблокировка крышки после цикла центрифугирования.

off (выкл.): крышка не будет разблокирована автоматически.

on (вкл.): крышка будет разблокирована автоматически.

При помощи клавиш настройте значение **off** или **on**.

Нажмите кнопку, чтобы сохранить настройку.















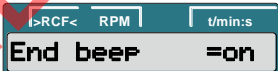

Нажмите клавишу один раз, чтобы выйти из меню "-> Settings" (Настройки), или нажмите дважды, чтобы выйти из меню "*MACHINE MENU*" (МЕНЮ УСТРОЙСТВА)..

Пример

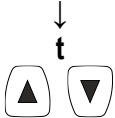
13.20 ПОДСВЕТКА ДИСПЛЕЯ

Для экономии энергии можно настроить таким образом, чтобы через 2 минуты после цикла центрифугирования подсветка дисплея выключалась. При остановленном роторе настройку можно выполнить следующим образом. Процедура. можно прервать в любое время нажатием клавиши

 . В этом случае настройки не сохраняются.

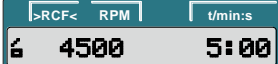
	Нажмите и удерживайте клавишу в течение восьми секунд.		
	Нажмите и удерживайте клавишу в течение восьми секунд.		
	Нажмите клавишу.		
	<p>Удерживайте клавишу, пока не отобразится одно из следующего.</p> <p>Power save (Энергосбережение): автоматическое выключение подсветки.</p> <p>Off (выкл.): автоматическое выключение деактивировано.</p> <p>On (вкл.): автоматическое выключение активировано.</p>		
	При помощи клавиш настройте значение off или on .		
	Нажмите кнопку, чтобы сохранить настройку.		
	<p>Нажмите клавишу один раз, чтобы выйти из меню "-> Settings" (Настройки), или нажмите дважды, чтобы выйти из меню "* MACHINE MENU *" (МЕНЮ УСТРОЙСТВА).</p>		<p>Пример</p> 

13.21 ЗАПРОС ИНФОРМАЦИИ О ЧАСАХ РАБОТЫ И КОЛИЧЕСТВЕ ЦИКЛОВ ЦЕНТРИФУГИРОВАНИЯ

Часы работы разделены на внутренние и внешние часы работы. Внутренние часы работы: общее время нахождения устройства во включенном состоянии. Внешние часы работы: общее время

предыдущих циклов центрифугирования. При остановленном роторе запрос может выполняться следующим образом. Процедуру можно прервать в любое время нажатием клавиши .



Нажмите и удерживайте клавишу в течение восьми секунд.



Удерживайте клавишу, пока не отобразится следующее.



Нажмите клавишу.
TimeExt (Внешнее время): внешние часы работы.

Пример



Нажмите клавишу.
TimeInt (Внутреннее время): внутренние часы работы.

Пример



Нажмите клавишу.
Starts (Запуски): Number количество всех циклов центрифугирования.

Пример



Нажмите клавишу дважды, чтобы выйти из меню "-> Time & Cycles" (Время и циклы), или нажмите трижды, чтобы выйти из меню "* MACHINE MENU *" (МЕНЮ УСТРОЙСТВА)..



Пример





14 СБОИ

Если неисправность не может быть устранена с помощью приведенной ниже таблицы неисправностей, обратитесь в службу поддержки клиентов и укажите тип центрифуги и серийный номер. Оба номера указаны на табличке с характеристиками центрифуги.



Выполните MAINS RESET (СБРОС ПИТАНИЯ): Выключите сетевой выключатель (положение выключателя «0»). Подождите по меньшей мере 10 секунд, а затем снова включите сетевой выключатель (положение выключателя «1»).

Сообщение/сбой	Причина	Устранение
Отсутствует отображение	Отсутствует напряжение. Неисправны входные предохранители.	<ul style="list-style-type: none"> – Проверьте распределение напряжения. – Проверьте сетевой предохранитель и обратитесь к инструкциям по замене сетевого предохранителя. – Сетевой выключатель в положении ВКЛ.

IMBALANCE (РАЗБАЛАНСИ РОВА)		Ротор загружен неравномерно.	<ul style="list-style-type: none"> – Откройте крышку после остановки ротора. – Проверьте загрузку ротора. – Повторите цикл центрифугирования.
MAINS INTER (СБОЙ ПИТАНИЯ)	11	Сбой питания во время цикла центрифугирования. (Цикл центрифугирования не был завершен.)	<ul style="list-style-type: none"> – Откройте крышку после остановки ротора. – Нажмите кнопку start/pause. – При необходимости повторите цикл центрифугирования.
MAINS INTERRUPT (СБОЙ ПИТАНИЯ)			
TACHO ERROR (ОШИБКА ТАХОГЕНЕРА ТОРА)	1, 2	Отказ скоростных импульсов во время работы..	<ul style="list-style-type: none"> – Выполните MAINS RESET при остановленном роторе. – Выполните MAINS RESET при остановленном роторе – Устройство нельзя выключить, пока на экране отображается вращающийся символ  Подождите, пока не появится символ  (крышка заблокирована)
LID ERROR (ОШИБКА КРЫШКИ)	4.1 – 4.127	Ошибка блокировки или закрытия крышки.	
OVER SPEED (ПРЕВЫШЕНИ Е СКОРОСТИ)	5	Слишком быстрое вращение.	
VERSION ERROR (ОШИБКА ВЕРСИИ)	12	Некорректное распознавание модели центрифуги. Ошибка/дефект электроники.	
UNDER SPEED (НЕДОСТАТО ЧНАЯ СКОРОСТЬ)	13	Слишком медленное вращение.	
CTRL ERROR (ОШИБКА CTRL)	22.1, 25.2	Ошибка/дефект электроники.	
CRC ERROR (ОШИБКА CRC)	27.1		
COM ERROR (ОШИБКА COM)	31 – 36		
FC ERROR (ОШИБКА FC)	60, 61.1 – 61.21, 61.64 – 61.142		
FC ERROR (ОШИБКА FC)	61.23		
TACHO ERR (ОШИБКА	61.22	Ошибка измерения скорости.	

ТАХОГЕНЕРАТОРА)			(приблизительно через 120 секунд). После этого проведите MAINS RESET.
FC ERROR (ОШИБКА FC)	61.153	Ошибка/дефект электроники	<ul style="list-style-type: none"> – Выполните MAINS RESET. – Проверьте загрузку ротора согласно предоставленным инструкциям.. – Повторите цикл центрифугирования.

15 ОТНОСИТЕЛЬНОЕ ЦЕНТРОБЕЖНОЕ УСКОРЕНИЕ (ОЦУ)

Относительное центробежное ускорение (ОЦУ) представляет собой величину, кратную ускорению силы тяжести (g). Это значение без единиц измерения и служит для сравнения эффективности разделения и оседания. Относительное центробежное ускорение (ОЦУ) зависит от количества оборотов в минуту и радиуса центрифугирования. Его можно рассчитать по формуле ниже:

$$RCF = \left(\frac{RPM}{1000} \right)^2 \times r \times 1,118 \quad \Rightarrow \quad RPM = \sqrt{\frac{RCF}{r \times 1,118}} \times 1000$$

RCF = относительное центробежное ускорение

RPM = скорость вращения (число оборотов в минуту)

r = радиус центрифугирования в мм = расстояние от центра оси вращения до нижней части контейнерацентрифуги.

16 ТРАНСПОРТИРОВКА И ХРАНЕНИЕ

Перед транспортировкой устройства следует установить крепежное устройство для транспортировки. Устройство и принадлежности можно хранить только в закрытых и сухих помещениях. При транспортировке или хранении устройства и аксессуаров должны соблюдаться следующие условия: Температура окружающей среды: от -20 до +60 °C.

Относительная влажность: от 10 до 80 %, без образования конденсата

17 ЗАМЕНА ВХОДНЫХ ПРЕДОХРАНИТЕЛЕЙ

Начните с выключения сетевого выключателя и отделения устройства от сети. Держатель предохранителя (A) с входными предохранителями находится рядом с сетевым выключателем. Выньте соединительный кабель из разъема устройства. Прижмите защелку (B) к держателю предохранителя (A) и выньте. Замените неисправные входные предохранители. Используйте только предохранители с номиналом, определенным для типа центрифуги, предоставленного производителем. Повторно вставьте держатель предохранителя до щелчка защелки. Повторно подсоедините устройство к сети питания.

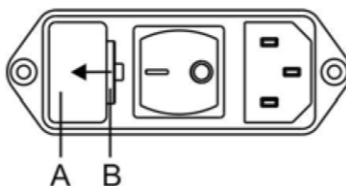

18 ВОЗВРАТ УСТРОЙСТВ

Перед возвратом устройства следует установить крепежное устройство для транспортировки. Если устройство или его принадлежности возвращаются в компанию Intra-Lock International, Inc., для защиты персонала, окружающей среды и материалов необходимо провести деконтаминацию и очистку перед отправкой. Законный производитель оставляет за собой право отказать в загрязненных устройствах или аксессуарах. Расходы на очистку и дезинфекцию оплачиваются заказчиком.

19 УТИЛИЗАЦИЯ

Перед утилизацией необходимо провести деконтаминацию и очистку устройства для защиты персонала, окружающей среды и имущества. При утилизации устройства необходимо соблюдать соответствующие предусмотренные законодательством правила. В соответствии с директивой 2002/96/EC (WEEE) все устройства, поставленные после 13 августа 2005 г., нельзя утилизировать как часть бытовых отходов. Устройство относится к группе 8 (медицинские устройства) и категории «для корпоративных клиентов». Значок перечеркнутого мусорного бака указывает на то, что устройство нельзя утилизировать как часть бытовых отходов. Рекомендации по утилизации отходов в отдельных странах могут отличаться. При необходимости обратитесь к поставщику.

ARCHIVED DOCUMENT



Die folgende Symboltabelle dient nur als Referenz. Die entsprechenden Symbole finden Sie auf dem Etikett der Produktverpackung.

Symbol	Symbol Beschreibung
	Achtung
	Elektronische Gebrauchsanleitung
	Hersteller
	BioHorizons Produkte tragen die CE-Kennzeichnung und erfüllen die Anforderungen der Medizinprodukte-Richtlinie 93/42/EWG
	Referenz-/Artikelnummer
	Los-/Chargennummer
	Nicht wiederverwenden
	Nicht erneut sterilisieren.
	Haltbarkeitsdatum
	Sterilisiert mittels Gammastrahlung
	Herstellungsdatum
	Achtung: Laut Bundesgesetz der USA darf dieses Produkt nur von einem Zahnarzt oder Arzt oder auf dessen Anordnung verkauft, vertrieben und verwendet werden

Symbol	Symbol Beschreibung
	Ausgangsposition
	Nicht verwenden, wenn die Verpackung beschädigt ist
	Medizinprodukt
	Nicht steril
	Trocken lagern
	Zerbrechlich; mit Vorsicht behandeln
	Temperaturgrenzen
	Diese Seite oben
	Feuchtigkeitsgrenzen
	Warnung; Biogefährdung
	Wichtige Hinweise
	Separate Sammlung von elektrischen und elektronischen Geräten.
	Bevollmächtigter Vertreter in der Europäischen Gemeinschaft

1 INDIKATIONEN

Das IntraSpin-System dient zur sicheren und schnellen Präparation von autologem plättchenreichem Fibrin (L-PRF) aus einer kleinen Blutprobe am Point-of-Care des Patienten. Das L-PRF wird vor der Anwendung an einem Knochendefekt mit Autotransplantat- und/oder Allotransplantatknochen gemischt, um die Handhabungseigenschaften zu verbessern. Das Beachten aller Informationen in der Gebrauchsanweisung ist ebenfalls Teil der beabsichtigten Verwendung.

2 KONTRAINDIKATIONEN

Die IntraSpin-Zentrifuge ist nur für den in der beabsichtigten Verwendung des Geräts angegebenen Zweck vorgesehen. Jede andere Verwendung des Geräts gilt als nicht beabsichtigt. Die Verwendung der IntraSpin-Zentrifuge ist bei Vorliegen einer oder mehrerer der folgenden klinischen Situationen kontraindiziert: Patienten mit Alkoholabhängigkeit oder psychiatrischen Störungen, Blutdyskrasien, unkontrolliertem Diabetes, Hyperthyreose, oralen Infektionen, bösartigen Erkrankungen oder Patienten mit Myokardinfarkt innerhalb der letzten 12 Monate. Patienten mit systemischen Erkrankungen, die das Immunsystem beeinträchtigen, wie AIDS, Patienten, die Medikamente einnehmen, die die Heilung einer Implantationsstelle beeinträchtigen würden, Patienten mit einer Vorgeschichte, in der die Mundhygiene schlecht oder nicht eingehalten wurde.

Patienten, die unter einer gerinnungshemmenden Therapie stehen. Diese Patienten sind nicht von den Vorteilen von PRF ausgeschlossen; allerdings ist mit einer Verzögerung des Bluttrennungsverfahrens zu rechnen und deshalb sollte mit zusätzlicher Zeit für die Zentrifugation gerechnet werden, um eine wirksame Trennung für die Anwendung zu erreichen.



3 HINWEISE ZUR SICHERHEIT

- Ein Gewährleistungsanspruch wird vom Hersteller nicht in Betracht gezogen, es sei denn, ALLE Anweisungen in diesem Handbuch wurden befolgt.
- Die Bedienungsanleitung ist Bestandteil des Geräts. Sie muss immer verfügbar sein. Wenn das Gerät an einem anderen Ort aufgestellt wird, muss die Bedienungsanleitung mitgeliefert werden.
- Die Zentrifuge sollte auf einer guten und stabilen Grundfläche installiert werden.
- Bevor Sie die Zentrifuge verwenden, überprüfen Sie unbedingt den Rotor auf einen festen Sitz.
- Wenn die Zentrifuge läuft, dürfen sich keine Personen, Gefahrstoffe oder Gegenstände innerhalb des Sicherheitsabstands von 300 mm um die Zentrifuge herum befinden.
- Rotoren, Aufhängungen und Zubehörteile, die Spuren von Korrosion oder mechanischen Beschädigungen aufweisen oder deren Nutzungsdauer abgelaufen ist, dürfen nicht mehr verwendet werden.
- Die Zentrifuge darf nicht mehr in Betrieb genommen werden, wenn die Zentrifugationskammer sicherheitsrelevante Schäden aufweist.
- Wenn bei Zentrifugen ohne Temperaturregelung die Raumtemperatur erhöht ist und/oder das Gerät häufig eingesetzt wird, könnte die Zentrifugationskammer erwärmt werden. Es kann daher nicht ausgeschlossen werden, dass sich das Probenmaterial aufgrund der Temperatur verändern könnte.
- Vor dem ersten Betrieb Ihrer Zentrifuge sollten Sie die Bedienungsanleitung lesen und beachten. Nur Personal, das die Bedienungsanleitung gelesen und verstanden hat, darf das Gerät bedienen.
- Neben der Bedienungsanleitung und den gesetzlichen Vorschriften zur Unfallverhütung sollten Sie auch die anerkannten Berufsordnungen für eine sichere und professionelle Arbeit befolgen. Diese Bedienungsanleitung sollte in Verbindung mit allen anderen Anweisungen zur Unfallverhütung und

zum Umweltschutz auf der Grundlage der nationalen Vorschriften des Landes, in dem das Gerät eingesetzt werden soll, gelesen werden.

- Die Erfüllung der länderspezifischen Anforderungen an den Arbeitsschutz im Hinblick auf die Nutzung von Zentrifugen an den dafür vorgesehenen Arbeitsplätzen liegt im Verantwortungsbereich des Nutzers.
- Diese Zentrifuge ist ein hochmodernes Gerät, das extrem sicher zu bedienen ist. Es kann jedoch zu Gefahren für Nutzer oder andere Personen kommen, wenn sie von nicht ausgebildetem Personal, in unangemessener Weise oder für einen anderen Zweck als den, für den sie konzipiert wurde, verwendet wird.
- Die Zentrifuge darf während des Betriebs nicht bewegt oder gestoßen werden.
- Berühren Sie im Fall eines Defekts oder einer Nothalt-Auslösung nie den Rotor, bevor dieser aufgehört hat, sich zu drehen.
- Um Schäden durch Kondensation zu vermeiden, muss sich die Zentrifuge beim Wechsel von einem kalten in einen warmen Raum entweder mindestens 3 Stunden im warmen Raum erwärmen, bevor sie mit dem Stromnetz verbunden werden kann, oder 30 Minuten im kalten Raum warm laufen.
- Während des Zentrifugierens mit den maximalen Umdrehungen pro Minute darf die Dichte der Materialien oder der Materialmischungen 1,2 kg/dm³ nicht überschreiten.
- Die Zentrifuge darf nur dann betrieben werden, wenn die Waage innerhalb der Grenzen der Akzeptanz liegt.
- Die Zentrifuge darf nicht in explosionsgefährdeten Bereichen betrieben werden.
- Die Zentrifuge darf nicht verwendet werden mit entzündbaren oder explosiven Materialien, die miteinander reagieren und viel Energie erzeugen.
- Für diese Zentrifuge sind keine Bio-Sicherheitssysteme verfügbar.
- Die Zentrifuge darf nicht mit hochkorrosiven Stoffen betrieben werden, die die mechanische Integrität von Rotoren, Aufhängungen und Zubehör beeinträchtigen könnten.
- Reparaturen dürfen nur von Mitarbeitern durchgeführt werden, die dafür vom Hersteller autorisiert sind.
- Um Patienten das höchste Niveau an klinischer Sicherheit zu bieten, werden IntraSpin-Produkte mit Materialien hergestellt, die biokompatibel mit menschlichem Plasma sind.
- Dieses Produkt ist nicht für den Verkauf in allen Ländern zugelassen und möglicherweise nicht in Ihrem Land erhältlich. Für weitere Informationen wenden Sie sich bitte an Ihren zuständigen IntraSpin-Vertreter.

4 INTRASPIN-SYSTEMKOMPONENTEN

KOMPONENTE	ANZAHL PRO SYSTEM
IntraSpin-Zentrifuge einschließlich:	1
Stromkabel	1
Sicherung	2
Sechskantschlüssel	1
Greiner Blutentnahmeröhrchen und Ausgleichsröhrchen (Einmalgebrauch).	150
Greiner Safety Blutentnahmeset + Halter, 21G (Einmalgebrauch)	24
Latexfreies Tourniquet	1
Teströhrchenständer	1

Chirurgisch gebogene Schere	1
Chirurgische Gewebezange	1
Runde Edelstahlschale	1
Rechteckige Edelstahlschale	1
Dualer Spatel zur Biomaterialapplikation	1
Dualer Biomaterialstopfer	1
Xpression® Box	1

Es werden nur geprüfte kompatible Komponenten für die direkte Verwendung mit der IntraSpin-Zentrifuge empfohlen und garantiert:

KOMPATIBLES TEIL #	BESCHREIBUNG
455092	Tube 9ml CAT Serum Clot Activator, rote Kappe
455001	Weißer Kappe 9 ml Z Keine Zusatzröhrchen
BHEXZ (E613)	IntraSpin-Inbusschlüssel, 110 V und 220 V.
BROTORZ (E3694)	IntraSpin-Rotor, 110 V und 220 V.
BPOWER110Z (E1673)	IntraSpin-Netz kabel, 110 V.
BPOWER220Z (E1669)	IntraSpin-Netz kabel, 220 V.
BTUBEHOLDZ (E872 x 1)	IntraSpin-Ersatz-Röhrchenhalter
BFUSE110Z (E997)	IntraSpin-Sicherung 110v
BFUSE220Z (E891)	IntraSpin-Sicherung 220v

5 KURZANLEITUNG ZENTRIFUGEN-EINRICHTUNG

Entfernen Sie die Transportschrauben vom Boden der Zentrifuge und bewahren Sie sie auf.

Schließen Sie das Netzkabel an und stecken Sie es in die Steckdose.

Schalten Sie die Zentrifuge mit dem Wippschalter auf der Rückseite des Geräts ein.

Wählen Sie Drehzahl und Zeit: Drehzahl = 2700 & Zeit = 12:00 min.

Auf START drücken.

Der Zentrifugendeckel öffnet sich automatisch am Ende jedes Zyklus.

Nach dem ersten Zentrifugenlauf werden Zeiteinstellung und Drehzahl im Speicher der Zentrifuge aufgezeichnet, es sei denn, die Einstellungen werden geändert.

6 VORSICHTSHINWEISE UND ANWEISUNGEN FÜR BLUTENTNAHMERÖHRCHEN UND BLUTENTNAHMESETS

- Keine Röhrchen verwenden, an denen Fremdpartikel vorhanden sind.
- Die Blutentnahmeröhrchen müssen sich vollständig füllen lassen.
- Behandeln Sie alle biologischen Proben und „scharfen Gegenstände“ zur Blutentnahme (z. B. Nadeln und Blutentnahmesets) gemäß den Richtlinien und Verfahren Ihrer Einrichtung.
- Die Nadel nicht biegen.
- Den Nadelsicherheitsmechanismus nicht gewaltsam loslassen und nicht erneut aktivieren, nachdem er aktiviert wurde.
- Bei Exposition gegenüber biologischen Proben (z. B. durch Stichverletzung) aufgrund der möglichen Übertragung von HIV (AIDS), Virushepatitis oder anderen Infektionskrankheiten angemessene medizinische Hilfe in Anspruch nehmen.

- Entsorgen Sie alle Instrumente für die Blutentnahme in zugelassenen Behältern für biogefährdende Materialien.
- Das Übertragen einer Probe von einer Spritze in ein Röhrchen wird nicht empfohlen.
- Wenn Blut über eine intravenöse (IV) Leitung entnommen wird, befolgen Sie die Richtlinien und Verfahren Ihrer Einrichtung, um sicherzustellen, dass die IV-Lösung aus der Leitung vollständig herausgespült wurde, bevor Sie mit dem Befüllen der Blutentnahmeröhrchen beginnen.
- Das Blutgerinnungsbeschleunigungsmittel kann auf der Röhrchenoberfläche weiß erscheinen, was keinen Einfluss auf die Leistung der Röhrchen hat. Wenn andere Verfärbungen oder Niederschläge im Röhrchen vorhanden sind, sollte es nicht verwendet werden.
- Verwenden Sie die Röhrchen nicht nach dem Verfallsdatum.
- Blutentnahmeröhrchen bei 4–25 °C (40–77 °F) lagern.
- Das Blutabnahmeset (Nadel und Halter) bei 4–36 °C (40–97 °F) lagern.
- Vermeiden Sie direkte Sonneneinstrahlung. Das Überschreiten der maximal empfohlenen Lagertemperatur kann zu einer Beeinträchtigung der Röhrchenqualität führen (d. h. Vakuumverlust, Färbung usw.).
- Um einen Rückfluss zu verhindern, bringen Sie den Arm des Patienten in eine nach unten gerichtete Stellung, halten Sie den Schlauch mit der Kappe nach oben und lösen Sie das Tourniquet, sobald Blut in den Schlauch fließt. Vermeiden Sie, dass der Schlauchinhalt während der Venenpunktion mit der Kappe oder dem Kanülenende in Kontakt kommt.
- Stellen Sie sicher, dass die folgenden Materialien leicht zugänglich sind, bevor Sie eine Venenpunktion durchführen: alle erforderlichen Blutentnahmeröhrchen, gekennzeichnete Etiketten zur positiven Identifizierung von Patientenproben, Blutentnahmekanülen und -halter, Alkoholtupfer zur Reinigung der Einstichstelle, saubere Gaze, Tourniquet, Heftpflaster oder Verband, zugelassener Behälter für biogefährdende Materialien. Zum Schutz vor der Exposition gegenüber durch Blut übertragenen Krankheitserregern wird eine geeignete PSA (persönliche Schutzausrüstung) empfohlen (z. B. Handschuhe, Laborkittel, Schutzbrille usw.).

Venenpunktionstechnik und Blutprobenentnahme:

Die Blutentnahme muss so schnell wie möglich erfolgen, da sich in den Entnahmeröhrchen kein Antikoagulans befindet. Die Blutprobe beginnt sofort zu gerinnen. Tragen Sie während der Venenpunktion und beim Umgang mit Blutentnahmeröhrchen Handschuhe, um die Expositionsgefahr zu minimieren. Wischen Sie vor der Blutentnahme die Oberseite der Blutentnahmeröhrchen mit einem Desinfektionstuch Ihrer Wahl ab. Entfernen Sie die Abdeckung über dem Ventilabschnitt der Kanüle. Bereiten Sie die Venenpunktionsstelle mit einem geeigneten Antiseptikum vor. Venenpunktionsbereich nach der Reinigung nicht abtasten. Bringen Sie den Arm des Patienten in eine nach unten gerichtete Stellung. Entfernen Sie den Kanülenschutz. Führen Sie die Venenpunktion mit dem Arm nach unten und der Blutentnahmeröhrchen nach oben durch. Stabilisieren Sie die Nadel bei Bedarf mit Klebeband. Schieben Sie das Blutentnahmeröhrchen in den Halter und auf das Kanülenventil, das die Gummimembran des Blutentnahmeröhrchens durchstößt. Zentrieren Sie die Blutentnahmeröhrchen im Halter, wenn Sie mit der Kanüle die Kappe durchdringen, um ein Eindringen in die Seitenwand und einen anschließenden vorzeitigen Vakuumverlust zu verhindern. Entfernen Sie das Tourniquet, sobald Blut im Blutentnahmeröhrchen erscheint. Halten Sie das Entnahmeröhrchen während des Eingriffs immer mit einem Daumen fest. Dies stellt eine vollständig vakuumgetriebene Entnahme sicher. Das Blutentnahmeröhrchen füllt sich automatisch. Wenn kein Blut in das Sammelröhrchen fließt oder wenn der Blutfluss vor der Entnahme eines geeigneten Probenvolumens aufhört, werden die folgenden Schritte vorgeschlagen, um eine zufriedenstellende Entnahme abzuschließen:

- Schieben Sie das Blutentnahmeröhrchen nach vorne, um sicherzustellen, dass die Kappe durchgedrungen ist.
- Überprüfen Sie die korrekte Position der Kanüle in der Vene.
- Wenn immer noch kein Blut fließt, entfernen Sie das Entnahmeröhrchen und entsorgen Sie es entsprechend. Nehmen Sie ein neues Entnahmeröhrchen und drücken Sie es in den Halter.
- Wenn auch das zweite Entnahmeröhrchen nicht zieht, entfernen Sie die Kanüle und das Entnahmeröhrchen und entsorgen Sie sie entsprechend. Wiederholen Sie den gesamten Entnahmevergung.
- Wenn das maximale Volumen in Höhe der Fülllinie des Blutentnahmeröhrchens erreicht ist, nehmen Sie es vorsichtig aus dem Halter. Wiederholen Sie den Entnahmevergung mit einem zweiten Blutentnahmeröhrchen.

Drehen Sie jedes Entnahmeröhrchen sofort nach dem Entfernen aus dem Halter vorsichtig um. Schütteln Sie die mit Blutproben gefüllten Röhrchen nicht. Kräftiges Mischen kann Schaumbildung oder Hämolyse verursachen. Unzureichendes Mischen oder verzögertes Mischen in Serumröhrchen kann zu einer verzögerten Gerinnung führen.

Entfernen Sie die Nadel nach Abschluss der Blutprobenentnahme aus der Vene. Aktivieren Sie den Sicherheitsmechanismus (Schutzschild) der Nadel, indem Sie die Nabe auf beiden Seiten eindrücken, um die Verriegelung zu aktivieren. Schieben Sie den Sicherheitsmechanismus nach hinten, bis er hörbar einrastet. Verschließen Sie die Nadel nicht wieder, da dies das Risiko von Nadelstichverletzungen und Blutexposition erhöht. Entsorgen Sie die gebrauchte Nadel mit dem Halter in einem geeigneten Entsorgungsbehälter für biologisches Gefahrgut. Falls gewünscht, einen Verband anlegen, sobald eine Gerinnung aufgetreten ist. Es wird empfohlen, gefüllte Entnahmeröhrchen aufrecht zu halten. Sobald das zweite Röhrchen voll ist, wird es abgenommen und das erste und zweite Röhrchen werden in der Zentrifuge gegenüberliegend eingesetzt, um den Rotor auszubalancieren. Den Deckel der IntraSpin® Zentrifuge schließen und auf die START-Taste drücken, um für 12 MINUTEN zu zentrifugieren.

Wenn mehr als zwei Röhrchen Blut benötigt werden, bitte dieses alternative Verfahren befolgen: Nachdem die ersten beiden Röhrchen mit Blut entnommen und vorsichtig umgedreht wurden, müssen diese sofort in die IntraSpin Zentrifuge einander gegenüberliegend positioniert werden, um zu gewährleisten, dass die Zentrifuge ordnungsgemäß ausbalanciert ist. Schließen Sie den Deckel, drücken Sie die START-Taste und lassen Sie die Zentrifuge laufen, während Sie mit den weiteren Röhrchen die Blutentnahme fortsetzen. Drücken Sie die STOP-Taste und lassen Sie die Zentrifuge zum Stillstand kommen. Der Deckel öffnet sich; stellen Sie die weiteren Röhrchen sofort in gegenüberliegenden Positionen in die Zentrifuge, um ein korrektes Gleichgewicht zu gewährleisten. Drücken Sie dann die START-Taste, um das empfohlene Protokoll zurückzusetzen und abzuschließen.

Die Röhrchen immer paarweise und in gegenüberliegenden Positionen einsetzen, um den Rotor der Zentrifuge auszubalancieren. Die Röhrchen müssen stets im Rotor ausbalanciert sein, bevor auf die START-Taste gedrückt wird, ansonsten kann es zu schweren Schäden an der Zentrifuge, unangemessener Koagulation und/oder Trennung kommen. Wenn die Röhrchen nicht richtig ausbalanciert sind, treten während der Zentrifugation zu viele Vibrationen auf und es entsteht ein schlechtes L-PRF-Fibringerinnsel.

Wenn eine ungerade Anzahl von Blutproben zentrifugiert werden soll, muss ein Ausgleichsröhrchen mit weißer Kappe (z. B. 455001), das bis zur angezeigten Markierung mit Wasser gefüllt ist, gegenüber dem

nicht gepaarten Röhrchen in den Rotor positioniert werden. Dadurch kann die Zentrifuge richtig ausbalanciert werden.

Die Zentrifugation sofort nach Entnahme der Blutproben beginnen. Verzögerungen beeinflussen das Bluttrennungsverfahren und führen zu einem schlechten L-PRF-Fibringerinnsel.

7 PRÄPARATION DES L-PRF

Nach der Zentrifugation sind drei Fraktion sichtbar:

1. Obere Fraktion = thrombozytenarmes Plasma (PPP).
2. Mittlere Fraktion = Fibringerinnsel: L-PRF.
3. Untere Fraktion = Erythrozyten-Blutgerinnsel.

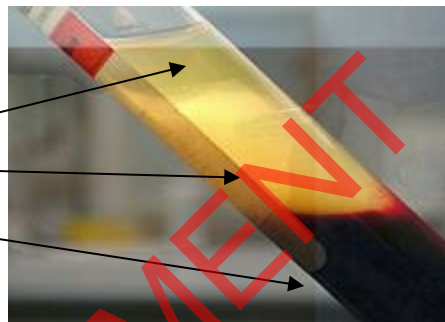

L-PRF-Fibrinmembranen oder -stopfen müssen relativ schnell hergestellt werden: 0 bis 15 Minuten nach der Zentrifugation, ansonsten schrumpft das Gerinnsel volumemäßig, da das eingeschlossene Serum freigesetzt wird. Nach der Zentrifugation den Gummistopfen von jedem Röhrchen abnehmen. Entfernen Sie mit der chirurgischen Gewebezange das L-PRF-Gerinnsel aus dem Röhrchen. Kratzen Sie das Gerinnsel der roten Blutkörperchen vorsichtig mit der Biomaterial-Doppelträger-Spatel vom L-PRF-Fibringerinnsel direkt unterhalb der Vereinigungsstelle ab, sodass nur eine minimale Restmenge an roten Blutkörperchen an das L-PRF-Gerinnsel haften bleiben. Legen Sie das Fibringerinnsel auf das Xpression Perforated Tray.

8 PRÄPARATION DER FIBRINMATRIX

Protokoll Nr. 1 – L-PRF Membran

Legen Sie jedes der Fibringerinnsel auf das perforierte Tablett (Xpression Perforated Tray). Sobald alle Fibringerinnsel platziert sind, platzieren Sie die Kompressionsplatte (Xpression Compression Plate) und die gewichtete Abdeckung (Xpression Weighted Cover) über den Fibringerinnseln, ohne Druck auf die Gerinnsel auszuüben.

Lassen Sie das Gewicht der Abdeckung das Fibringerinnsel langsam nach unten drücken, während das Exsudat auf den Boden des Tablett gefiltert wird. Keinen Druck auf die gewichtete Abdeckung ausüben. Die Schwerkraft auf der gewichteten Abdeckung komprimiert das Gerinnsel vorsichtig und drückt das Serum aus dem PRF-Gerinnsel aus, ohne das Fibrinnetz zu beschädigen.

Warten Sie mindestens 5 Minuten, bevor Sie Fibrinmembranen entfernen und verwenden. Eine Fibrinmembran darf erst direkt vor dem tatsächlichen Zeitpunkt der Verwendung entnommen werden. Die Fibrinmembran kann bis zu 3 Stunden in der Xpression Box verbleiben.



Protokoll Nr. 2 – L-PRF-Stopfen

Legen Sie ein Fibringerinnsel in den weißen Zylinder zur Herstellung eines Stopfens. Drücken Sie mit dem Kolben langsam auf das Gerinnsel im weißen Zylinder zur Herstellung eines L-PRF-Stopfens. Drücken Sie weiter, bis die Oberkante des Kolbens bündig mit der Oberkante des weißen L-PRF-Stopfenherstellungszylinders ist. Mit dieser Technik kann ein dicker, runder Fibrinstopfen für die Extraktionsvakuole gebildet werden. Für einen einzelnen Zahn kann ein L-PRF® Stopfen ausreichend sein. Für Prämolaren werden möglicherweise zwei L-PRF® Stopfen benötigt und je nach Größe der Extraktionsalveole und der Größe des erzeugten Fibringerinnsels können drei L-PRF® Stopfen für Molaren benötigt werden.

Die Verarbeitungseigenschaften von L-PRF® bieten ein ausgezeichnetes Medium für die Verwendung in Kombination mit dem Biomaterial Ihrer Wahl. Bei Verwendung eines der folgenden Mischprotokolle wird das Biomaterial in der Fibrinmatrix festgehalten, wodurch sich die Handhabung und biologische Kapazität verbessern.

Protokoll Nr. 3 – Biomaterial/L-PRF-Mischung

Um eine „spachtelartige“ Mischung herzustellen, die mit dem Biomaterial-Instrument vorsichtig in die gewünschte Form und Dicke geformt werden kann, das folgende Protokoll verwenden: Schneiden Sie die L-PRF-Fibrinmembran vorsichtig mit der gebogenen Chirurgeschere (Surgical Curved Scissors) in einer sterilen Schale in kleine Stücke. Die gewünschte Menge Knochentransplantatmaterial hinzufügen. L-PRF® und Knochentransplantatmaterial gründlich durchmischen. Diese Mischung kann mit dem Doppelträger-Spatel (Dual Biomaterial Carrier Spatula) in Defekte gebracht werden.

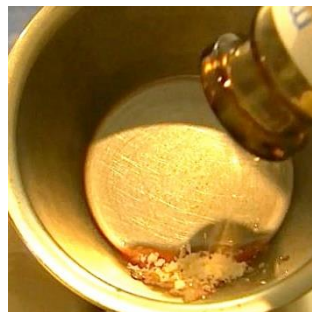

Protokoll Nr. 4 – Biomaterial/L-PRF-Matrixmischung

Die vorgegebene Menge an Knochentransplantatmaterial in eine sterile Schüssel oder Schale geben. Die ausgedrückte L-PRF® Membran oder Teile der L-PRF® Membran in das Transplantatmaterial eintauchen und dabei die gesamte Oberfläche der L-PRF® Membran mit Transplantatmaterial abdecken. Alternativ kann das Transplantatmaterial auf die L-PRF® Membran gesprenkelt und die gesamte Oberfläche mit Transplantatmaterial bedeckt werden. Hinweis: Auf einer feuchteren L-PRF® Membran kann etwas mehr Transplantatmaterial haften bleiben als auf einer trockeneren PRF-Membran. Das Transplantatmaterial sollte an der Oberfläche des L-PRF® anhaften; falls gewünscht, kann das Transplantatmaterial jedoch vorsichtig auf die L-PRF® Membran gedrückt werden. Die chirurgische Gewebepinzette (Surgical Tissue Forceps) kann verwendet werden, um diese Mischung in den Defekt einzubringen.

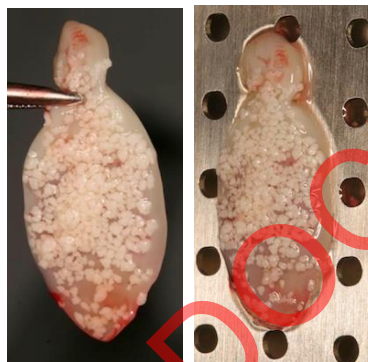

Protokoll Nr. 5 – Biomaterialhydratation

Geben Sie die gewünschte Menge Knochentransplantatmaterial in eine sterile Schüssel oder Schale. Verwenden Sie das Exsudat vom Boden des Xpression Collection Tray, um das Transplantatmaterial zu hydratisieren. Das Exsudat und das Knochentransplantatmaterial gründlich mischen. Diese Mischung kann mit dem Dual Biomaterial Carrier Spatula in Defekte eingebracht werden.



9 REINIGUNG UND STERILISIERUNG DES GEWEBEREGENERATIONS-KITS

Die Xpression® Box ermöglicht die einfache Herstellung von Fibrinmembranen mit konstanter Dicke. Das Exsudat kann aus der Xpression-Sammelschale (Xpression Collection Tray) unter dem perforierten Xpression-Tablett (Xpression Perforated Tray) entnommen werden. Die Xpression Box enthält Zylinder zur

Herstellung von L-PRF-Stopfen und einen Kolben zur Herstellung von L-PRF-Stopfen, die problemlos in Extraktionsvakuolen passen.



Xpression Gewichtete Abdeckung

Xpression Kompressionsplatte

Xpression Perforiertes Tablett in der Xpression Sammelschale

Die Xpression Box und die Zusatzinstrumente werden NICHT steril geliefert. Entfernen und entsorgen Sie das Versandmaterial vor der ersten Sterilisation. Reinigen und sterilisieren Sie die Xpression Box und die Zusatzinstrumente vor jedem Gebrauch.

Zerlegen Sie die Xpression Box vor jedem Reinigungs- und Sterilisationszyklus in ihre Komponenten, um die Einkapselung von Schmutz, Materialverfärbungen und/oder unzureichende Trocknung der Komponenten zu vermeiden. Die Zylinder zur Herstellung des L-PRF-Stopfens und die Kolbentülle dürfen nicht zur Reinigung und Sterilisation aus dem Xpression Perforated Tray entfernt werden.

Reinigung: 1.) Entfernen Sie sichtbare Rückstände von den Xpression Box-Komponenten und Zusatzinstrumenten mit einer weichen Bürste und einem Breitband-Reinigungs- oder Desinfektionsmittel wie Hu-Friedys Enzymax® oder einem gleichwertigen Mittel. Gut nachspülen. 2.) Legen Sie die Xpression Box-Komponenten und Zusatzinstrumente in einen entsprechend großen Behälter mit derselben Lösung und beschallen Sie sie für 10 Minuten im Ultraschallbad. Gut nachspülen. 3.) Spülen Sie die Komponenten und Zusatzinstrumente der Xpression Box mit Isopropylalkohol, um Seifenreste und Mineralien zu entfernen. 4.) Tupfen Sie die Xpression Box-Komponenten und Zusatzinstrumente mit einem fusselfreien Handtuch ab und trocknen Sie sie vollständig an der Luft. Anweisungen zur Verwendung finden Sie auf der Kennzeichnung des verwendeten Reinigungsmittels.

Sterilisation: 1.) Legen Sie die wieder zusammengebaute Xpression Box und die Zusatzinstrumente in einen von der FDA zugelassenen Sterilisationsbeutel oder eine Verpackung. 2.) Führen Sie einen der folgenden qualifizierten Sterilisationszyklen durch:

Sterilisationsmethode	Temperatur	Expositionszeit	Minimale Trocknungszeit
Dampfsterilisation mit Vorvakuum (ANSI/AAMI ST79)	132 °C (270 °F)	4 min	20–30 Minuten
Dampfsterilisation mit Vorvakuum (UK DoH Health Technical Memorandum 01-01)	134 °C (273 °F)	3 min	20–30 Minuten

Achtung! Eine unsachgemäße Reinigung kann zu einer unzureichenden Sterilisation führen. Wenn die Xpression Box-Komponenten und Zusatzinstrumente während des Autoklavierens nicht vollständig getrocknet werden, kann Feuchtigkeit zurückbleiben und Verfärbungen und Oxidation verursachen. Die Verwendung von Wasserstoffperoxid oder anderen Oxidationsmitteln beschädigt die Oberfläche der Xpression Box-Komponenten und Zusatzinstrumente. Es wird empfohlen, die Autoklavenausrüstung regelmäßig zu testen, zu reinigen und zu kalibrieren, um sicherzustellen, dass das Gerät in einwandfreiem Zustand bleibt.

10 ZENTRIFUGE – REINIGUNG

Das Gerät kann verunreinigt sein. Ziehen Sie den Netzstecker vor der Reinigung. Zentrifugen, Rotoren und Zubehör dürfen nicht in Spülmaschinen gereinigt werden. Sie dürfen nur von Hand gereinigt und mit Flüssigkeiten desinfiziert werden. Die Wassertemperatur muss zwischen 20 °C und 25 °C liegen. Es dürfen nur Reinigungs-/Desinfektionsmittel mit einem pH-Wert zwischen 5 und 8 verwendet werden, die keine ätzenden Laugen, Peroxide, Chlorverbindungen, Säuren und alkalischen Lösungen enthalten. Um Korrosion durch Reinigungsmittel oder Desinfektionsmittel zu verhindern, ist die Anwendungsanweisung des Reinigungsmittel- oder Desinfektionsmittelherstellers unbedingt zu beachten.

Reinigen Sie das Zentrifugegehäuse und die Zentrifugationskammer regelmäßig mit Seife oder einem milden Reinigungsmittel und einem feuchten Tuch, um Korrosion durch anhaftende Verunreinigungen zu vermeiden. Bestandteile geeigneter Reinigungsmittel umfassen Seife, anionische Tenside und nichtionische Tenside. Entfernen Sie nach der Verwendung von Reinigungsmitteln alle Rückstände des Reinigungsmittels, indem Sie sie mit einem feuchten Tuch abwischen. Die Oberflächen müssen sofort nach der Reinigung getrocknet werden. Trocknen Sie bei Kondenswasserbildung die Zentrifugationskammer durch Auswischen mit einem saugfähigen Tuch. Reiben Sie die Gummidichtung der Zentrifugenkammer nach jeder Reinigung leicht mit Talkpulver oder einem Gummipflegemittel ein. Die Zentrifugationskammer ist auf Beschädigungen zu prüfen. Bei sicherheitsrelevanten Schäden darf die Zentrifuge nicht mehr in Betrieb genommen werden. Informieren Sie in diesem Fall den Kundendienst.

Zur Flächendesinfektion, wenn infektiöse Stoffe in die Zentrifugalkammer eindringen, ist diese sofort zu desinfizieren. Bestandteile geeigneter Desinfektionsmittel umfassen Ethanol, n-Propanol, Ethylhexanol, anionische Tenside und Korrosionsinhibitoren. Entfernen Sie nach der Verwendung von Desinfektionsmitteln Rückstände des Desinfektionsmittels, indem Sie diese mit einem feuchten Tuch abwischen. Die Oberflächen müssen sofort nach der Desinfektion getrocknet werden.

Zur Entfernung radioaktiver Verunreinigungen muss das Mittel ausdrücklich als Mittel zur Entfernung radioaktiver Verunreinigungen gekennzeichnet sein. Bestandteile geeigneter Mittel zum Entfernen radioaktiver Verunreinigungen umfassen anionische Tenside, nichtionische Tenside, polyhydratisiertes Ethanol. Entfernen Sie nach dem Entfernen der radioaktiven Verunreinigungen die Wirkstoffreste, indem Sie sie mit einem feuchten Tuch abwischen. Die Oberflächen müssen direkt nach dem Entfernen der radioaktiven Verunreinigungen getrocknet werden.

11 ROTOR UND ZUBEHÖR – REINIGUNG UND INSTANDHALTUNG

Um Korrosion und Materialveränderungen zu vermeiden, müssen Rotor und Zubehör regelmäßig mit Seife oder einem milden Reinigungsmittel und einem feuchten Tuch gereinigt werden. Die Reinigung wird mindestens einmal pro Woche empfohlen. Verunreinigungen müssen sofort entfernt werden.

Bestandteile geeigneter Waschmittel umfassen Seife, anionische Tenside und nichtionische Tenside. Entfernen Sie nach der Verwendung von Reinigungsmitteln alle Rückstände des Reinigungsmittels, indem Sie sie mit Wasser abspülen (nur außerhalb der Zentrifuge) oder sie mit einem feuchten Tuch abwischen. Rotor und Zubehör müssen unmittelbar nach der Reinigung getrocknet werden. Überprüfen Sie den Rotor und das Zubehör wöchentlich auf Verschleiß- und Korrosionsschäden. Rotor und Zubehör dürfen nicht mehr verwendet werden, wenn sie Verschleißerscheinungen oder Korrosion aufweisen. Überprüfen Sie wöchentlich den festen Sitz des Rotors. Sollte infiziertes Material auf den Rotor oder das Zubehör gelangen, müssen diese entsprechend desinfiziert werden.

Bestandteile geeigneter Desinfektionsmittel umfassen Ethanol, n-Propanol, Ethylhexanol, anionische Tenside und Korrosionsinhibitoren. Entfernen Sie nach der Verwendung von Desinfektionsmitteln Rückstände des Desinfektionsmittels, indem Sie sie mit Wasser abspülen (nur außerhalb der Zentrifuge) oder sie mit einem feuchten Tuch abwischen. Rotor und Zubehör müssen direkt nach der Desinfektion getrocknet werden.

Zur Entfernung radioaktiver Verunreinigungen muss das Mittel ausdrücklich zur Entfernung radioaktiver Verunreinigungen gekennzeichnet sein. Bestandteile geeigneter Mittel zum Entfernen radioaktiver Verunreinigungen umfassen anionische Tenside, nichtionische Tenside und polyhydratisiertes Ethanol. Entfernen Sie nach dem Entfernen der radioaktiven Verunreinigungen die Wirkstoffreste, indem Sie sie mit Wasser abspülen (nur außerhalb der Zentrifuge) oder mit einem feuchten Tuch abwischen. Der Rotor und das Zubehör müssen direkt nach dem Entfernen der radioaktiven Verunreinigungen getrocknet werden.

Der Rotor kann 20 Minuten lang bei 121 C / 250 F autoklaviert und entsprechend getrocknet werden. Nach 10 Autoklavierungszyklen muss der Rotor aus Sicherheitsgründen ausgetauscht werden. Autoklavieren beschleunigt den Alterungsprozess von Kunststoffen und kann zu Verfärbungen führen. Warten Sie nach dem Autoklavieren, bis der Rotor auf Umgebungstemperatur abgekühlt ist, bevor Sie ihn wieder verwenden. Über den Grad der Sterilität kann keine Aussage getroffen werden.

Die Nutzungsdauer des Rotors ist auf 50.000 Laufzyklen (Zentrifugationsläufe) oder 5 Jahre begrenzt, je nachdem, was zuerst eintritt. Auf dem Rotor ist die maximal zulässige Anzahl an Laufzyklen zu sehen. Aus Sicherheitsgründen darf der Rotor nicht mehr verwendet werden, wenn die maximal zulässige Anzahl von Laufzyklen (auf ihm markiert) erreicht ist. Das Gerät ist mit einem Zykluszähler ausgestattet, der die durchgeführten Laufzyklen (Zentrifugationsläufe) anzeigt.

Bei einem Bruch eines Blutprobenröhrchens sind alle gebrochenen Teile und das Blut vollständig zu entfernen. Die Zentrifuge ist wie angegeben gründlich zu reinigen und Gummieinsätze sowie Kunststoffhülsen des Rotors sind auszutauschen.

12 TECHNISCHE DATEN FÜR ZENTRIFUGE

Modelltyp	IS220Z	IS110Z
Netzspannung ($\pm 10\%$)	200–240 V 1~	100–127 V 1~

Netzfrequenz	50–60 Hz-	50–60 Hz
Anschlussleistung	100 VA	100 VA
Stromaufnahme	0,5 A	1,0 A
Kapazität	8 x 10 ml	
Maximal zulässige Dichte	1,2 kg/dm ³	
Maximale Drehzahl (RPM)	6.000 U/min	
Kraft (RCF)	3.461	
Kinetische Energie	750 Nm	
Aufstellstandort	Nur im Innenbereich	
Höhe	Bis zu 2000 m über Meeresspiegel	
Umgebungstemperatur für den Betrieb	5°C bis 40°C	
Luftfeuchtigkeit für den Betrieb	Die maximale, relative Luftfeuchtigkeit liegt bei 80% bei Temperaturen bis 31°C und verringert sich linear auf 50% relative Luftfeuchtigkeit bei 40°C.	
Überspannungskategorie	II	
Verschmutzungsgrad	2	
Geräteschutzklasse	I	
	Nicht geeignet für den Einsatz in explosionsgefährdeten Bereichen.	
Störaussendung, Störsicherheit	EN / IEC 61326-1, Klasse B	FCC-Klasse B
Geräuschpegel (je nach Rotor)	≤50 dB(A)	
Breite der Zentrifuge	261 mm	
Tiefe der Zentrifuge	353 mm	
Höhe der Zentrifuge	228 mm	
Gewicht der Zentrifuge	ca. 9 kg	

13 BETRIEBSANLEITUNG ZENTRIFUGE

Die Transportsicherungsvorrichtung, bestehend aus 2 Schrauben (a) und 2 Abstandshaltern (b), muss unbedingt entfernt werden. Verahren Sie die Transportsicherungsvorrichtung an einer sicheren Stelle, da sie erneut installiert werden muss, bevor das Gerät transportiert wird. Das Gerät darf nur mit der installierten Transportsicherungsvorrichtung transportiert werden. Um das Gerät vor Beschädigungen während des Transports zu schützen, wird der Motor fixiert. Diese Transportsicherungsvorrichtung muss bei Inbetriebnahme des Geräts entfernt werden.

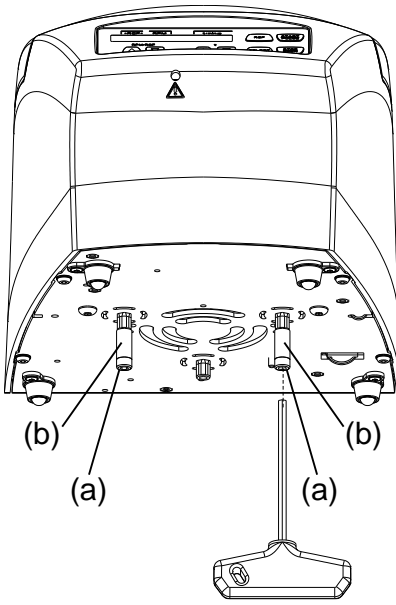

13.1 ERSTE INBETRIEBNAHME

- Entfernen Sie die Transportsicherungsvorrichtung von der Unterseite der Zentrifuge.
- Positionieren Sie die Zentrifuge stabil und ebenerdig an einem geeigneten Ort. Wenn die Zentrifuge läuft, dürfen sich keine Personen, Gefahrstoffe oder Gegenstände innerhalb des Sicherheitsabstands von 300 mm um die Zentrifuge herum befinden.
- Lüftungsöffnungen dürfen nicht blockiert sein. Ein Abstand von 300 mm von den Lüftungsschlitzen und Öffnungen der Zentrifuge muss eingehalten werden.
- Prüfen Sie, ob die Netzspannung mit der Angabe auf dem Typenschild übereinstimmt.
- Verbinden Sie die Zentrifuge mit dem Stromkabel an eine Standard-Netzsteckdose.
- Schalten Sie den Netzschalter ein.
- Die folgenden Anzeigen werden auf dem Bedienfeld angezeigt: der Zentrifugenmodelltyp, die Softwareversion und die zuletzt verwendeten Zentrifugationsdaten.
- Wenn der Deckel geschlossen ist, wird die Meldung „Open the lid“ (Deckel öffnen) angezeigt. Öffnen Sie in diesem Fall den Deckel, um die Zentrifugationsdaten anzuzeigen.

13.2 ÖFFNEN UND SCHLIESSEN DES ZENTRIFUGENDECKELS

Der Deckel kann nur geöffnet werden, wenn die Zentrifuge eingeschaltet ist und sich der Rotor nicht bewegt. Wenn der Zykluszähler nach einem Zentrifugationslauf aktiviert wird, wird beim Öffnen des Deckels die verbleibende Anzahl der Laufzyklen (Zentrifugationsläufe) kurz angezeigt.

Beispiel:



Drücken Sie die folgende Taste, um den Deckel zu öffnen. Der Deckel wird durch den Motor entriegelt.  zeigt an, dass der Deckel entriegelt ist.



Beispiel:

Greifen Sie nicht mit den Fingern zwischen Deckel und Gehäuse. Schlagen Sie den Deckel nicht zu.

Drücken Sie zum Schließen des Deckels leicht auf die Vorderkante des Deckels.  zeigt an, dass der Deckel verriegelt ist.



Beispiel:

13.3 NOTENTRIEGELUNG

Bei einem Stromausfall kann der Deckel nicht mit dem Motor entriegelt werden. Die Notentriegelung muss per Hand erfolgen. Um im Notfall zu entriegeln, schalten Sie den Netzschalter aus (Schalteneinstellung „0“). Sehen Sie durch das Fenster im Deckel, um zu überprüfen, ob der Rotor stillsteht. Öffnen Sie den Deckel nur, wenn der Rotor stillsteht. Fügen Sie den Sechskantschlüssel horizontal in die Bohrung (A) ein und drehen Sie diesen vorsichtig gegen den Uhrzeigersinn (nach links), bis sich der Deckel öffnet. VORSICHT! Durch Drehen des Inbusschlüssels im Uhrzeigersinn (nach rechts) kann das Verriegelungssystem beschädigt werden. Ziehen Sie den Sechskantschlüssel aus der Bohrung zurück.

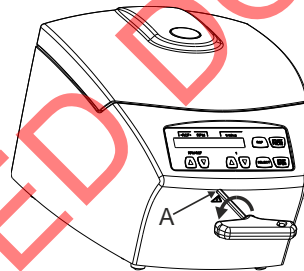

13.4 INSTALLATION UND ENTFERNUNG DES ROTORS

Rotor entfernen: Lösen Sie die Spannmutter des Rotors, indem Sie sie mit dem Sechskantschlüssel (im Lieferumfang enthalten) gegen den Uhrzeigersinn drehen und zum Hubdruckpunkt aufdrehen. Nach Überwindung des Hebedruckpunktes wird der Rotor aus dem Konus der Motorwelle gelöst. Drehen Sie die Spannmutter so lange, bis der Rotor von der Motorwelle gehoben werden kann. Heben Sie den Rotor von der Motorwelle ab.

Rotor einbauen: Reinigen Sie die Motorwelle (A) und das Bohrloch des Rotors und tragen Sie dann eine dünne Fettschicht auf die Motorwelle auf. Schmutzpartikel zwischen Motorwelle und Rotor verhindern, dass der Rotor perfekt sitzt, und lassen ihn unruhig laufen. Setzen Sie den Rotor senkrecht auf die Motorwelle. Beim Aufsetzen des Rotors muss der Markierungsbalken (B) auf dem Rotor parallel zu beiden Oberflächen (C) auf der Motorwelle sein. Ziehen Sie die Spannmutter des Rotors mit dem Sechskantschlüssel (im Lieferumfang enthalten) durch Drehen im Uhrzeigersinn fest. Überprüfen Sie den Rotor, um sicherzustellen, dass er fest sitzt.

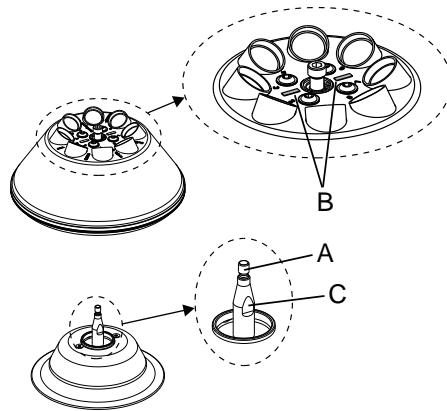

Die Rotoren müssen symmetrisch beladen werden. Die Blutprobenröhrchen müssen gleichmäßig auf alle Rotorpositionen verteilt sein.

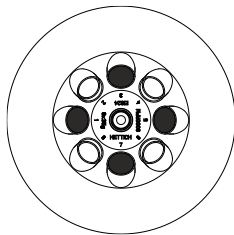

Rotor ist gleichmäßig beladen

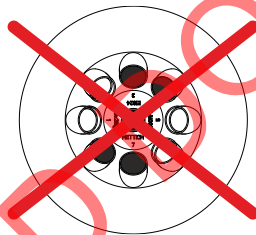

Rotor ist nicht gleichmäßig beladen

Nicht erlaubt!

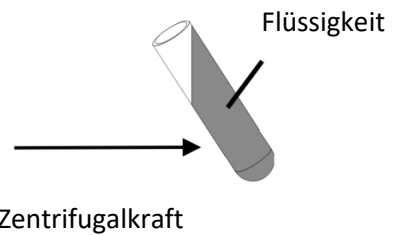

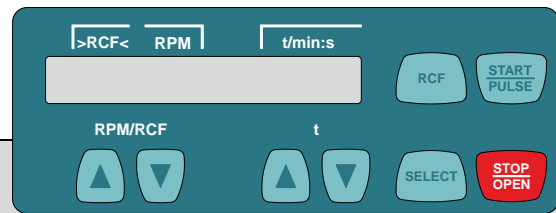

Die Blutröhrchen dürfen nur außerhalb der Zentrifuge gefüllt werden. Die maximale Füllmenge für die Blutröhrchen ist auf den Röhrchen selbst angegeben und darf das auf dem Rotor angegebene Maximalgewicht nicht überschreiten. Die Zentrifugenbehälter dürfen nur so weit befüllt werden, dass keine Flüssigkeit aus ihnen austreten kann, während die Zentrifuge betrieben wird. Beim Beladen des Rotors darf keine Flüssigkeit in den Rotor oder in die Zentrifugationskammer gelangen. Um die Gewichtsunterschiede innerhalb des Zentrifugenbehälters so gering wie möglich zu halten, wird ein gleichmäßiger Füllstand in den Blutröhrchen empfohlen.

13.5 BESCHREIBUNG DER ANZEIGEELEMENTE



Symbol / Bedienfeldschlüssel	Beschreibung
	Deckel entriegelt.
	Deckel verriegelt.
	Rotationsanzeige. Die Rotationsanzeige leuchtet auf und dreht sich im Uhrzeigersinn, wenn sich der Rotor dreht.
	Geben Sie die Drehzahl direkt ein. Wenn die Taste gedrückt gehalten wird, ändert sich der Wert mit zunehmender Schnelligkeit.
	Geben Sie die Laufzeit direkt ein. Einstellbar in Schritten von 1 Sekunde bis zu einer Minute und in Schritten von 1 Minute ab 1 Minute. Geben Sie die Zentrifugationsparameter ein. Wenn die Taste gedrückt gehalten wird, ändert sich der Wert mit zunehmender Schnelligkeit.
	Einzelne Parameter aktivieren. Jedes Mal, wenn die Taste gedrückt wird, wird der nächste Parameter aktiviert. Halten Sie die Taste 8 Sekunden lang gedrückt, um das „MACHINE MENU“ (Gerätemenü) aufzurufen. Wählen Sie im „Machine Menu“ die Menüs „-> Info“, „-> Settings“ (Einstellungen) und „->Time & Cycles“ (Zeit und Zyklen) aus. Scrollen Sie in den Menüs nach vorn.
	Umschalten zwischen der Drehzahlanzeige (RPM) und der Anzeige der relativen Zentrifugalkraft (>RCF<). RCF-Werte werden zwischen den Pfeilen angezeigt ><.
	Starten Sie den Zentrifugationslauf. Für kurzfristige Zentrifugation: Zentrifugation wird ausgeführt, solange die Taste gedrückt wird. Auswählen der Menüs „-> Info“, „-> Settings“ und „-> Time & Cycles“.
	Beenden Sie den Zentrifugationslauf. Der Rotor läuft mit einer vorausgewählten Bremsstufe aus. Doppeltes Drücken der Taste löst den Nothalt aus. Entsperren Sie den Deckel.
t/min	Laufzeit. Einstellbar von 1–99 min in Schritten von 1 Minute.
t/sec	Laufzeit. Einstellbar von 1–59 s in Schritten von 1 Sekunde. Dauerlauf „-:-“. Stellen Sie die Parameter t/min und t/sec auf null ein.
RPM	Drehzahl. Ein Zahlenwert von 200 U/min kann bis zur Höchstdrehzahl des Rotors eingestellt werden. Einstellbar in 10er-Schritten.
>RCF<	Relative Zentrifugalkraft. Es kann ein Zahlenwert eingestellt werden, der eine Drehzahl zwischen 200 U/min und der maximalen Rotordrehzahl ergibt. Einstellbar in 1er-Schritten. Es ist nur möglich, die relative Zentrifugalkraft (RCF) einzugeben, wenn das RCF-Display (>RCF<) aktiviert ist. Die relative Zentrifugalkraft (RCF) hängt vom Zentrifugationsradius (RAD) ab. Nach Zugriff auf RCF sollten Sie darauf achten, dass der richtige Zentrifugationsradius eingestellt ist.
RAD/mm	Zentrifugationsradius. Einstellbar von 10 mm bis 250 mm in 1-mm-Schritten. Es ist nur möglich, den Zentrifugationsradius einzugeben, wenn das RCF-Display (RCF) aktiviert wird.
~_DEC	Bremsstufe. „fast“ (schnell) = kurze Auslaufzeit, „slow“ (langsam) = lange Auslaufzeit.



13.6 DIREKTE EINGABE DER ZENTRIFUGATIONSPARAMETER

Die Drehzahl (RPM), die relative Zentrifugalkraft (RCF), der Zentrifugationsradius (RAD) und die Laufzeit können direkt über die Tasten   eingegeben werden, ohne zuvor die  Taste zu verwenden. Die eingestellten Zentrifugationsparameter werden erst nach dem Start des Zentrifugationslaufs gespeichert.

Für Drehzahl (U/min):

 Drücken Sie die Taste, um das RPM-Display (U/min) nach Bedarf zu aktivieren.

RPM/RCF Stellen Sie mit den Tasten den gewünschten Wert ein.



 





Für relative Zentrifugalkraft (RCF) und Zentrifugationsradius (RAD):

 Drücken Sie nach Bedarf die Taste, um das RCF-Display (>RCF<) zu aktivieren.

RPM/RCF Stellen Sie den gewünschten RCF-Wert mit den Tasten ein.

t Stellen Sie den gewünschten Zentrifugationsradius bei Bedarf über die Tasten ein.



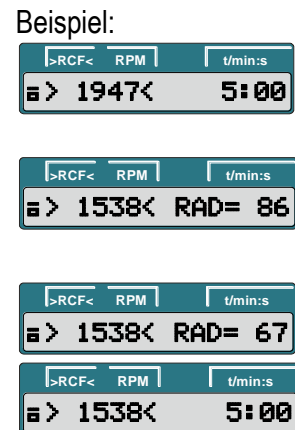

Laufzeit:

Bis zu einer Zeit von 1 Minute kann die Laufzeit in Schritten von 1 Sekunde eingestellt werden. Ab 1 Minute Gesamtzeit kann sie nur in Schritten von 1 Minute eingestellt werden. Um einen kontinuierlichen Lauf einzustellen, müssen die Parameter **t/min** und **t/sec** auf null gesetzt werden. In der Zeitanzeige erscheint (t/min:s), ":-:--".



t Stellen Sie mit den Tasten den gewünschten Wert ein.





13.7 EINGABE DER ZENTRIFUGATIONSPARAMETER ÜBER DIE TASTE „SELECT“ (AUSWÄHLEN)

Die Laufzeit kann in Minuten und Sekunden eingestellt werden (Parameter **t/min** und **t/sec**). Um einen kontinuierlichen Lauf einzustellen, müssen die Parameter **t/min** und **t/sec** auf null gesetzt werden. In der Zeitanzeige erscheint (t/min:s), „--:--“.



Beispiel:

Die relative Zentrifugalkraft (RCF) hängt vom Zentrifugationsradius (RAD) ab. Während der Eingabe der RCF wird der eingestellte Zentrifugationsradius angezeigt. Wenn nach der Auswahl oder während der Parametereingabe 8 Sekunden lang keine Taste gedrückt wird, werden die vorherigen Werte auf dem Display angezeigt. Die Parameter müssen dann wieder eingegeben werden. Durch Drücken der  Taste werden die Einstellungen gespeichert. Wenn mehrere Parameter eingegeben werden, muss die  Taste nach Einstellung des letzten Parameters gedrückt werden. Die Eingabe von Parametern kann jederzeit mit der  Taste abgebrochen werden. In diesem Fall werden die Einstellungen nicht gespeichert.

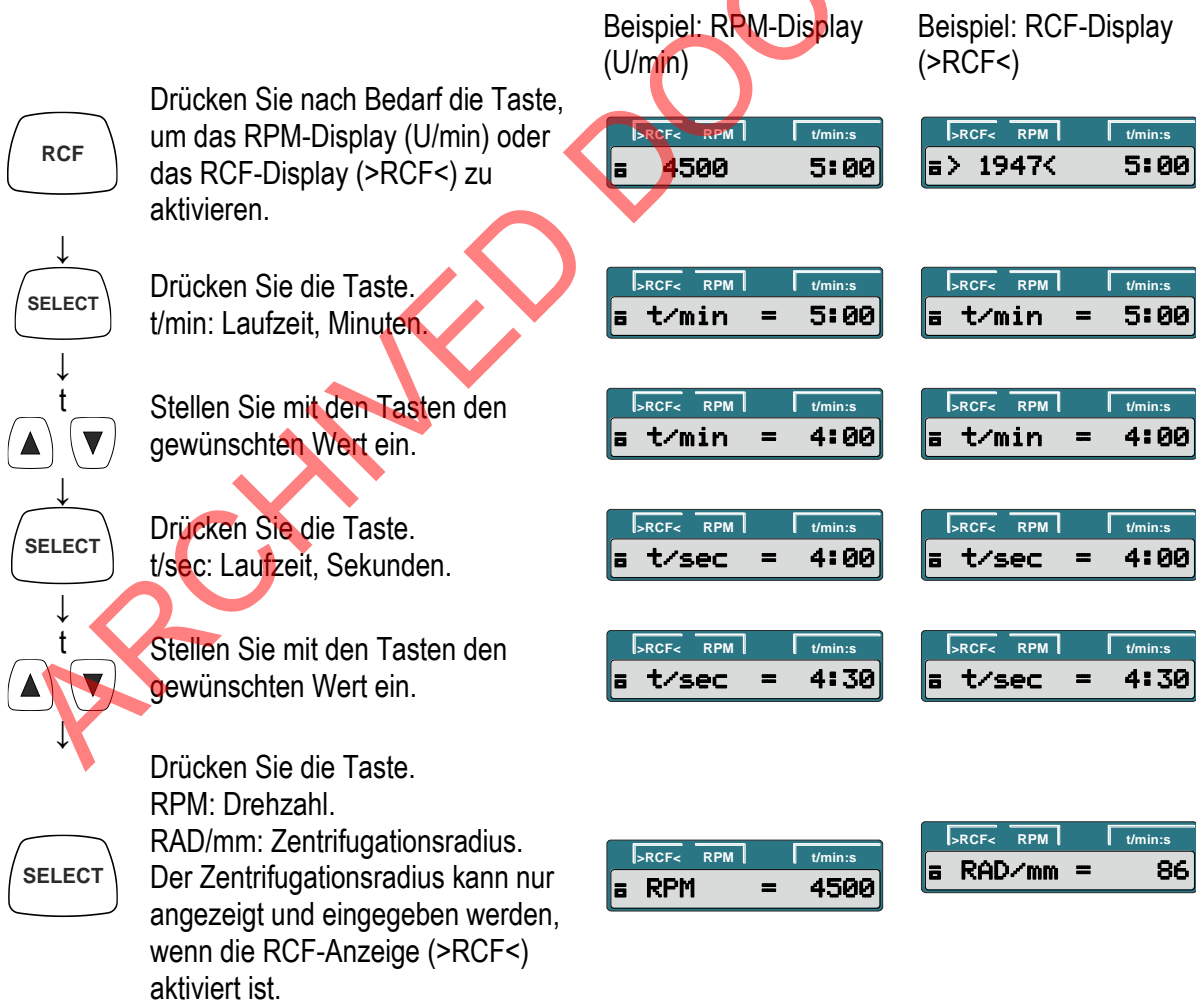

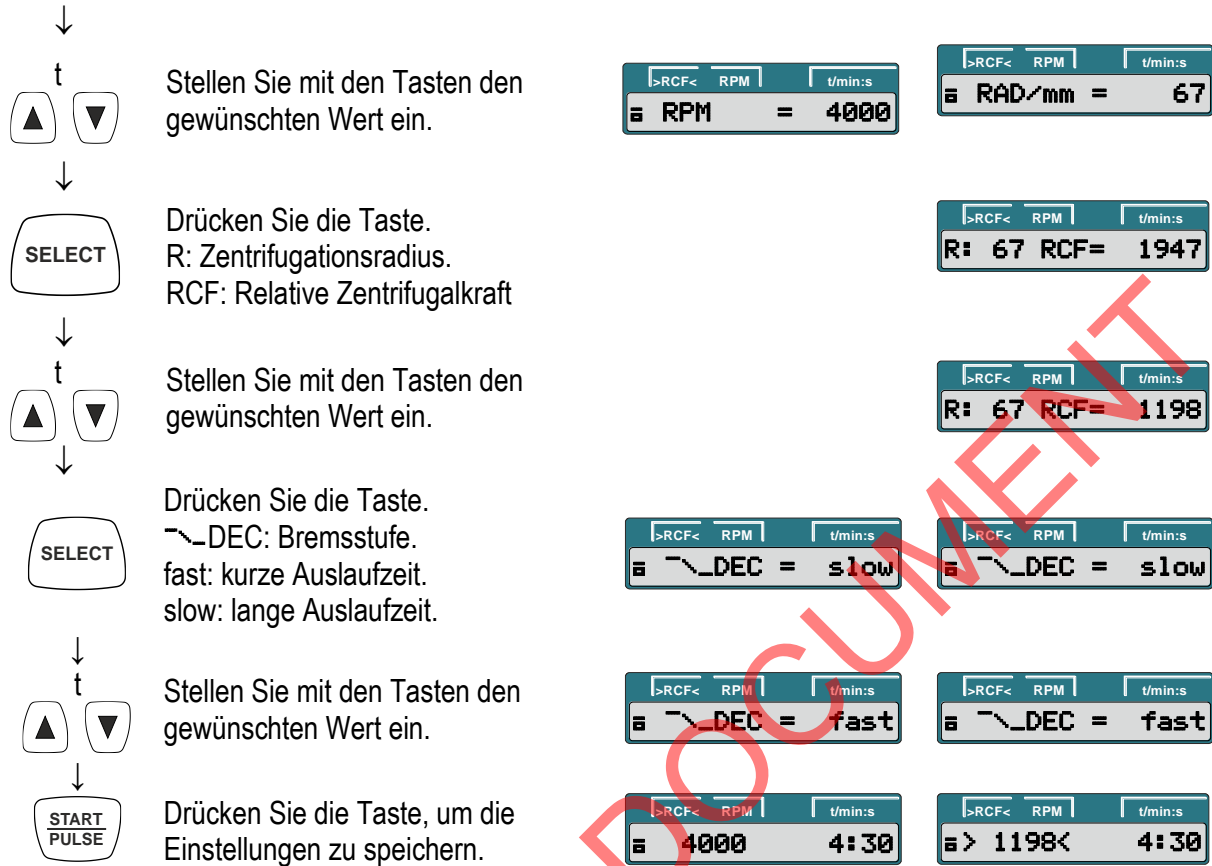

13.8 ANZEIGE DES BEDIENFELDS

Nach jedem Zentrifugationslauf und während der Deckel entriegelt wird, wird die restliche Anzahl an Laufzyklen (Zentrifugationsläufe) kurz angezeigt.

Beispiel:

Bei Überschreitung der zulässigen Gewichtsabweichung innerhalb der Rotorlast wird der Zentrifugationslauf beim Startvorgang abgebrochen und „IMBALANCE“ wird angezeigt.

Beispiel:

Ein Zentrifugationslauf kann jederzeit abgebrochen werden, indem man die Taste drückt. Während eines Zentrifugationslaufs können die Zentrifugationsparameter ausgewählt und geändert werden. Die geänderten Werte gelten aber nur für den aktuellen Zentrifugationslauf und werden nicht gespeichert. Mit der

Taste, können Sie zwischen dem RPM-Display (RPM) und dem RCF-Display (>RCF<) jederzeit wechseln. Wenn mit dem RCF-Display (>RCF<) gearbeitet wird, muss der Zentrifugationsradius eingegeben

werden. Ein weiterer Betrieb der Zentrifuge ist dann erst nach dem Öffnen des Deckels möglich. Betriebsfehler und Fehlfunktionen werden angezeigt.

Beispiel: 

13.9 ZENTRIFUGATION MIT VORGEGEBENER ZEIT

 Drücken Sie nach Bedarf die Taste, um das RPM-Display (U/min) oder das RCF-Display (>RCF<) zu aktivieren.

↓
Geben Sie die gewünschten Zentrifugationsparameter ein.

↓
 Drücken Sie die Taste, um den Zentrifugationslauf zu starten. Während des Zentrifugationslaufs werden die Rotordrehzahl oder der daraus resultierende RCF-Wert und die verbleibende Zeit angezeigt.

↓
Nach Ablauf der Zeit oder nach Abbrechen des Zentrifugationslaufs durch Drücken der  Taste erfolgt der Auslaufvorgang mit der eingestellten Bremsstufe. Die Bremsstufe wird angezeigt \sim -f.

Beispiel:
RPM-Display (U/min)











Beispiel:
RCF-Display (>RCF<)











13.10 DAUERLAUF

 Drücken Sie nach Bedarf die Taste, um das RPM-Display (U/min) oder das RCF-Display (>RCF<) zu aktivieren.

↓
Geben Sie die gewünschten Zentrifugationsparameter ein. Stellen Sie die Parameter t/min und t/sec auf null ein

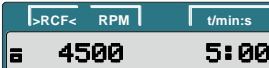
Beispiel:
RPM-Display (U/min)





Beispiel:
RCF-Display (>RCF<)







Drücken Sie die Taste, um den Zentrifugationslauf zu starten. Während des Zentrifugationslaufs werden die Rotordrehzahl oder der daraus resultierende RCF-Wert und die verbleibende Zeit angezeigt.



Drücken Sie die Taste, um den Zentrifugationslauf zu beenden. Der Auslaufvorgang erfolgt mit der eingestellten Bremsstufe. Die Bremsstufe wird angezeigt ~\f.

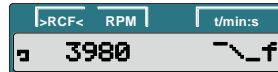

13.11 KURZFRISTIGE ZENTRIFUGATION



Drücken Sie nach Bedarf die Taste, um das RPM-Display (U/min) oder das RCF-Display (>RCF<) zu aktivieren.

Beispiel:
RPM-Display (U/min)

Beispiel:
RCF-Display (>RCF<)

Geben Sie die gewünschten Zentrifugationsparameter ein.



Drücken und halten Sie die Taste gedrückt. Während des Zentrifugationslaufs werden die Rotordrehzahl oder der daraus resultierende RCF-Wert und die vergangene Zeit angezeigt.

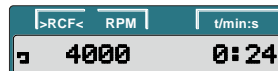

Lassen Sie die Taste wieder los, um den Zentrifugationslauf zu beenden. Der Auslaufvorgang erfolgt mit der eingestellten Bremsstufe. Die Bremsstufe wird angezeigt ~\f.

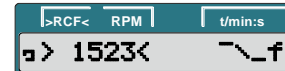
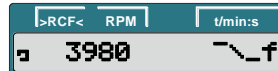

13.12 NOTHALT



Drücken Sie die Taste zweimal. Während des Nothalts erfolgt der Auslauf mit der Bremsstufe „fast“ (schnell; kurze Auslaufzeit). Die Bremsstufe ~\f wird angezeigt.

Beispiel:
RPM-Display (U/min)

Beispiel:
RCF-Display (>RCF<)

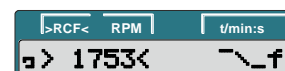

13.13 ZYKLUSZÄHLER

Die Zentrifuge ist mit einem Zykluszähler ausgestattet, der die Laufzyklen (Zentrifugationsläufe) zählt. Nach jedem Zentrifugationslauf und während der Deckel entriegelt wird, wird die restliche Anzahl an Laufzyklen (Zentrifugationsläufe) kurz angezeigt.



Beispiel:

Bei Überschreitung der maximal zulässigen Anzahl an Rotorlaufzyklen wird bei jedem Start des Zentrifugationslaufs Folgendes angezeigt, siehe nachfolgendes Beispiel. Der Zentrifugationslauf muss dann erneut gestartet werden. Der Rotor muss aus Sicherheitsgründen sofort gegen einen neuen Rotor ausgetauscht werden. Nachdem der Rotor ausgetauscht wurde, muss der Zykluszähler auf „0“ zurückgesetzt werden.



Beispiel:

13.14 SO SETZEN SIE DEN ZYKLUSZÄHLER AUF NULL ZURÜCK

Nachdem der Rotor ausgetauscht wurde, muss der Zykluszähler wieder auf null gesetzt werden. Der Zykluszähler darf nur dann auf null zurückgesetzt werden, wenn der Rotor zunächst gegen einen neuen Rotor ausgetauscht wurde. Wenn der Motor stillsteht, kann der Zykluszähler wie folgt zurückgesetzt werden.

Der Vorgang kann jederzeit durch Drücken der  Taste abgebrochen werden. In diesem Fall werden die Einstellungen nicht gespeichert.

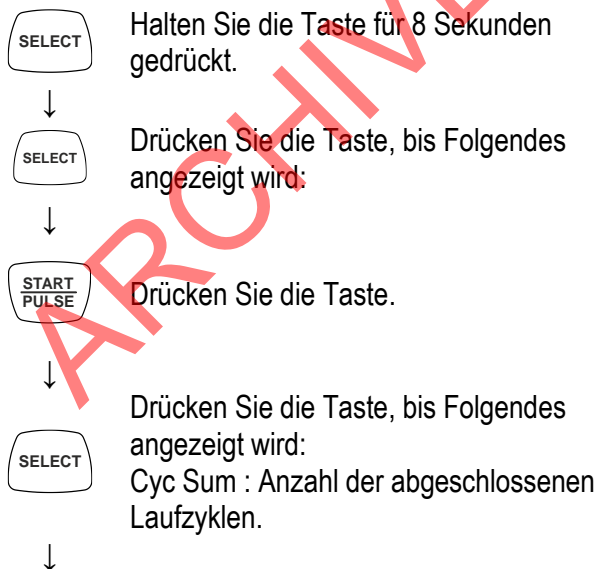

Beispiel:





Drücken Sie die Taste.



t



Drücken Sie die Taste.
Die Anzahl der abgeschlossenen Laufzyklen wird auf null zurückgesetzt.



Drücken Sie die Taste, um die Einstellung zu speichern.



Drücken Sie Taste zweimal, um das Menü „ -> Time & Cycles“ (Zeit und Zyklen) zu verlassen, oder drücken Sie sie dreimal, um das „* MACHINE MENU *(Gerätemenü) zu verlassen.



Beispiel:



13.15 EINSTELLUNGEN UND ABFRAGEN

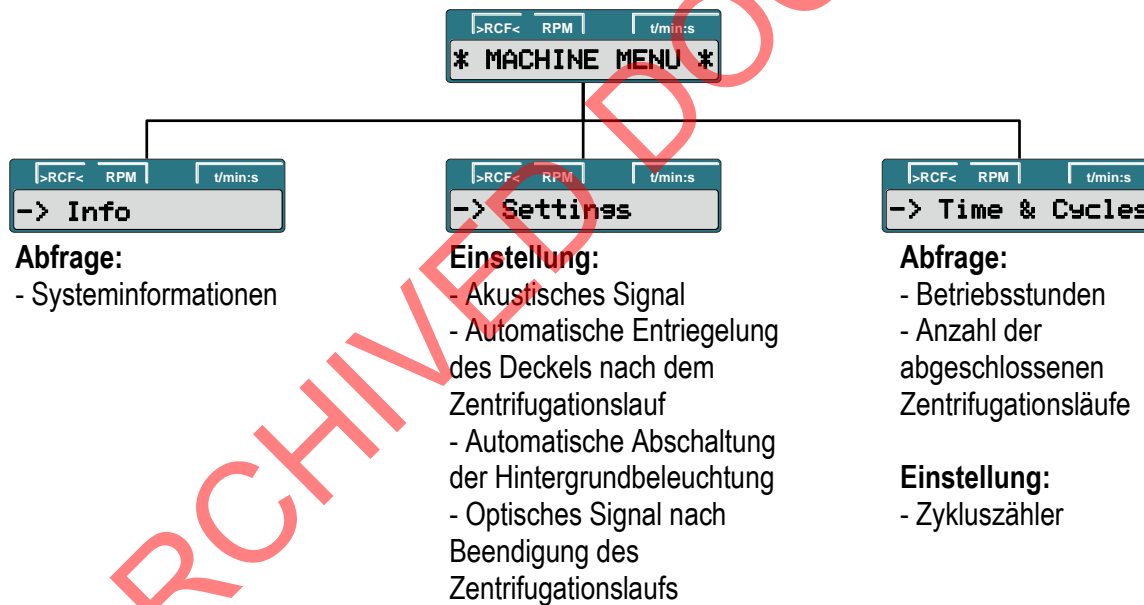

13.16 ABFRAGE DER SYSTEMINFORMATIONEN

Folgende Systeminformationen können abgefragt werden:

- Gerätemodell
- Programmversion des Geräts
- Typennummer des Geräts
- Herstellungsdatum des Geräts
- Geräte-Seriennummer
- Frequenzwandlertyp

- Frequenzwandler-Programmversion

Bei Stillstand des Rotors kann die Abfrage wie folgt durchgeführt werden: Der Vorgang kann jederzeit durch Drücken der  Taste abgebrochen werden.

 Halten Sie die Taste für 8 Sekunden gedrückt.



↓
 Drücken Sie die Taste.



↓
 Drücken Sie die Taste.
Gerätemodell.

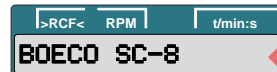

↓
 Drücken Sie die Taste.
Programmversion des Geräts.

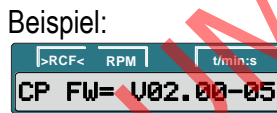

↓
 Drücken Sie die Taste.
Type#1 (Typ 1) : Typennummer des Geräts.



↓
 Drücken Sie die Taste.
Type#2 (Typ 2): Fortsetzung der Typennummer, wenn diese mehr Positionen hat als das „Type#1“-Anzeigenfeld.



↓
 Drücken Sie die Taste.
Herstellungsdatum des Geräts.



↓
 Drücken Sie die Taste.
Geräte-Seriennummer.

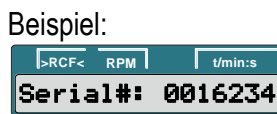

↓
 Drücken Sie die Taste.
Frequenzwandler typ.

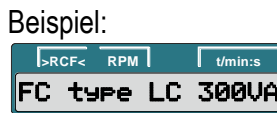

↓
 Drücken Sie die Taste.
Frequenzwandler-Programmversion.

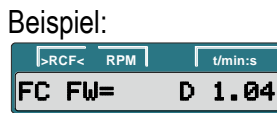



Drücken Sie die Taste zweimal, um das „-> Info“-Menü zu verlassen, oder drücken Sie sie dreimal, um das „* MACHINE MENU *“ (Gerätemenü) zu verlassen.



Beispiel:

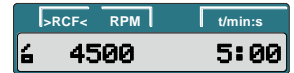

13.17 AKUSTISCHES SIGNAL

Das akustische Signal ertönt: 1.) nach einer Störung in einem 2-Sekunden-Intervall; 2.) nach Beendigung des Zentrifugationslaufs und nach Stillstand des Rotors in einem 30-Sekunden-Intervall. Das akustische Signal wird durch Drücken einer beliebigen Taste beendet. Steht der Rotor still, kann das akustische Signal

wie folgt eingestellt werden. Der Vorgang kann jederzeit durch Drücken der  Taste abgebrochen werden. In diesem Fall werden die Einstellungen nicht gespeichert.



Halten Sie die Taste für 8 Sekunden gedrückt.



Drücken Sie die Taste, bis Folgendes angezeigt wird:

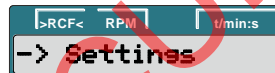

Drücken Sie die Taste.

End beep (Piepton Ende): Akustisches Signal nach Beendigung des Zentrifugationslaufs.



off (aus): Signal deaktiviert.
on (ein): Signal aktiviert.



Stellen Sie über die Tasten **off** oder **on** ein.



Drücken Sie die Taste.

Error beep (Piepton Fehler): Akustisches Signal nach einer Störung.



off: Signal deaktiviert.
on: Signal aktiviert.



Stellen Sie über die Tasten **off** oder **on** ein.



Drücken Sie die Taste.

Beep volume (Piepton Lautstärke):



Lautstärke des akustischen Signals.

min: leise
mid: mittel
max: laut



↓
 t
 ▲ ▼
 Stellen Sie mit den Tasten **min**, **mid** oder **max** ein.



↓
 START PULSE
 Drücken Sie die Taste, um die Einstellung zu speichern.

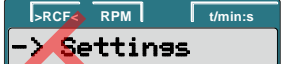

↓
 STOP OPEN
 Drücken Sie die Taste einmal, um das Menü „-> Settings“ (Einstellungen) zu verlassen, oder zweimal, um das „* MACHINE MENU *“ (Gerätemenü) zu verlassen.

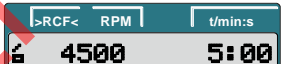

Beispiel:

13.18 OPTISCHES SIGNAL NACH BEENDIGUNG DES ZENTRIFUGATIONSLAUFS

Die Hintergrundbeleuchtung des Displays blinkt nach der Zentrifugation, um visuell zu signalisieren, dass der Zentrifugationslauf beendet ist. Das optische Signal kann bei Stillstand des Rotors ein- oder ausgeschaltet werden. Der Vorgang kann jederzeit durch Drücken der  Taste abgebrochen werden.

SELECT
 Halten Sie die Taste für 8 Sekunden gedrückt.



↓
 SELECT
 Drücken Sie die Taste, bis Folgendes angezeigt wird:



↓
 START PULSE
 Drücken Sie die Taste.



↓
 Drücken Sie die Taste, bis eine der folgenden Anzeigen erscheint.
End blinking (Blinken nach Ende):
 Hintergrundbeleuchtung des Displays blinkt nach dem Zentrifugationslauf.
off (aus): Hintergrundbeleuchtung blinkt nicht.
on (ein): Hintergrundbeleuchtung blinkt.

SELECT



↓
 t
 ▲ ▼
 Stellen Sie über die Tasten **off** oder **on** ein.





Drücken Sie die Taste, um die Einstellung zu speichern.



Drücken Sie die Taste einmal, um das Menü „-> Settings“ (Einstellungen) zu verlassen, oder zweimal, um das „* MACHINE MENU *“ (Gerätemenü) zu verlassen.



Beispiel:



13.19 AUTOMATISCHE ENTRIEGELUNG DES DECKELS NACH DEM ZENTRIFUGATIONS-LAUF

Es kann eingestellt werden, ob der Deckel nach dem Zentrifugationslauf automatisch entriegelt wird oder nicht. Wenn der Rotor stillsteht, kann dies wie folgt eingestellt werden. Der Vorgang kann jederzeit durch Drücken der  Taste abgebrochen werden. In diesem Fall werden die Einstellungen nicht gespeichert.



Halten Sie die Taste für 8 Sekunden gedrückt.



Drücken Sie die Taste, bis Folgendes angezeigt wird:



Drücken Sie die Taste.



Drücken Sie die Taste, bis eine der folgenden Anzeigen erscheint.

Lid AutoOpen (Deckel autom. öffnen):
Automatische Entriegelung des Deckels nach dem Zentrifugationslauf.

off (aus): Deckel entriegelt nicht automatisch.

on (ein): Deckel entriegelt automatisch.

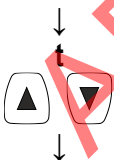

Stellen Sie über die Tasten **off** oder **on** ein.



Drücken Sie die Taste, um die Einstellung zu speichern.

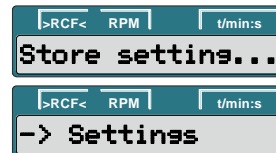



Drücken Sie die Taste einmal, um das Menü „-> Settings“ (Einstellungen) zu verlassen, oder zweimal, um das „* MACHINE MENU *“ (Gerätemenü) zu verlassen.



Beispiel:



13.20 HINTERGRUNDBELEUCHTUNG DES DISPLAYS

Um Energie zu sparen, kann eingestellt werden, dass nach einem Zentrifugationslauf die Hintergrundbeleuchtung des Displays nach 2 Minuten ausgeschaltet wird. Wenn der Rotor stillsteht, kann dies wie folgt eingestellt werden. Der Vorgang kann jederzeit durch Drücken der  Taste abgebrochen werden. In diesem Fall werden die Einstellungen nicht gespeichert.



Halten Sie die Taste für 8 Sekunden gedrückt.



Drücken Sie die Taste, bis Folgendes angezeigt wird:



Drücken Sie die Taste.



Drücken Sie die Taste, bis eine der folgenden Anzeigen erscheint:

Power save (Energiesparmodus):
Automatische Abschaltung der Hintergrundbeleuchtung.
off (aus): Automatisches Abschalten deaktiviert.
on (ein): Automatisches Abschalten aktiviert.

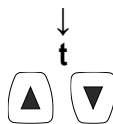

Stellen Sie über die Tasten **off** oder **on** ein.



Drücken Sie die Taste, um die Einstellung zu speichern.

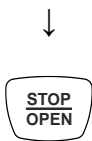

Drücken Sie die Taste einmal, um das Menü „-> Settings“ (Einstellungen) zu verlassen, oder zweimal, um das „* MACHINE MENU *“ (Gerätemenü) zu verlassen.



Beispiel:

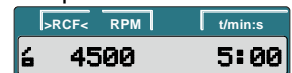

13.21 ABFRAGE DER ANZAHL DER BETRIEBSSTUNDEN UND ANZAHL DER ZENTRIFUGATIONSLÄUFE

Die Betriebsstunden sind in interne und externe Betriebsstunden eingeteilt. Interne Betriebsstunden: die gesamte Zeit, in der das Gerät eingeschaltet wurde. Externe Betriebsstunden: die Gesamtzeit der bisherigen Zentrifugationsläufe. Bei Stillstand des Rotors kann die Abfrage wie folgt durchgeführt werden.

Der Vorgang kann jederzeit durch Drücken der  Taste abgebrochen werden.



Halten Sie die Taste für 8 Sekunden gedrückt.

>RCF<	RPM	t/min:s
* MACHINE MENU *		



Drücken Sie die Taste, bis Folgendes angezeigt wird:

>RCF<	RPM	t/min:s
-> Time & Cycles		



Drücken Sie die Taste.
TimeExt: Externe Betriebsstunden.

Beispiel:

>RCF<	RPM	t/min:s
TimeExt=		43 h



Drücken Sie die Taste.
TimeInt: Interne Betriebsstunden.

Beispiel:

>RCF<	RPM	t/min:s
TimeInt=		60 h



Drücken Sie die Taste.
Starts: Anzahl aller Zentrifugationsläufe.

Beispiel:

>RCF<	RPM	t/min:s
Starts=		325



Drücken Sie Taste zweimal, um das Menü „-> Time & Cycles“ (Zeit und Zyklen) zu verlassen, oder drücken Sie sie dreimal, um das „* MACHINE MENU *“ (Gerätemenü) zu verlassen.

Beispiel:

>RCF<	RPM	t/min:s
* MACHINE MENU *		

>RCF<	RPM	t/min:s
6	4500	5:00

14 FEHLER

Wenn der Fehler mithilfe der nachstehenden Fehlertabelle nicht behoben werden kann, wenden Sie sich an den Kundendienst und geben Sie den Zentrifugentyp und die Seriennummer an. Beide Nummern finden sich auf dem Typenschild der Zentrifuge.



Führen Sie ein MAINS RESET (Aus- und Einschalten) durch: Schalten Sie den Netzschalter aus (Schalterposition „0“). Warten Sie mindestens 10 Sekunden und schalten Sie dann den Netzschalter wieder ein (Schalterposition „I“).

Nachricht/Fehler		Ursache	Abhilfe
Keine Anzeige		Keine Spannung. Netzeingangssicherungen defekt.	<ul style="list-style-type: none"> – Überprüfen Sie die Verteilerspannung. – Überprüfen Sie die Netzsicherung und lesen Sie die Anweisungen zum Wechseln der Netzsicherung. – Netzschalter EIN.
IMBALANCE (Unwucht)		Der Rotor ist ungleich beladen.	<ul style="list-style-type: none"> – Öffnen Sie den Deckel, wenn der Rotor stillsteht. – Überprüfen Sie die Beladung des Rotors. – Wiederholen Sie den Zentrifugationslauf.
MAINS INTER (Stromunterbrechung)	11	Stromausfall während des Zentrifugationslaufs. (Der Zentrifugationslauf war noch nicht beendet.)	<ul style="list-style-type: none"> – Öffnen Sie den Deckel, wenn der Rotor stillsteht. – Drücken Sie die „start/pause“-Taste. – Wiederholen Sie, falls nötig, den Zentrifugationslauf.
MAINS INTERRUPT (Stromunterbrechung)			
TACHO ERROR (Fehler Drehzahlimpulse)	1, 2	Ausfall von Drehzahlimpulsen im Betrieb.	<ul style="list-style-type: none"> – Führen Sie einen MAINS RESET durch, wenn der Rotor stillsteht.
LID ERROR (Fehler Deckel)	4.1 – 4.127	Fehler bei der Deckelverriegelung oder bei der Deckelschließung.	
OVER SPEED (Drehzahl zu hoch)	5	Rotation zu schnell	
VERSION ERROR (Versionsfehler)	12	Falsches Zentrifugenmodell erkannt. Fehler / defekte Elektronik	<ul style="list-style-type: none"> – Führen Sie einen MAINS RESET durch, wenn der Rotor stillsteht.
UNDER SPEED (Drehzahl zu niedrig)	13	Rotation zu langsam	
CTRL ERROR (Fehler Steuerung)	22.1, 25.2	Fehler / defekte Elektronik	
CRC ERROR (Fehler Schaltkreis)	27.1		
COM ERROR (Fehler Elektronik)	31 – 36		
FC ERROR (Fehler FC)	60, 61.1 – 61.21, 61.64 – 61.142		
FC ERROR (Fehler FC)	61.23		
TACHO ERR (Fehler Drehzahlimpulse)	61.22	Drehzahlmessfehler	
FC ERROR (Fehler FC)	61.153	Fehler / defekte Elektronik	<ul style="list-style-type: none"> – Führen Sie einen MAINS RESET durch. – Überprüfen Sie die Belastung des Rotors gemäß den Anweisungen. – Wiederholen Sie den Zentrifugationslauf.

15 RELATIVE ZENTRIFUGALKRAFT (RCF)

Die relative Zentrifugalkraft (RCF) wird als Vielfaches der Beschleunigung der Schwerkraft (g) angegeben. Es handelt sich um einen einheitsfreien Wert und dient zum Vergleich der Trenn- und Absetzleistung. Die relative Zentrifugalkraft (RCF) steht im Zusammenhang mit der Drehzahl (Umdrehungen pro Minute) und dem Zentrifugationsradius. Sie kann mit der folgenden Formel berechnet werden:

$$\text{RCF} = \left(\frac{\text{RPM}}{1000} \right)^2 \times r \times 1,118 \quad \Rightarrow \quad \text{RPM} = \sqrt{\frac{\text{RCF}}{r \times 1,118}} \times 1000$$

RCF = relative Zentrifugalkraft

RPM = Drehzahl (Umdrehungen pro Minute)

r = Zentrifugationsradius in mm = Abstand von der Mitte der Drehachse zum Boden des Zentrifugenbehälters.

16 TRANSPORT UND LAGERUNG

Vor dem Transport des Geräts muss die Transportsicherungsvorrichtung installiert werden. Das Gerät und das Zubehör dürfen nur in geschlossenen und trockenen Räumen gelagert werden. Wenn das Gerät und das Zubehör transportiert oder gelagert werden, müssen die folgenden Bedingungen erfüllt sein:

Umgebungstemperatur: -20 °C bis 60 °C.

Relative Luftfeuchtigkeit: 10 % bis 80 %, nicht kondensierend.

17 ÄNDERUNG DER NETZEINGANGSSICHERUNGEN

Schalten Sie zunächst den Netzschalter aus und trennen Sie das Gerät vom Netz. Der Sicherungshalter (A) mit den Netzeingangssicherungen befindet sich neben dem Netzschalter. Ziehen Sie das Anschlusskabel aus der Gerätebuchse. Drücken Sie den Schnappverschluss (B) gegen den Sicherungshalter (A) und entfernen Sie ihn. Tauschen Sie defekte Netzeingangssicherungen aus. Verwenden Sie nur Sicherungen mit der für den vom Hersteller angegebenen Zentrifugentyp festgelegten Nennleistung. Führen Sie den Sicherungshalter wieder ein, bis der Schnappverschluss mit einem Klicken einrastet. Schließen Sie das Gerät an die Netzversorgung an.

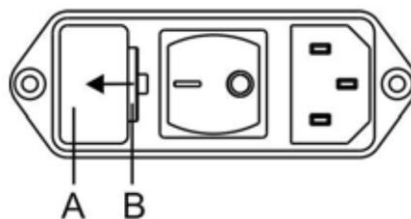

18 RÜCKSENDUNG VON GERÄTEN

Vor der Rücksendung des Geräts muss eine Transportsicherungsvorrichtung installiert werden. Wenn das Gerät oder sein Zubehör an einen legalen Hersteller zurückgesandt wird, muss es vor dem Versand dekontaminiert und gereinigt werden, um Menschen, Umwelt und Materialien zu schützen. Der gesetzliche Hersteller behält sich das Recht vor, kontaminierte Geräte oder Zubehörteile abzulehnen. Kosten für Reinigung und Desinfektion sind vom Kunden zu tragen.

19 ENTSORGUNG

Vor der Entsorgung muss das Gerät dekontaminiert und gereinigt werden, um Menschen, Umwelt und Anlagen zu schützen. Bei der Entsorgung des Geräts sind die jeweiligen gesetzlichen Vorschriften zu beachten. Gemäß Richtlinie 2002/96/EG (WEEE) dürfen alle Geräte, die nach dem 13. August 2005 geliefert werden, nicht als Teil des Hausmülls entsorgt werden. Das Gerät gehört zur Gruppe 8 (Medizinprodukte) und ist dem rein geschäftlichen Bereich zugeordnet. Das Symbol der durchgestrichenen Mülltonne zeigt an, dass das Gerät nicht im Hausmüll entsorgt werden darf. Die Abfallentsorgungsrichtlinien der einzelnen Länder können unterschiedlich sein. Wenden Sie sich falls notwendig an Ihren Lieferanten.

ARCHIVED DOCUMENT



Le tableau des symboles ci-dessous est pour référence seulement. Reportez-vous à l'étiquette d'emballage du produit pour connaître les symboles applicables.

Symbole	Description du symbole
	Attention
	Mode d'emploi électronique
	Fabricant
	BioHorizons produits portent le marquage CE et satisfont aux exigences de la directive 93/42/CEE relative aux dispositifs médicaux
	Référence/numéro d'article
	Numéro de lot/lot
	Ne pas réutiliser
	Ne pas restériliser.
	Date de péremption
	Stérile par rayonnement gamma
	Date de fabrication
	Attention: La loi fédérale des États-Unis limite la vente, la distribution et l'utilisation de ces dispositifs à un dentiste ou à un médecin sur prescription

Symbole	Description du symbole
	Position d'origine
	Ne pas utiliser si l'emballage est endommagé
	Dispositif médical
	Non stérile
	Garder au sec
	Fragile; manipuler avec soin
	Limites de température
	Cette direction vers le haut
	Limites d'humidité
	Avertissement; Risque biologique
	Notes Importantes
	Collection séparée d'appareils électriques et électroniques.
	Représentant Autorisé de l'UE

1 INDICATIONS D'UTILISATION

Le système IntraSpin est destiné à être utilisé pour la préparation sûre et rapide de fibrine autologue riche en plaquettes (L-PRF) à partir d'un petit échantillon de sang prélevé au chevet du patient. La L-PRF est mélangée à une autogreffe et/ou allogreffe osseuse avant application sur une anomalie osseuse pour améliorer les caractéristiques de manipulation. L'observation de toutes les informations dans le mode d'emploi fait également partie de l'utilisation prévue.

2 CONTRE-INDICATIONS

La centrifugeuse IntraSpin est uniquement destinée à l'usage indiqué dans l'utilisation prévue de l'appareil. Toute autre utilisation de l'appareil est considérée comme non prévue. L'utilisation de la centrifugeuse IntraSpin est contre-indiquée en présence d'une ou plusieurs des situations cliniques suivantes: patients présentant une dépendance à l'alcool ou des troubles psychiatriques, des dyscrasies sanguines, un diabète non contrôlé, une hyperthyroïdie, des infections buccales, des tumeurs malignes ou des patients qui ont subi un infarctus du myocarde au cours des dernières 12 mois. Les patients atteints de maladies systémiques qui compromettent le système immunitaire, comme le SIDA, les patients prenant des médicaments qui compromettraient la guérison d'un site implantaire, les patients ayant des antécédents de mauvaise ou de non-conformité aux procédures d'hygiène buccale.

Les patients qui participent à un traitement anti-coagulant. Ces patients ne sont pas exclus des avantages du PRF, mais le point de soins doit ajouter du temps supplémentaire à la centrifugeuse pour que la séparation soit efficace pour une utilisation.



3 NOTES DE SÉCURITÉ

- Aucune demande garantie ne pourra être revendiquée auprès du fabricant si les indications données dans ce mode d'emploi ne sont pas toutes respectées.
- Le mode d'emploi fait partie de l'appareil. Ils doivent toujours être facilement accessibles. Si l'appareil est installé à un emplacement différent, le mode d'emploi doit être fourni avec celui-ci.
- Veiller à la stabilité de la centrifugeuse.
- Avant d'utiliser la centrifugeuse, il est indispensable de vérifier la fixation correcte du rotor.
- Durant un processus de centrifugation, aucune personne, matière dangereuse et aucun objet ne doivent se trouver dans une zone de sécurité de 300 mm autour de la centrifugeuse.
- Les rotors, balanciers et accessoires qui présentent d'importantes traces de corrosion ou des défauts mécaniques ou dont la durée d'utilisation a expiré ne doivent plus être utilisés.
- Suspendre immédiatement l'utilisation de la centrifugeuse si la cuve de centrifugeuse présente des dommages susceptibles de porter atteinte à la sécurité.
- Concernant les centrifugeuses sans réglage de température, il peut y avoir un réchauffement dans la cuve de centrifugeuse en cas de température ambiante élevée et/ou d'utilisation fréquente de l'appareil. Il n'est donc pas possible d'exclure une modification de l'échantillon due à la température.
- Il importe de lire et de respecter le mode d'emploi avant la mise en service de la centrifugeuse. Seules les personnes ayant lu et compris le mode d'emploi sont autorisées à manipuler l'appareil.
- Outre le mode d'emploi et les réglementations contraignantes relatives à la prévention des accidents, il importe également de respecter les règles spécifiques et communément admises en matière de sécurité et de travail. Le mode d'emploi doit être complété des dispositions nationales applicables à la prévention des accidents et à la protection de l'environnement.

- Le fait de respecter les prescriptions nationales relatives à la sécurité au travail concernant l'utilisation de centrifugeuses sur le lieu de travail prévu à cet effet par l'exploitant relève de la responsabilité du dit exploitant.
- La centrifugeuse a été construite conformément à l'état actuel de la technique et son fonctionnement est sûr. Elle peut cependant présenter des dangers pour l'utilisateur ou des tiers si son utilisation n'est pas confiée à un personnel dûment formé, est inadéquate ou non conforme à sa destination.
- Pendant le fonctionnement, la centrifugeuse ne devra pas être déplacée ou être heurtée.
- En cas de défaillance ou en cas de déverrouillage d'urgence, ne jamais intervenir dans l'appareil lorsque le rotor tourne.
- Afin d'éviter les dommages causés par la condensation en passant d'un local froid à un local chaud, il faut soit réchauffer la centrifugeuse en la laissant pendant au moins 3 heures dans le local chaud avant de la raccorder au secteur, soit la faire fonctionner pendant 30 minutes dans le local froid pour la chauffer.
- Dans le cas de la centrifugation à la vitesse maximale, la densité des substances et des mélanges de substances ne doit pas excéder 1,2 kg/dm³.
- Il est interdit de procéder à des centrifugations en présence de défauts d'équilibrage.
- La centrifugeuse ne doit pas être exploitée dans un environnement explosif.
- Il est interdit de procéder à des centrifugations avec des matières inflammables ou explosives, ou avec des matières susceptibles de réagir chimiquement ou de dégager d'importantes quantités d'énergie.
- Cette centrifugeuse ne dispose pas de système de sécurité biologique.
- Il est interdit de centrifuger des matières fortement corrosives pouvant réduire la résistance mécanique des rotors, des supports et des accessoires.
- Les réparations ne peuvent être effectuées que par une personne autorisée à cet effet par le fabricant.
- Afin d'offrir aux patients le niveau de sécurité clinique le plus élevé possible, les produits Intra-Lock sont fabriqués à partir de matériaux biocompatibles avec le plasma humain.
- Ce produit n'est pas autorisé à la vente sur tous les marchés et il est possible qu'il ne soit pas disponible sur votre marché. Veuillez consulter votre représentant local pour plus d'informations.

4 COMPOSANTS DU SYSTÈME INTRASPIN

COMPOSANT	QUANTITÉ PAR SYSTÈME
Centrifugeuse IntraSpin comprenant:	1
Câble d'alimentation	1
Fusible	2
Clé à main hexagonale	1
Greiner Tubes de prélèvement sanguin et tubes d'équilibrage (à usage unique)	150
Greiner Safety Blood Collection Set + Holder, 21G (à usage unique)	24
Garrot sans latex	1
Portoir de tubes à essai	1
Ciseaux courbes chirurgicaux	1
Pince à tissus chirurgicaux	1
Plateaux rond en acier inoxydable	1

Plateaux rectangulaire en acier inoxydable	1
Spatule porteuse biomatériaux	1
Double biomatériau Conditionneur	1
Boîte Xpression®	1

Seuls les composants compatibles vérifiés pour une utilisation directe avec la centrifugeuse IntraSpin sont recommandés et garantis:

PARTIE COMPATIBLE #	DESCRIPTION
455092	Tube 9ml CAT activateur de caillot de sérum, capuchon rouge
455001	Capuchon blanc 9 ml Z tube sans additif
BHEXZ (E613)	Clé hexagonale IntraSpin, 110v et 220v
BROTORZ (E3694)	Rotor IntraSpin, 100v et 220v
BPOWER110Z (E1673)	Cordon d'alimentation IntraSpin, 110 V
BPOWER220Z (E1669)	Cordon d'alimentation IntraSpin, 220v
BTUBEHOLDZ (E872 x 1)	Remplacement du support de tube IntraSpin
BFUSE110Z (E997)	Fusible IntraSpin 110v
BFUSE220Z (E891)	Fusible IntraSpin 220v

5 BRÈVE CONFIGURATION DE LA CENTRIFUGEUSE

Retirez et conservez les boulons de transport du bas de la centrifugeuse.

Branchez le câble CA et branchez-le dans une prise électrique.

Mettez la centrifugeuse sous tension en utilisant l'interrupteur à bascule à l'arrière de l'appareil.

Sélectionnez la vitesse et temporisation: Vitesse = 2700 & Temporisation = 12:00 min.

Appuyer sur START (DÉMARRER).

Le couvercle de la centrifugeuse s'ouvre automatiquement à la fin de chaque cycle.

Après la première procédure, la durée et la vitesse sont enregistrées dans la mémoire de la centrifugeuse à moins que les paramètres ne soient modifiés.

6 AVERTISSEMENTS ET INSTRUCTIONS POUR LES TUBES DE PRÉLÈVEMENT SANGUIN ET LES ENSEMBLES DE PRÉLÈVEMENT SANGUIN

- Ne pas utiliser de tubes en présence de corps étrangers.
- Laisser les tubes de prélèvement sanguin se remplir complètement.
- Manipuler tous les « objets tranchants » (par ex. aiguilles et ensembles de prélèvement sanguin) utilisés pour obtenir des échantillons biologiques et des prélèvement sanguin conformément aux politiques et procédures de votre établissement.
- Ne pas plier l'aiguille.
- Ne pas relâcher ni réactiver énergiquement le mécanisme de sécurité de l'aiguille une fois qu'il a été activé.
- Obtenir des soins médicaux appropriés en cas d'exposition à des échantillons biologiques (par exemple, par une blessure par piqûre) en raison de la transmission possible du VIH (sida), d'une hépatite virale ou d'autres maladies infectieuses.
- Jeter tous les « objets tranchants » de collecte de sang dans des récipients approuvés pour risques biologiques.

- Le transfert d'un échantillon d'une seringue vers un tube n'est pas une procédure recommandée.
- Si le sang est prélevé par voie intraveineuse (IV), suivez les politiques et procédures de votre établissement pour vous assurer que la ligne a été débarrassée de la solution IV avant de commencer à remplir les tubes de prélèvement sanguin.
- L'accélérateur de coagulation du sang peut apparaître blanc à la surface du tube, ce qui n'a aucun effet sur les performances des tubes. Si une autre décoloration ou précipité est présent dans le tube, il ne doit pas être utilisé.
- N'utilisez pas les tubes après la date d'expiration.
- Conserver les tubes de prélèvement sanguin entre 4 et 25 °C (40 et 77 °F).
- Conserver l'ensemble de prélèvement sanguin (aiguille et support) entre 4 et 36 °C (40 et 97 °F).
- Évitez l'exposition directe au soleil. Le dépassement de la température de stockage maximale recommandée peut entraîner une dégradation de la qualité du tube (c.-à-d. Perte de vide, coloration, etc.).
- Pour éviter le reflux, placez le bras du patient en position basse, maintenez le tube avec le capuchon vers le haut, libérez le garrot dès que le sang commence à couler dans le tube, évitez que le contenu du tube n'entre en contact avec le capuchon ou l'extrémité de l'aiguille pendant la ponction veineuse.
- Assurez-vous que les matériaux suivants sont facilement accessibles avant d'effectuer la ponction veineuse: tous les tubes de prélèvement sanguin nécessaires, les étiquettes identifiées pour l'identification positive des échantillons par le patient, les aiguilles et les supports de prélèvement sanguin, un tampon d'alcool pour nettoyer le site de ponction, la gaze propre, le garrot, le plâtre adhésif ou bandage, contenant approuvé pour les risques biologiques. Pour la protection contre l'exposition aux agents pathogènes transmissibles par le sang, un EPI (équipement de protection individuelle) approprié est recommandé (par exemple, gants, blouse de laboratoire, lunettes de protection, etc.).

Technique de ponction veineuse et prélèvement d'échantillons de sang:

Le prélèvement de sang doit être effectué aussi rapidement que possible, car il n'y a pas d'anticoagulant dans le tube de prélèvement. L'échantillon de sang commence à coaguler immédiatement. Porter des gants pendant la ponction veineuse et lors de la manipulation des tubes de prélèvement sanguin pour minimiser le risque d'exposition. Avant le prélèvement de sang, essuyer le dessus du capuchon des tubes de prélèvement sanguin à l'aide de la lingette désinfectante de votre choix. Retirez le couvercle sur la section de valve de l'aiguille. Préparez le site de ponction veineuse avec un antiseptique approprié. Ne pas palper la zone de ponction veineuse après le nettoyage. Placez le bras du patient vers le bas. Retirez le protège-aiguille. Effectuez la ponction veineuse avec le bras vers le bas et le capuchon du tube le plus haut. Immobiliser l'aiguille avec du ruban adhésif si nécessaire. Poussez le tube de prélèvement sanguin dans le support et sur la valve à aiguille perforant le diaphragme en caoutchouc du tube de prélèvement sanguin. Centrez les tubes de prélèvement sanguin dans le support lors de la pénétration du capuchon pour empêcher la pénétration des parois latérales et la perte de vide prématurée qui en résulte. Retirez le garrot dès que du sang apparaît dans le tube de prélèvement sanguin. Pendant la procédure, maintenez toujours le tube de prélèvement en place en appuyant dessus avec le pouce. Cela garantira un tirage sous vide complet. Le tube de prélèvement sanguin se remplira automatiquement. Si aucun sang ne coule dans le tube de prélèvement ou si le débit sanguin cesse avant de prélever un échantillon adéquat, les étapes suivantes sont suggérées pour compléter une collecte satisfaisante:

- Poussez le tube de prélèvement sanguin vers l'avant pour vous assurer que le capuchon a été pénétré.
- Confirmez la position correcte de l'aiguille dans la veine.
- Si le sang ne coule toujours pas, retirez et jetez le tube de collecte de manière appropriée. Procurez-vous un nouveau tube de prélèvement et poussez-le dans le support.
- Si le deuxième tube de collecte ne tire pas, retirez et jetez correctement l'aiguille et le tube de collecte. Répétez la procédure.
- Lorsque le volume de remplissage maximal du tube de prélèvement sanguin a été atteint, retirez-le délicatement du support. Répétez avec un deuxième tube de prélèvement sanguin.

Retournez doucement chaque tube de collecte immédiatement après l'avoir retiré du support. Ne secouez pas les tubes remplis d'échantillon de sang. Un mélange vigoureux peut provoquer un moussage ou une hémolyse. Un mélange insuffisant ou un mélange retardé dans les tubes de sérum peut entraîner un retard de la coagulation.

Une fois le prélèvement d'échantillon sanguin terminé, retirez l'aiguille de la veine. Activer le mécanisme de sécurité (écran de sécurité) de l'aiguille en appuyant des deux côtés de l'embase pour amorcer le verrou. Faire glisser le mécanisme de sécurité vers l'arrière jusqu'à entendre un dé clic. Ne pas repositionner l'embout de l'aiguille car cela augmente le risque de blessure par piqûre d'aiguille et d'exposition du sang. Jeter l'aiguille usagée avec le support dans un conteneur d'élimination des déchets biologiques dangereux approprié.. Appliquez une pression sur le site de ponction avec un tampon stérile sec jusqu'à l'arrêt du saignement. Si vous le souhaitez, appliquez un bandage une fois la coagulation terminée. Il est recommandé de conserver les tubes de collecte remplis en position verticale. Une fois que le second tube est plein, le retirer et placer les premier et second tubes dans la centrifugeuse à des emplacements opposés pour contrebalancer le rotor. Fermer le couvercle de la centrifugeuse IntraSpin® et appuyer sur le bouton « START » (DÉMARRER) pour le faire tourner pendant 12 MINUTES.

Si plus de deux tubes de sang sont nécessaires, suivre cette autre procédure : une fois les deux premiers tubes de sang prélevés et soigneusement inversés, les placer immédiatement dans la centrifugeuse IntraSpin, à l'opposé l'un de l'autre pour s'assurer que la centrifugeuse est correctement équilibrée. Fermez le couvercle et appuyez sur le bouton START et laissez la centrifugeuse fonctionner pendant que vous récupérez les tubes de sang restants. Appuyez sur le bouton STOP et laissez la centrifugeuse s'arrêter complètement. Le couvercle s'ouvrira; placer immédiatement les tubes restants dans la centrifugeuse en face l'un de l'autre pour assurer un bon équilibre et appuyer sur le bouton START pour réinitialiser et terminer le protocole recommandé.

Toujours placer les tubes par paires et les placer dans des positions opposées pour équilibrer le rotor de la centrifugeuse. Les tubes doivent toujours être équilibrés dans le rotor avant d'appuyer sur le bouton START (DÉMARRER), sinon cela pourrait endommager gravement la centrifugeuse, entraîner une coagulation et/ou une séparation incorrectes. Si les tubes ne sont pas correctement équilibrés, il y aura trop de vibrations pendant la centrifugation et un mauvais caillot de fibrine L-PRF en résultera.

Si vous avez un nombre impair d'échantillons sanguins à centrifuger, placez un tube d'équilibrage à capuchon blanc (p. ex., 455001) rempli d'eau jusqu'à la ligne de remplissage indiquée, à l'opposé du tube non apparié dans le rotor. Cela permettra d'équilibrer la centrifugeuse.

Commencer la centrifugation immédiatement après le prélèvement des échantillons de sang. Les retards affectent la procédure de séparation du sang et entraînent un faible caillot de fibrine L-PRF.

7 PREPARATION L-PRF

Après centrifugation, trois segments sont visibles:

1. Segment supérieur = plasma pauvre en plaquettes (PPP).
2. Segment médian = caillot de fibrine : L-PRF®.
3. Segment inférieur = caillot de globules rouges.

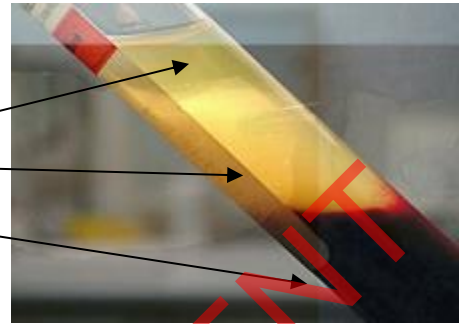

Les membranes ou bouchons de fibrine L-PRF® doivent être préparés relativement rapidement : 0 à 15 minutes après la centrifugation ou le caillot rétrécira en volume en libérant le sérum piégé. Après centrifugation retirer le bouchon en caoutchouc de chaque tube. À l'aide de la pince chirurgicale pour tissus, retirer le caillot de L-PRF du tube. Grattez doucement le caillot de globules rouges du caillot de fibrine L-PRF® juste en dessous de l'union, à l'aide de la spatule porte-biomatériaux double, de sorte que seule une quantité résiduelle minimale de globules rouges est attachée au caillot de L-PRF. Placer le caillot de fibrine sur le plateau perforé Xpression.

8 PREPARATION DE LA MATRICE DE FIBRINE

Protocole n° 1 L-PRF Membrane

Placer chacun des caillots de fibrine sur le plateau perforé Xpression. Une fois que tous les caillots de fibrine sont placés, placer la plaque de compression Xpression et le couvercle pondéré Xpression sur les caillots de fibrine sans exercer de pression sur les caillots.

Laisser le poids du couvercle appuyer lentement sur le caillot de fibrine pendant que l'exsudat est filtré au fond du plateau. N'appuyez pas sur le couvercle lesté. La force gravitationnelle sur la couverture lestée compresse délicatement le caillot et extrait le sérum du caillot de PRF sans endommager le réseau de fibrine.

Attendre au moins 5 minutes avant de retirer et d'utiliser les membranes de fibrine. Ne retirer la membrane de fibrine qu'au moment de son utilisation. La membrane de fibrine peut rester dans la boîte Xpression® pour une période allant jusqu'à 3 heures.



Protocole n° 2 - L-PRF Boushon

Placer un caillot de fibrine à l'intérieur du cylindre blanc. Utiliser le piston pour enfoncer lentement le caillot à l'intérieur du cylindre de fabrication du bouchon L-PRF blanc. Continuer à appuyer jusqu'à ce que le bord supérieur du piston soit au ras du bord supérieur du cylindre de fabrication du bouchon L-PRF blanc. Cette technique permet de former un bouchon de fibrine épais et rond pour l'alvéole d'extraction. Pour une seule dent, un bouchon L-PRF® peut être suffisant. Les prémolaires peuvent nécessiter deux bouchons en L-PRF® et trois bouchons en L-PRF® peuvent être nécessaires pour les molaires, en fonction de la taille de l'alvéole d'extraction et de la taille du caillot de fibrine créé.

Les propriétés de fonctionnement de la L-PRF® constituent un excellent moyen d'utilisation en association avec votre biomatériau de préférence. En utilisant l'un des protocoles de mélange suivants, le biomatériau est saisi dans la membrane de fibrine en augmentant sa manipulation et ses capacités biologiques.

Protocole n°3- Mélange biomatériau/ Mélange L-PRF

Pour créer un mélange de type « mastic » pouvant être formé délicatement à l'aide de l'instrument du biomatériau dans la forme et l'épaisseur souhaitées, utiliser le protocole suivant: Couper doucement la membrane de fibrine L-PRF® en petits morceaux dans une boîte stérile avec les ciseaux courbes chirurgicaux. Ajouter la quantité désirée de matériau de greffe osseuse. Mélanger soigneusement la L-PRF® et le matériau de greffe osseuse. Ce mélange peut être placé dans les déficiences à l'aide d'une spatule porte-biomatériaux double.



Protocole n°4- Mélange biomatériau / matrice de L-PRF

Placer la quantité prédéterminée de matériau de greffe osseuse dans un bol ou plateau stérile. Immerger le(s) membrane(s) de L-PRF® extrait(s) ou morceaux de la membrane de L-PRF® dans le matériau de greffe en couvrant toute la surface de la membrane de L-PRF® avec le matériau de greffe. Alternatively, the graft material may be sprinkled onto the L-PRF membrane covering the entire surface area with graft material. Remarque : une membrane L-PRF® humide peut conserver un peu plus de matériau de greffe qu'une membrane PRF séchée. Le matériau de greffe doit coller à la surface de la L-PRF®, cependant, il est également possible de pousser délicatement le matériau de greffe dans la membrane L-PRF®. Le forceps de tissu chirurgical peut être utilisé pour placer ce mélange dans la défectuosité.

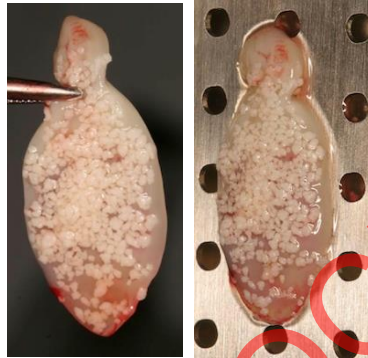

Protocole n°5- Hydratation des biomatériaux

Ajouter la quantité désirée de matériel de greffe osseuse dans un bol ou un plateau stérile. Utilisez l'exsudat du bas du plateau de recueil Xpression pour hydrater le matériel de greffe. Mélanger soigneusement l'exsudat et la greffe osseuse. Ce mélange peut être placé dans les défectuosités à l'aide de la spatule porte-biomatériaux double.



9 KIT DE RÉGÉNÉRATION DES TISSUS NETTOYAGE ET STÉRILISATION

La boîte Xpression® permet de fabriquer des matrices de fibrine d'épaisseur constante en toute simplicité. L'exsudat peut être collecté à partir du plateau de collecte Xpression, sous le plateau perforé Xpression. La boîte Xpression® est composée des cylindres de fabrication de bouchons L-PRF et un piston pour fabriquer des bouchons L-PRF qui s'adaptent facilement aux alvéoles post-extractionnelles.



Couverture Pondérée
Xpression



Plaque de compression
Xpression



Plateau perforé Xpression dans le
plateau de collection Xpression

La boîte Xpression et les instruments auxiliaires NE SONT PAS fournis stériles. Retirez et jetez tout matériel d'expédition avant la stérilisation initiale. Nettoyez et stérilisez la boîte Xpression et les instruments auxiliaires avant chaque utilisation.

Démontez la boîte Xpression avant chaque cycle de nettoyage et de stérilisation pour éviter l'encapsulation des débris, la décoloration du matériau et / ou le séchage inadéquat des composants. Les cylindres de fabrication de bouchons L-PRF et le passe-fil de piston ne sont pas destinés à être retirés du plateau perforé Xpression pour le nettoyage et la stérilisation.

Nettoyage: (1) Éliminez tous les débris visibles des composants de la boîte Xpression et des instruments auxiliaires à l'aide d'une brosse à poils doux et d'un agent de nettoyage ou de désinfection à large spectre comme Enzymax® de Hu-Friedy ou équivalent. Rincez abondamment. (2) Placer les composants boîte Xpression et les instruments auxiliaires dans un récipient de taille appropriée de la même solution et soniquer pendant 10 minutes. Rincez abondamment. (3) Rincez les composants de la boîte Xpression et les instruments auxiliaires avec de l'alcool isopropylique pour éliminer tout résidu de savon et minéraux. (4) Épongez les composants de la boîte Xpression et les instruments auxiliaires avec une serviette non pelucheuse et séchez complètement à l'air. Reportez-vous à l'étiquetage de l'agent de nettoyage utilisé pour les instructions d'utilisation.

Stérilisation: (1) Placez la boîte Xpression et les instruments auxiliaires réassemblés dans un sac ou un emballage de stérilisation approuvé par la FDA. (2) Exécutez l'un des cycles de stérilisation qualifiés suivants:

Méthode De Stérilisation	Température	Durée D'exposition	Temps De Séchage Minimum
Vapeur Pré-vide (ANSI/AAMI ST79)	132°C (270°F)	4min	20-30 minutes
Vapeur Pré-vide (UK DoH Health Technical Memorandum 01-01)	134°C (273°F)	3min	20-30 minutes

Attention! Un nettoyage incorrect peut entraîner une stérilisation inadéquate. Le fait de ne pas sécher complètement les composants Xpression Box et les instruments auxiliaires pendant l'autoclavage peut laisser de l'humidité et provoquer une décoloration et une oxydation. L'utilisation de peroxyde d'hydrogène ou d'autres agents oxydants endommagera la surface des composants du Xpression Box et des instruments auxiliaires. Il est recommandé de tester, de nettoyer et d'étalonner périodiquement l'équipement de l'autoclave pour s'assurer que l'unité reste en bon état de fonctionnement.

10 NETTOYAGE ET ENTRETIEN DE LA CENTRIFUGEUSE

L'appareil est peut-être contaminé. Retirer la prise de secteur avant de nettoyer. Ne pas nettoyer centrifuges, rotors et accessoires dans un lave-vaisselle. Seul le nettoyage manuel et une désinfection liquide sont autorisés. La température de l'eau doit être située entre 20 et 25 °C. Seuls les agents de nettoyage ou de désinfectants dont le pH est compris entre 5 et 8 et qui ne contiennent pas d'alcalis caustiques, de peroxydes, de composés chlorés, d'acides et de solutions alcalines peuvent être utilisés. Respecter impérativement les consignes spéciales d'utilisation données par le fabricant des agents de nettoyage et de désinfection, afin de prévenir la corrosion par les agents de nettoyage et de désinfection.

Nettoyer régulièrement le boîtier de la centrifugeuse et le compartiment de centrifugation et les laver en cas de besoin avec du savon ou un détergent doux et un chiffon humide pour éviter la corrosion par les impuretés adhérentes. Substances des nettoyants adéquats comprennent savon, tensioactifs anioniques et tensioactifs non ioniques. Après utilisation des nettoyants, enlevez les résidus en essuyant l'appareil avec un chiffon humide. Séchez immédiatement les surfaces après nettoyage. Sécher le bol avec un chiffon absorbant en cas de dépôt d'eau de condensation dans le bol de la centrifugeuse. Frotter légèrement le joint d'étanchéité en caoutchouc du compartiment de centrifugation, après chaque nettoyage, avec de la poudre de talc ou un produit d'entretien pour caoutchouc. Vérifiez tous les ans le bon état de la cuve. N'utilisez plus la centrifugeuse si elle présente des dommages susceptibles de porter atteinte à la sécurité. Auquel cas, contactez le service après-vente.

Pour la désinfection des surfaces, Le bol de la centrifugeuse doit être nettoyé immédiatement dans le cas où un matériau infectieux a pénétré dans le bol de la centrifugeuse. Substances des désinfectants adéquats comprennent éthanol, n-propanol, éthylènehexanol, surfactants anioniques et inhibiteurs de corrosion. Après utilisation de désinfectants, enlevez les résidus en essuyant l'appareil avec un chiffon humide. Séchez immédiatement les surfaces après désinfection.

Pour la décontamination de substances radioactives, l'agent employé doit expressément convenir pour une décontamination de substances radioactives. Substances des agents adaptés à une décontamination des substances radioactives comprennent tensioactifs anioniques, tensioactifs non ioniques, éthanol polyhydre. Après décontamination des substances radioactives, enlevez les résidus en essuyant l'appareil avec un chiffon humide. Séchez immédiatement les surfaces après décontamination des substances radioactives.

11 ROTOR ET ACCESSOIRES NETTOYAGE ET ENTRETIEN

Afin de prévenir la corrosion et toute modification des matériaux, il faut nettoyer régulièrement le rotor et les accessoires avec du savon ou un détergent doux et un chiffon humide. Il est vivement recommandé d'effectuer un nettoyage au moins une fois par semaine. Enlevez immédiatement les impuretés.

Substances des nettoyants adéquats incluent savon, agents anioniques et non ioniques. Après utilisation de nettoyants, enlevez les résidus en rinçant à l'eau claire (uniquement à l'extérieur de la centrifugeuse) ou en essuyant les surfaces avec un chiffon humide. Le rotor et les accessoires doivent être séchés immédiatement après le nettoyage. Vérifier une fois par semaine l'état des rotors et accessoires afin de détecter les éventuels dommages d'usure et d'oxydation. Le rotor et les accessoires ne doivent plus être utilisés aux premiers

signes d'usure ou de corrosion. Vérifier chaque semaine la stabilité de fixation du rotor. Si le rotor ou les accessoires sont infectés, procédez à une désinfection appropriée.

Substances des désinfectants adéquats incluent éthanol, n-propanol, éthylènehexanol, agents anioniques, inhibiteurs de corrosion. Après utilisation de désinfectants, enlevez les résidus en rinçant à l'eau claire (uniquement à l'extérieur de la centrifugeuse) ou en essuyant les surfaces avec un chiffon humide. Séchez le rotor et les accessoires immédiatement après désinfection.

Pour l'élimination des contaminants radioactifs, l'agent employé doit expressément convenir pour une décontamination de substances radioactives. Substances des agents adaptés à une décontamination des substances radioactives comprennent les tensioactifs anioniques, les tensioactifs non ioniques et l'éthanol polyhydraté. Après décontamination des substances radioactives, enlevez les résidus en rinçant à l'eau claire (uniquement à l'extérieur de la centrifugeuse) ou en essuyant les surfaces avec un chiffon humide. Séchez immédiatement le rotor et les accessoires après décontamination des substances radioactives.

Le rotor peut être passé à l'autoclave à 121 ° C / 250 ° F pendant 20 minutes et séché de manière appropriée. Pour des raisons de sécurité, il faut remplacer le rotor après 10 stérilisations par autoclave. La stérilisation en autoclave accélère le processus de vieillissement et peut provoquer une décoloration. Après stérilisation en autoclave, attendez que le rotor se soit refroidi à la température ambiante avant de le réutiliser. Nous ne pouvons faire aucune déclaration sur le degré de stérilisation.

La durée d'utilisation du rotor est limitée à 50 000 cycles de fonctionnement (cycles de centrifugation) ou 5 ans, selon la première éventualité. Le nombre maximum de cycles autorisés est indiqué sur le rotor. Pour des raisons de sécurité, l'utilisation du rotor n'est plus autorisée dès que le nombre maximum de cycles spécifiés est atteint. L'appareil est équipé d'un compteur qui compte les cycles de centrifugation.

En cas de rupture du tube sanguin, toutes les parties cassées et le sang doivent être complètement retirés. La centrifugeuse doit être soigneusement nettoyée comme indiqué et les inserts en caoutchouc ainsi que les manchons en plastique du rotor doivent être remplacés.

12 SPÉCIFICATIONS TECHNIQUES DE LA CENTRIFUGEUSE

Type de modèle	IS220Z	IS110Z
Tension du réseau ($\pm 10\%$)	200 - 240 V 1~	100 - 127 V 1~
Fréquence du réseau	50 - 60 Hz-	50 - 60 Hz
Charge de connexion	100 VA	100 VA
Consommation de courant	0.5 A	1.0 A
Capacité	8 x 10 ml	
Densité maximale admise	1.2 kg/dm ³	
Vitesse de rotation maximale (RPM)	6,000	
Accélération (RCF)	3,461	
Energie cinétique	750 Nm	
Emplacement	uniquement dans les intérieurs	
Hauteur	Jusqu'à 2 000 m au dessus du niveau de la mer	
Température ambiante de fonctionnement	5°C à 40°C	
Humidité relative pour le fonctionnement	humidité de l'air max. relative 80 % pour températures jusqu'à 31 °C, décroissant en linéaire jusqu'à 50 % de l'humidité	
Catégorie de surtension	II	
Degré d'encrassement	2	
Catégorie de protection de l'appareil	I	
	Non approprié pour l'usage dans un environnement exposé	
Emission de parasites, Résistance aux	EN / IEC 61326-1, Class B	FCC Class B
Niveau du bruit (en fonction du rotor)	≤ 50 dB(A)	
Largeur de centrifugeuse	261 mm	
Profondeur de centrifugation	353 mm	
Hauteur de centrifugeuse	228 mm	
Poids de la centrifugeuse	env. 9 kg	

13 INSTRUCTIONS D'UTILISATION DE LA CENTRIFUGEUSE

Retirez impérativement les dispositifs de sécurité, composé de 2 vis (a) et de 2 entretoises (b), pour le transport. Conservez ces dispositifs de sécurité afin de les réutiliser lors du transport ultérieur de l'appareil (leur montage est obligatoire). Le transport de l'appareil est exclusivement autorisé avec les dispositifs de sécurité correspondants. Pour protéger l'appareil pendant le transport, on fixe le moteur. Retirez impérativement ces dispositifs de sécurité pour le transport avant la mise en service de l'appareil.

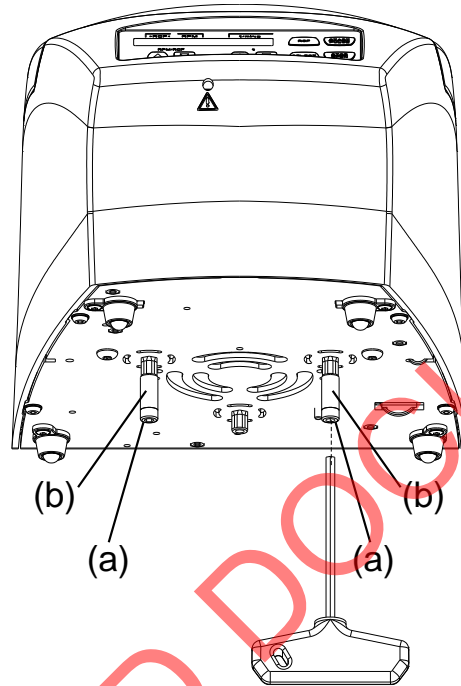

13.1 MISE EN SERVICE

- Retirez les dispositifs de sécurité du côté inférieur de la centrifugeuse.
- Placer la centrifugeuse sur un emplacement approprié de manière à ce qu'elle soit stable et mettre de niveau. Durant un processus de centrifugation, aucune personne, matière dangereuse et aucun objet ne doivent se trouver dans une zone de sécurité de 300 mm autour de la centrifugeuse.
- Ne pas recouvrir les fentes d'aération. Veuillez respecter un écart de 300 mm jusqu'aux fentes et ouvertures d'aération de la centrifugeuse.
- Vérifier que la tension de secteur est identique à la mention de la plaque signalétique.
- Brancher la centrifugeuse avec son cordon de raccordement sur une prise secteur aux normes.
- Allumer l'interrupteur de réseau.
- Les affichages suivants apparaissent sur le panneau: le modèle de centrifuge, la version du logiciel et les dernières données de centrifugation utilisées.
- Quand le couvercle est fermé, le message « Open the lid » s'affiche. Dans ce cas, ouvrir le couvercle afin que les données de centrifugation s'affichent.

13.2 OUVRIR ET FERMER LE COUVERCLE DE LA CENTRIFUGEUSE

Vous ne pouvez ouvrir le couvercle que si la centrifugeuse est en marche et le rotor à l'arrêt. Si le compteur de cycles est activé, le nombre de cycles de centrifugation restants s'affiche brièvement, après un cycle de centrifugation, pendant l'ouverture du couvercle.



Exemple:



Pour ouvrir le couvercle, appuyez sur la touche suivante . Le couvercle se déverrouille de manière motorisée.  indique que le couvercle est déverrouillé.

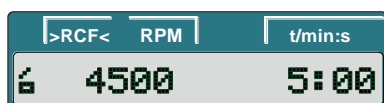

Exemple:

Ne pas mettre les doigts entre le couvercle et le boîtier. Ne pas fermer le couvercle violemment.

Pour fermer le couvercle, appuyez légèrement sur le bord avant du couvercle.  indique que le couvercle est verrouillé.

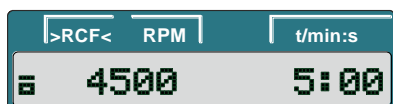

Exemple:

13.3 DEVERROUILLAGE DE SECOURS

En cas de panne de courant, il est impossible de déverrouiller le couvercle par voie moteur. Il faut donc procéder à un déverrouillage de secours manuel. Pour un déverrouillage de secours, débranchez la tension du réseau en mettant l'interrupteur en position « 0 ». Vérifiez par la fenêtre du couvercle que le rotor est bien à l'arrêt. N'ouvrez le couvercle que si le rotor est à l'arrêt. Insérez la clé six-pans à l'horizontale dans l'ouverture A et tournez la avec précaution dans le sens inverse des aiguilles d'une montre (vers la gauche) jusqu'à ouverture du couvercle. PRUDENCE ! Tourner la clé hexagonale Allen dans le sens des aiguilles d'une montre (vers la droite) peut endommager le système de verrouillage. Retirez la clé six-pans de l'ouverture.

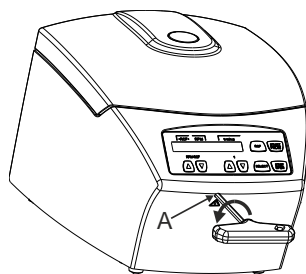

13.4 MONTAGE ET DEMONTAGE DU ROTOR

Pour retirer le rotor, Avec la clé hexagonale fournie, desserrer l'écrou du rotor en tournant dans le sens inverse des aiguilles d'une montre, et tourner jusqu'au point de pression pour le retrait. Après avoir franchi

ce point de pression, le rotor se détache du cône de l'arbre moteur. Tourner l'écrou jusqu'à pouvoir soulever le rotor de l'arbre moteur. Ôter le rotor de l'arbre moteur.

Pour installer le rotor, Nettoyer l'arbre moteur (A) et l'ouverture du rotor, graisser ensuite légèrement l'arbre moteur. La présence d'impuretés entre l'arbre moteur et le rotor empêche au rotor d'avoir une position parfaite, et provoque un fonctionnement irrégulier du rotor. Placer le rotor à la verticale sur l'arbre moteur. En posant le rotor, la barre de repère (B) sur le rotor doit se trouver en parallèle aux deux surfaces (C) de l'arbre moteur. Avec la clé hexagonale fournie, serrer l'écrou du rotor en tournant dans le sens des aiguilles d'une montre. Vérifier si le rotor se trouve dans une position fixe..

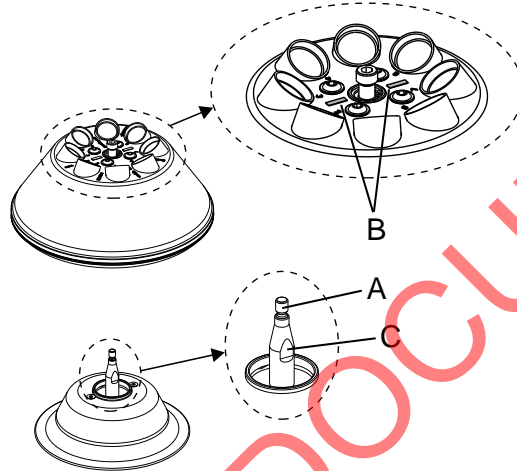

Les rotors doivent uniquement être chargés de manière symétrique. Les tubes sanguins doivent être uniformément répartis sur toutes les positions du rotor.

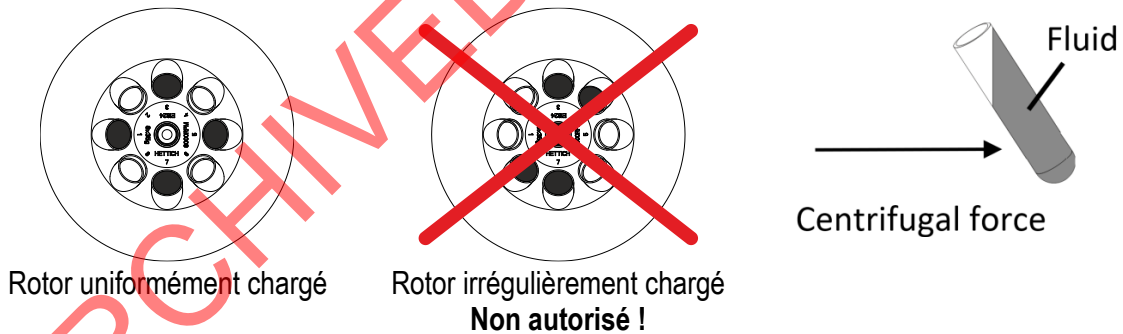

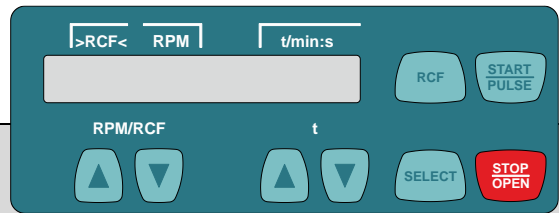

Remplissez les tubes sanguins uniquement en dehors de la centrifugeuse. La quantité maximale de remplissage pour les tubes de sang est indiquée sur les tubes eux-mêmes et ne doit pas dépasser le poids maximum indiqué sur le rotor. Remplir les réservoirs de centrifugation de sorte que du liquide ne puisse pas être projeté à l'extérieur pendant le cycle de centrifugation. Aucun fluide ne doit pénétrer dans le rotor et dans la cuve de centrifugeuse lors du chargement du rotor. Afin de maintenir les différences de poids à l'intérieur du récipient de la centrifugeuse aussi marginales que possible, un niveau de remplissage constant dans les tubes sanguins est recommandé.

13.5 DESCRIPTION DES ÉLÉMENTS D'AFFICHAGE



Symbole / Touches du champ	La Description
	Couvercle déverrouillé.
	Couvercle verrouillé
	Affichage de la rotation. L'affichage de rotation brille en tournant dans le sens inverse des aiguilles d'une montre lorsque le rotor tourne.
RPM/RCF 	Pour saisir directement la vitesse de rotation. Pour faire défiler plus rapidement les valeurs, maintenez la touche enfoncée.
t 	Pour saisir directement la durée de fonctionnement. Réglable en étapes de 1 seconde jusqu'à 1 minute et en étapes de 1 minute à partir de 1 minute. Pour saisir les paramètres de centrifugation. Pour faire défiler plus rapidement les valeurs, maintenez la touche enfoncée.
	Pour activer des paramètres individuels. Chaque pression supplémentaire de la touche permet de sélectionner le paramètre suivant. Appuyer sur la touche pendant 8 secondes pour appeler "MACHINE MENU". Dans « Machine Menu », sélectionner les menus « Info », « Settings » et « Time & Cycles ». Pour faire défiler les menus vers l'avant.
	Pour passer entre l'affichage de la vitesse (RPM) et l'affichage de la force centrifuge relative (>RCF<). Les valeurs RCF sont affichées entre parenthèses ><.
	Pour lancer le cycle de centrifugation. Pour le cycle de centrifugation court. Le cycle de centrifugation tourne tant que vous appuyez la touche. Pour sélectionner les menus "->Info", "->Settings" et "->Time & Cycles".
	Pour terminer le cycle de centrifugation. Le rotor s'arrête avec le niveau de freinage présélectionné. Pour appuyer deux fois la touche pour déclencher l'arrêt d'urgence. Déverrouiller le couvercle.
t/min	Durée de fonctionnement. Réglable de 1 à 99 min, en étapes de 1 minute.
t/sec	Durée de fonctionnement. Réglable de 1 à 59 s, en étapes de 1 seconde. Fonctionnement continu « --:-- ». Mettre les paramètres t/min et t/sec sur zéro.
RPM	Vitesse de rotation. Vous pouvez saisir une valeur numérique pour paramétrer un régime de 200 RPM jusqu'à vitesse maximum du rotor. Réglable en étapes de 10.
>RCF<	Accélération centrifuge relative. Vous pouvez saisir une valeur numérique pour paramétrer un régime de 200 RPM jusqu'à vitesse maximum du rotor. Réglable en étapes de 1. La saisie des données pour l'accélération centrifuge relative (RCF) n'est possible que si l'affichage RCF (>RCF<) est sélectionné. L'accélération centrifuge relative (RCF) dépend du rayon de centrifugation (RAD). Après saisie des données de RCF, vérifier que le rayon de centrifugation réglé soit correct.
RAD/mm	Rayon de centrifugation. Réglable de 10 mm à 250 mm, en étapes de 1 millimètre. La saisie du rayon de centrifugation n'est possible que si l'affichage RCF (>RCF<) est sélectionné.
~_DEC	Niveau de freinage. fast = temps d'arrêt court, slow = temps d'arrêt long.

13.6 SAISIE DIRECTE DES PARAMETRES DE CENTRIFUGATION

Vous pouvez saisir directement la vitesse de rotation (RPM), l'accélération centrifuge relative (RCF), le rayon de centrifugation (RAD) et la durée de fonctionnement avec les touches   sans devoir appuyer préalablement la touche . Les paramètres de centrifugation réglés ne sont enregistrés qu'après démarrage du cycle de centrifugation.

Pour la vitesse de rotation (RPM):

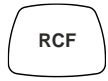

Au besoin, appuyez la touche pour sélectionner l'affichage de RPM.



Réglez la valeur souhaitée avec les touches.



Exemple:



Pour l'accélération centrifuge relative (RCF) et rayon de centrifugation (RAD):

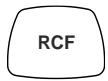

Au besoin, appuyez la touche pour sélectionner l'affichage RCF (>RCF<).



Régler la valeur RCF souhaitée avec les touches.

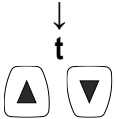

Au besoin, réglez le rayon de centrifugation souhaité avec les touches.

Exemple:

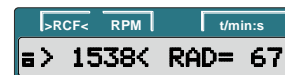

Durée de fonctionnement:

Vous pouvez régler la durée de fonctionnement jusqu'à 1 minute en étapes de 1 seconde, mais à partir de 1 minute, seulement en étapes de 1 minute. Pour régler fonctionnement continu, il faut mettre les paramètres t/min et t/sec sur zéro. L'affichage temps (t/min:s) indique « --:-- ».

Exemple:

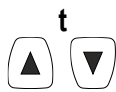

Régler la valeur souhaitée avec les touches.

Exemple:























13.7 SAISIE DES PARAMETRES DE CENTRIFUGATION AVEC LA TOUCHE « SELECT »

Vous pouvez régler la durée de fonctionnement en minutes et secondes (paramètres **t/min** et **t/sec**). Pour tourner en fonctionnement continu il faut mettre les paramètres **t/min** et **t/sec** sur zéro. L'affichage temps (t/min:s) indique « --:-- ».

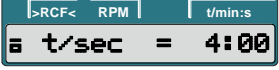
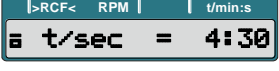

Exemple:

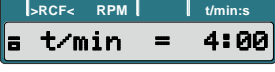
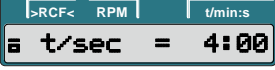
L'accélération centrifuge relative (RCF) dépend du rayon de centrifugation (RAD). Pendant la saisie des données de l'accélération RCF, le rayon de centrifugation configuré s'affiche. Si, après ou pendant la saisie de paramètres, vous n'appuyez pas de touche pendant 8 secondes, les paramètres précédents réapparaissent. Vous devez alors recommencer la saisie des paramètres. Appuyer sur la touche  pour enregistrer les réglages. Si vous saisissez plusieurs paramètres, n'appuyez la touche  qu'après avoir entré le dernier paramètre. Vous pouvez à tout moment interrompre la saisie des paramètres en appuyant la touche . Auquel cas, les réglages ne seront pas enregistrés.

 ↓  ↓   ↓  ↓   ↓ 	<p>Au besoin, appuyez la touche pour sélectionner l'affichage RPM (RPM) ou l'affichage RCF (>RCF<).</p> <p>Appuyez la touche. t/min : durée de fonctionnement, minutes.</p> <p>Réglez la valeur souhaitée avec les touches.</p> <p>Appuyez la touche. t/sec : durée de fonctionnement, secondes.</p> <p>Réglez la valeur souhaitée avec les touches.</p> <p>Appuyez la touche. RPM : vitesse de rotation (rotation par minute). RAD/mm : rayon de centrifugation. L'affichage et la saisie du rayon de centrifugation n'est possible que si</p>	<p>Exemple: affichage (RPM)</p>      	<p>Exemple: affichage (>RCF<)</p>      
--	---	---	---

l'affichage RCF (>RCF<) est sélectionné.

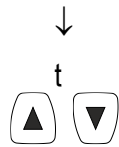

Réglez la valeur souhaitée avec les touches.

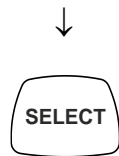
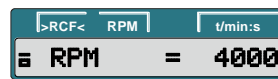

Appuyez la touche.
R : rayon de centrifugation.
RCF : accélération centrifuge relative.

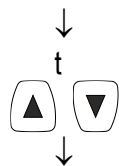

Réglez la valeur souhaitée avec les touches.



Appuyez la touche.
~_DEC : niveau de freinage.
fast : temps d'arrêt court.
slow : temps d'arrêt long.

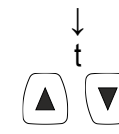

Réglez la valeur souhaitée avec les touches.

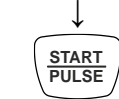

Appuyer sur la touche pour enregistrer les.

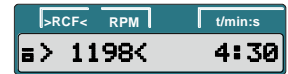

13.8 AFFICHAGE DU PANNEAU DE COMMANDE

Après le cycle de centrifugation, pendant le déverrouillage du couvercle, le nombre de cycles de centrifugation restants s'affiche brièvement.



En cas de dépassement de la différence de poids autorisée pour la charge du rotor, le cycle de centrifugation est interrompu au démarrage et "IMBALANCE" affichera.



Vous pouvez à tout moment interrompre un cycle de centrifugation en appuyant la touche . Vous pouvez sélectionner et modifier les paramètres de centrifugation pendant un cycle de centrifugation. Toutefois, les valeurs modifiées dans ces conditions ne s'appliqueront qu'au cycle de centrifugation en cours, elles ne seront pas enregistrées. Avec la touche , vous pouvez à tout moment commuter entre l'affichage RPM (RPM) et l'affichage RCF (>RCF<). Pour travailler avec l'affichage RCF (>RCF<), il faut saisir

les données du rayon de centrifugation. Cela signifie que vous ne pourrez continuer à utiliser la centrifugeuse qu'après ouverture du couvercle. Erreurs de commande et dérangements s'affichent.

Exemple: 

13.9 CENTRIFUGATION AVEC PRESELECTION TEMPS

 Au besoin, appuyez la touche pour sélectionner l'affichage RPM (RPM) ou l'affichage RCF (>RCF<).

↓

Saisir les paramètres de centrifugation souhaités.

↓

 Appuyez la touche pour lancer le cycle de centrifugation. Pendant le cycle de centrifugation, l'écran affiche la vitesse de rotation du rotor ou la valeur RCF en résultant, ainsi que le temps restant.

↓

A échéance du temps paramétré ou en cas d'arrêt du cycle de centrifugation avec la touche , l'arrêt se déclenche avec le niveau de freinage paramétré. Le niveau de freinage s'affiche \sim f.

Exemple: affichage (RPM)









Exemple: affichage (>RCF<)





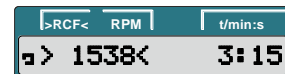

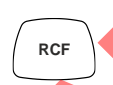

13.10 FONCTIONNEMENT CONTINU

 Au besoin, appuyez la touche pour sélectionner l'affichage RPM (RPM) ou l'affichage RCF (>RCF<).

↓

Saisir les paramètres de centrifugation souhaités. Mettre les paramètres t/min et t/sec sur zéro.

↓

Exemple: affichage (RPM)

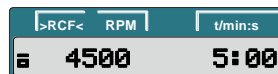



Exemple: affichage (>RCF<)







Appuyez la touche pour lancer le cycle de centrifugation. Pendant le cycle de centrifugation, l'écran affiche la vitesse de rotation du rotor ou la valeur RCF en résultant, ainsi que le temps restant.

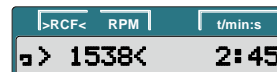
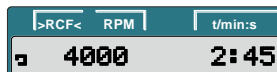

Appuyez la touche pour terminer le cycle de centrifugation. L'arrêt se déroule avec le niveau de freinage réglé. Le niveau de freinage s'affiche ~f.

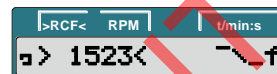

13.11 CYCLE DE CENTRIFUGATION COURT



Au besoin, appuyez la touche pour sélectionner l'affichage RPM (RPM) ou l'affichage RCF (>RCF<).

Exemple: affichage (RPM)

Exemple: affichage (>RCF<)



Saisir les paramètres de centrifugation souhaités.

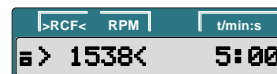
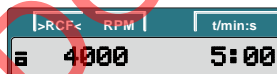

Appuyez la touche et maintenez la enfoncée. Pendant le cycle de centrifugation, l'écran affiche la vitesse de rotation du rotor ou la valeur RCF en résultant, ainsi que le temps écoulé.

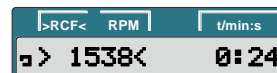

Relâchez la touche pour terminer le cycle de centrifugation. L'arrêt se déroule avec le niveau de freinage réglé. Le niveau de freinage s'affiche ~f.

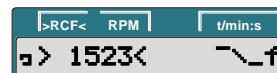
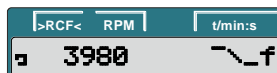

13.12 ARRET D'URGENCE

Exemple: affichage (RPM)

Exemple: affichage (>RCF<)



Appuyez la touche deux fois.
En cas d'arrêt d'urgence, l'arrêt se déroule avec le niveau de freinage « fast » (temps d'arrêt court). Le niveau de freinage s'affiche.



13.13 COMPTEUR DE CYCLES

La centrifugeuse est équipée d'un compteur qui compte les cycles de centrifugation. Après chaque cycle de centrifugation, pendant le déverrouillage du couvercle, le nombre de cycles de centrifugation restants s'affiche brièvement.



Lorsque le nombre maximum de cycles autorisé pour le rotor est atteint, l'écran affiche le message suivant à chaque démarrage d'un cycle de centrifugation. Vous devez relancer le cycle. Remplacer immédiatement le rotor par un neuf pour des raisons de sécurité. Après remplacement du rotor, remettre le compteur de cycles sur « 0 ».



13.14 REMETTRE LE COMPTEUR DE CYCLES A ZERO

Après remplacement du rotor, il faut remettre le compteur de cycles à zéro. Ne remettez le compteur de cycles à zéro qu'après remplacement de l'ancien rotor par un neuf. Lorsque le rotor est à l'arrêt, vous pouvez réinitialiser le compteur de cycles comme suit. Vous pouvez à tout moment interrompre la procédure en

appuyant la touche . Auquel cas, les réglages ne seront pas pris en compte.



Appuyez la touche pendant 8 secondes.



Appuyez sur la touche jusqu'à affichage de l'écran suivant.



Appuyez la touche.

Exemple:



Appuyez sur la touche jusqu'à affichage de l'écran suivant.
Cyc sum : nombre de cycles effectués.



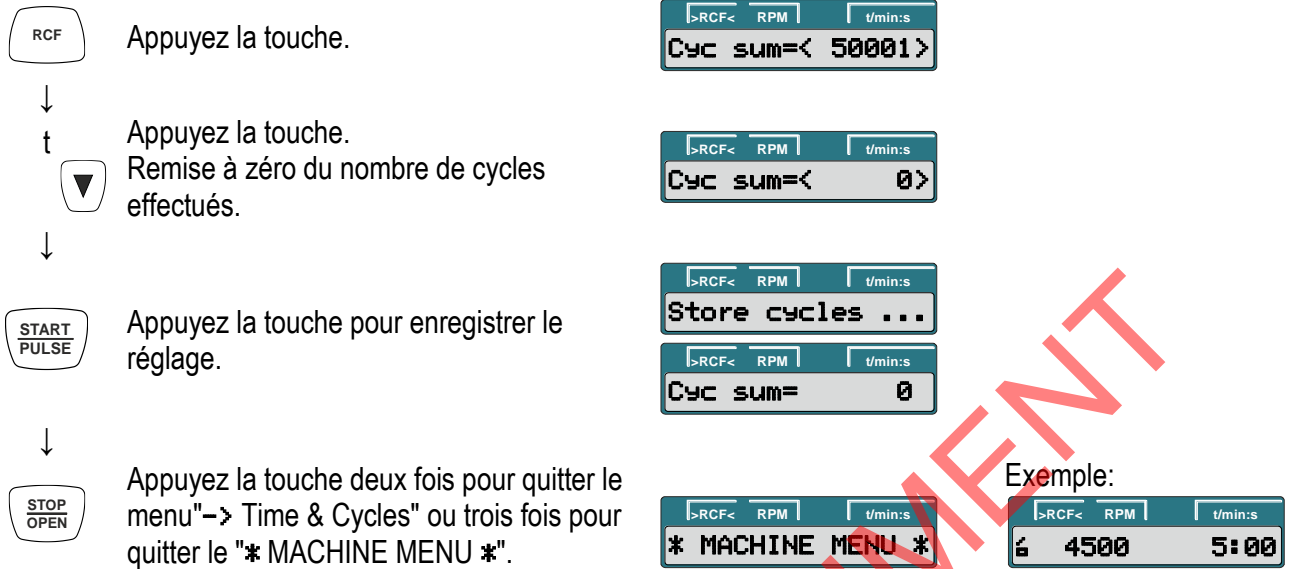

13.15 REGLAGES ET DEMANDES

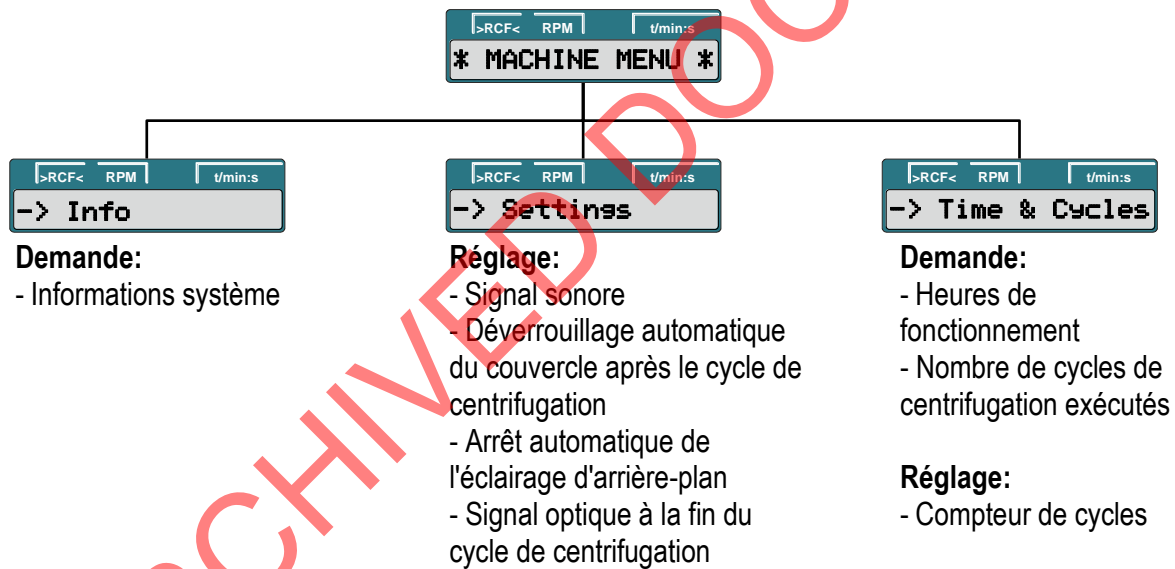

13.16 DEMANDER DES INFORMATIONS SUR LE SYSTEME

Vous pouvez demander les informations-système suivantes:

- Modèle d'appareil,
- Version du programme de l'appareil,
- Numéro du type de l'appareil,
- Date de fabrication de l'appareil,
- Numéro de série de l'appareil,
- • Type du convertisseur de fréquence,
- Version du programme du convertisseur de fréquence

Lorsque le rotor est à l'arrêt, procédez comme suit pour vos demandes d'informations: Vous pouvez à tout moment interrompre la procédure en appuyant la touche .

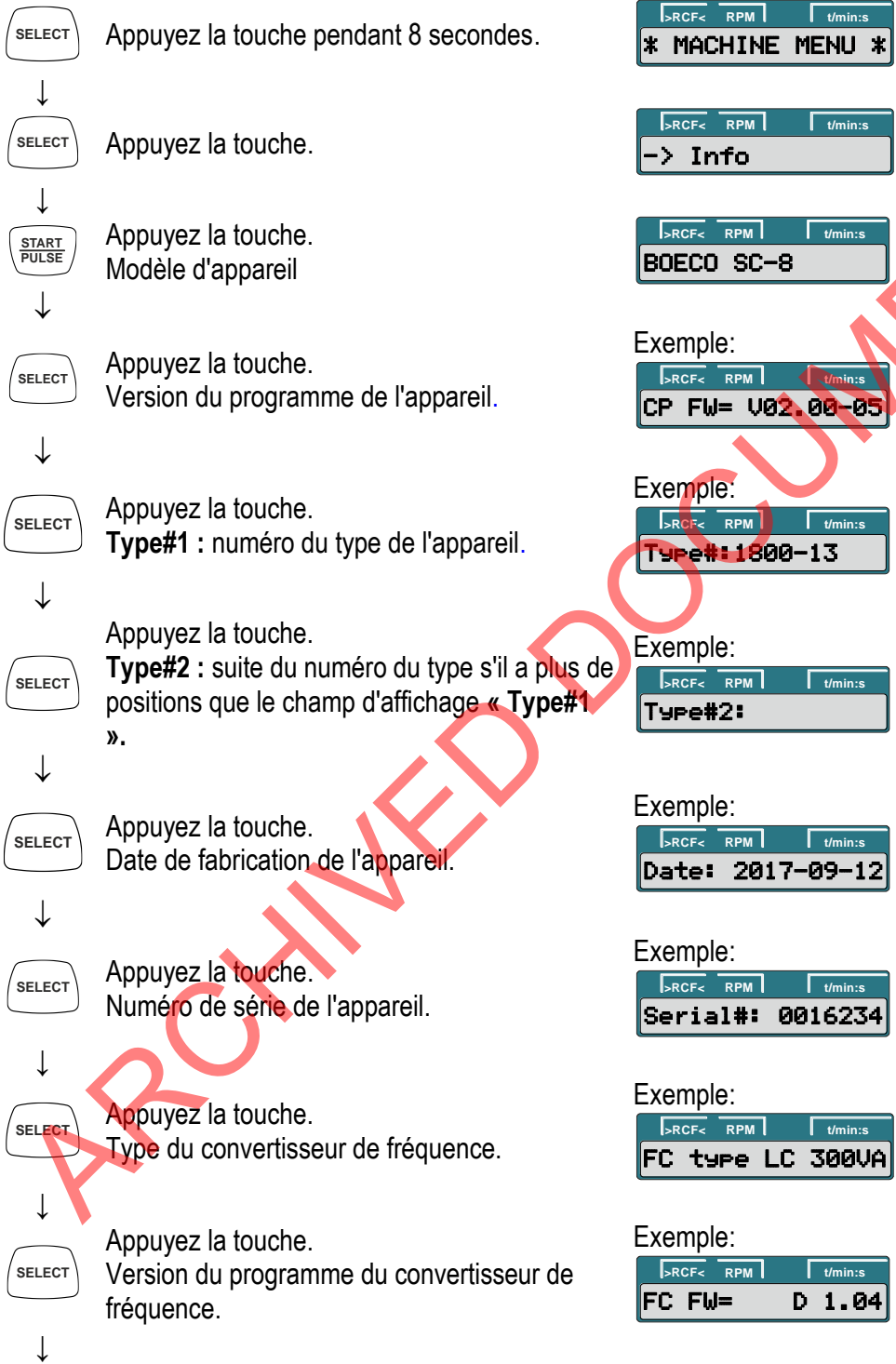



Appuyez deux fois la touche pour quitter le menu "-> Info" ou trois fois pour quitter le "* MACHINE MENU *".



Exemple:



13.17 SIGNAL SONORE

Le signal sonore retentit (1) en intervalles de 2 secondes en cas de dérangement. Et (2) en intervalles de 30 secondes une fois le cycle de centrifugation terminé et le rotor arrêté. Appuyez n'importe quelle touche pour arrêter le signal sonore. Lorsque le rotor est à l'arrêt, vous pouvez régler le signal sonore en

procédant comme suit. Vous pouvez à tout moment interrompre la procédure en appuyant la touche . Auquel cas, les réglages ne seront pas pris en compte.

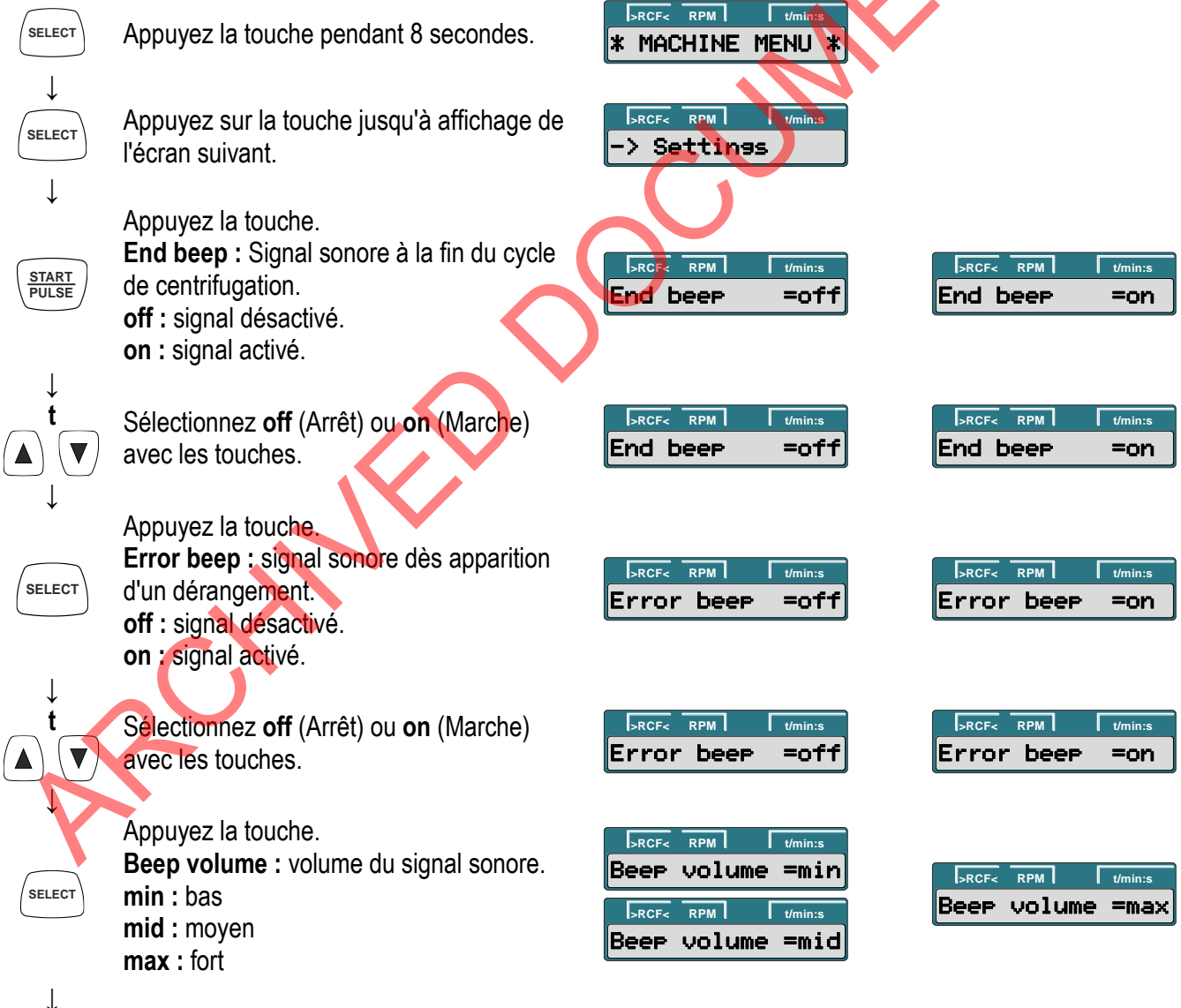

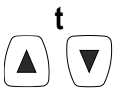

Sélectionnez **min**, **mid**, ou **max** avec les touches.

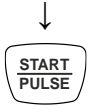

Appuyez la touche pour enregistrer le réglage.



Appuyez cette touche une fois pour quitter le menu "-> Settings" ou deux fois pour quitter le "* MACHINE MENU *".

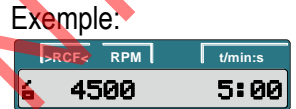

13.18 SIGNAL OPTIQUE A LA FIN DU CYCLE DE CENTRIFUGATION

A la fin du cycle de centrifugation, l'éclairage en arrière-plan de l'affichage clignote pour vous signaler optiquement que le cycle de centrifugation est terminé. Lorsque le rotor est à l'arrêt, vous pouvez activer ou désactiver le signal optique comme suit. Vous pouvez à tout moment interrompre la procédure en appuyant la touche .



Appuyez la touche pendant 8 secondes.

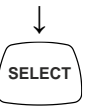

Appuyez sur la touche jusqu'à affichage de l'écran suivant.



Appuyez la touche.



Appuyez sur la touche jusqu'à affichage de l'un des deux écrans.



End blinking : clignotement de l'éclairage d'arrière-plan après le cycle de centrifugation.



off : l'éclairage d'arrière-plan ne clignote pas.

on : l'éclairage d'arrière-plan clignote.



Sélectionnez **off** (Arrêt) ou **on** (Marche) avec les touches.





Appuyez la touche pour enregistrer le réglage.



Appuyez cette touche une fois pour quitter le menu "-> Settings" ou deux fois pour quitter le "* MACHINE MENU *".



Exemple:



13.19 DEVERROUILLAGE AUTOMATIQUE DU COUVERCLE APRES LE CYCLE DE CENTRIFUGATION

Vous pouvez paramétrer si le couvercle doit se déverrouiller automatiquement ou pas après le cycle de centrifugation. Lorsque le rotor est à l'arrêt, vous pouvez procéder comme suit pour ce faire. Vous pouvez à tout moment interrompre la procédure en appuyant la touche . Auquel cas, les réglages ne seront pas pris en compte.



Appuyez la touche pendant 8 secondes.



Appuyez sur la touche jusqu'à affichage de l'écran suivant.



Appuyez la touche.



Appuyez sur la touche jusqu'à affichage de l'un des deux écrans.

Lid AutoOpen : déverrouillage automatique du couvercle après le cycle de centrifugation.

off : pas de déverrouillage automatique du couvercle.

on : déverrouillage automatique du couvercle.



Sélectionnez **off** ou **on** avec les touches.





Appuyez la touche pour enregistrer le réglage.



Appuyez cette touche une fois pour quitter le menu "-> Settings" ou deux fois pour quitter le "*MACHINE MENU*".



Exemple:



13.20 ECLAIRAGE D'ARRIERE-PLAN DE L'AFFICHAGE

Pour économiser de l'énergie, vous pouvez paramétrer si, après un cycle de centrifugation, l'éclairage d'arrière-plan de l'affichage doit s'éteindre au bout de 2 minutes. Lorsque le rotor est à l'arrêt, vous pouvez procéder comme suit pour ce faire. Vous pouvez à tout moment interrompre la procédure en appuyant la touche . Auquel cas, les réglages ne seront pas pris en compte.



Appuyez la touche pendant 8 secondes.



Appuyez sur la touche jusqu'à affichage de l'écran suivant.

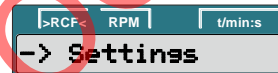

Appuyez la touche.



Appuyez sur la touche jusqu'à affichage de l'un des deux écrans:



Power save: arrêt automatique de l'éclairage d'arrière-plan.
off: arrêt automatique désactivé.
on: arrêt automatique désactivé.



Sélectionnez **off** (Arrêt) ou **on** (Marche) avec les touches.



Appuyez la touche pour enregistrer le réglage.





Appuyez cette touche une fois pour quitter le menu "-> Settings" ou deux fois pour quitter le "* MACHINE MENU *".



Exemple:



13.21 DEMANDER LES HEURES DE FONCTIONNEMENT ET LE NOMBRE DE CYCLES DE CENTRIFUGATION

Les heures de fonctionnement sont réparties en heures de service internes et externes. Heures de service internes : durée totale pendant laquelle l'appareil était enclenché. Heures de service externes : durée totale des cycles de centrifugation effectués jusque maintenant. Lorsque le rotor est à l'arrêt, procédez comme suit pour vos demandes d'informations. Vous pouvez interrompre à tout moment en appuyant

la touche .



Appuyez la touche pendant 8 secondes.

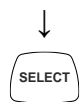

Appuyez sur la touche jusqu'à affichage de l'écran suivant.

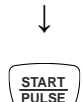
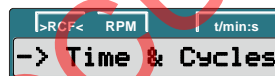

Appuyez la touche.
TimeExt: heures de service externes.

Exemple:

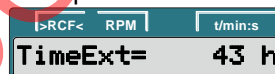

Appuyez la touche.
TimeInt: heures de service internes.

Exemple:

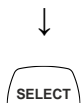

Appuyez la touche.
Starts: nombre total des cycles de centrifugation.

Exemple:

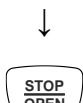

Appuyez la touche deux fois pour quitter le menu "-> Time & Cycles" ou trois fois pour quitter le "* MACHINE MENU *".

Exemple:

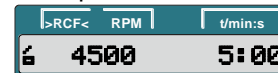

14 DEFAULTS

Si l'erreur ne peut pas être éliminée d'après le tableau des défauts, veuillez contacter le service client, et indiquer le type de centrifuge et le numéro de série. Les deux numéros sont indiqués sur la plaque signalétique de la centrifugeuse.



Effectuer une RÉINITIALISATION DU SECTEUR: Couper l'interrupteur de secteur (position de l'interrupteur « 0 »). Attendre au moins 10 secondes et refermer ensuite l'interrupteur de secteur (position de l'interrupteur « I »).

Message / Erreur		Origine	Solution
Pas d'affichage		Pas de tension Défaut des fusibles sur l'entrée de secteur.	<ul style="list-style-type: none"> – Vérifier l'alimentation en tension. – Vérifier les fusibles d'entrée du secteur et se référer aux instructions pour changer le fusible secteur. – Interrupteur du secteur sur MARCHÉ.
IMBALANCE		Le rotor est chargé de manière non symétrique.	<ul style="list-style-type: none"> – Ouvrez le couvercle lorsque le rotor est arrêté. – Vérifier le chargement du rotor. – Répéter le cycle de centrifugation.
MAINS INTER	11	Interruption du secteur pendant le cycle de centrifugation. (Le cycle de centrifugation n'est pas terminé.)	<ul style="list-style-type: none"> – Ouvrez le couvercle lorsque le rotor est arrêté. – Appuyer sur la touche start/pause. – En cas de besoin, répéter le cycle de centrifugation.
MAINS INTERRUPT			
TACHO ERROR	1, 2	Défaillance des impulsions de rotation pendant une opération.	<ul style="list-style-type: none"> – Effectuer une RÉINITIALISATION DU SECTEUR après l'immobilisation du rotor.
LID ERROR	4.1 – 4.127	Erreur du verrouillage ou de la fermeture du capot.	
OVER SPEED	5	Survitesse	<ul style="list-style-type: none"> – Effectuer une RÉINITIALISATION DU SECTEUR après l'immobilisation du rotor.
VERSION ERROR	12	Modèle de centrifugeuse détecté incorrect. Défaut / Panne de l'électronique	
UNDER SPEED	13	Vitesse trop basse	
CTRL ERROR	22.1, 25.2	Défaut / Panne de l'électronique.	
CRC ERROR	27.1		
COM ERROR	31 – 36		
FC ERROR	60, 61.1 – 61.21, 61.64 – 61.142		
FC ERROR	61.23	Vitesse de rotation mesurée erronée	
TACHO ERR	61.22		
FC ERROR	61.153	Défaut / Panne de l'électronique.	<ul style="list-style-type: none"> – Effectuer une RÉINITIALISATION DU SECTEUR. – Vérifier le chargement du rotor selon les instructions fournies. – Répéter le cycle de centrifugation.

15 ACCELERATION centrifuge relative (RCF)

L'accélération centrifuge relative (RCF) est indiqué en tant que multiple de l'accélération gravitationnelle (g). Il s'agit d'une valeur dépourvue d'unité, qui sert à la comparaison entre la puissance de séparation et de sédimentation. The relative centrifugal force (RCF) stands in relation to the revolutions per minute and the centrifugal radius. L'accélération centrifuge relative (RCF) est dépendante du régime et du rayon de centrifugation. Il peut être calculé en utilisant la formule suivante:

$$RCF = \left(\frac{RPM}{1000} \right)^2 \times r \times 1,118 \quad \Rightarrow \quad RPM = \sqrt{\frac{RCF}{r \times 1,118}} \times 1000$$

RCF = accélération centrifuge relative

RPM = régime

r = rayon de centrifugation en mm = distance qui sépare le centre de l'axe de rotation du fond de la cuve de centrifugation.

16 TRANSPORT ET STOCKAGE

Installer le dispositif de sécurité pour le transport avant de transporter l'appareil. Ne stocker l'appareil et ses accessoires que dans une pièce fermée au sec. Respecter les conditions ambiantes suivantes pour transporter ou stocker l'appareil et ses accessoires:

Température ambiante : -20 °C à +60 °C.

Humidité relative de l'air : 10 % à 80 %, non condensante.

17 CHANGER LES FUSIBLES D'ENTREE DE SECTEUR

Commencez par déclencher l'interrupteur de secteur et couper l'appareil du réseau. Le porte-fusible (A) avec les fusibles d'entrée de secteur se trouve à côté de l'interrupteur secteur. Retirer le câble de raccordement de la prise d'appareil. Appuyer la fermeture rapide (B) contre le porte-fusible (A) et extraire celui-ci. Remplacer les fusibles d'entrée de réseau défectueux. N'utilisez que des fusibles avec la valeur nominale, fixée pour le type de centrifugeuse fourni par le fabricant. Remettre en place le porte-fusible et pousser jusqu'à encastrement de la fermeture rapide. Rebrancher l'appareil sur le réseau.

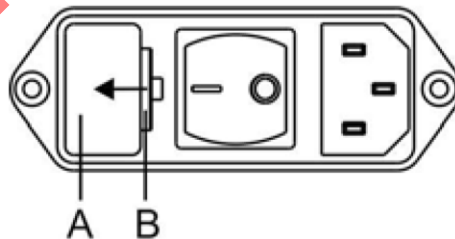

18 RENVOI D'APPAREILS AU FABRICANT

Avant de renvoyer l'appareil, il faut monter le dispositif de fixation pour le transport. Dans le cas où l'appareil ou ses accessoires doivent être retournés à la société légale, il faut les décontaminer et les nettoyer avant expédition, dans le but d'assurer la protection des personnes, de l'environnement et du matériel. La société légale réserve le droit de refuser des appareils ou des accessoires contaminés. Nous facturons au client les frais de nettoyage et de désinfection.

19 ÉLIMINATION DES DECHETS

Avant de mettre l'appareil au rebut, vous devez le décontaminer et le nettoyer pour la protection des personnes, de l'environnement et du matériel. Les dispositions légales en vigueur doivent être respectées lors de l'élimination de l'appareil. Conformément à la directive 2002/96/CE (WEEE), tous les appareils livrés après le 13.08.2005 ne doivent plus être jetés avec les déchets ménagers. L'appareil fait partie du groupe 8 (dispositifs médicaux) et est classé dans le domaine « Business-to-Business ».

Le symbole de la poubelle barrée d'une croix indique que l'appareil ne doit pas être jeté avec les déchets ménagers. Les dispositions relatives à l'élimination des déchets des différents pays peuvent varier. Veuillez-vous adresser en cas de besoin à votre fournisseur.

ARCHIVED DOCUMENT



La tabella dei simboli qui sotto è solo a scopo di riferimento. Fare riferimento all'etichetta della confezione del prodotto per i simboli applicabili.

Simbolo	Descrizione del simbolo
	Attenzione
	Istruzioni per l'uso elettroniche
	Produttore
	I prodotti BioHorizons recano il marchio CE e soddisfano i requisiti della Direttiva sui dispositivi medici 93/42/CEE
	Numero di riferimento/articolo
	Numero lotto/partita
	Non riutilizzare
	Non risterilizzare
	Data di scadenza
	Sterilizzato mediante irradiazione gamma
	Data di produzione
	Attenzione: la legge federale degli Stati Uniti limita la vendita, la distribuzione e l'uso di questi dispositivi ai soli medici o odontoiatri o su loro prescrizione

Simbolo	Descrizione del simbolo
	Posizione iniziale
	Non utilizzare se la confezione è danneggiata
	Dispositivo medico
	Non sterile
	Mantenere asciutto
	Fragile; maneggiare con cura
	Limiti di temperatura
	Questo lato in su
	Limiti di umidità
	Avvertimento; Rischio biologico
	Note importanti
	Raccolta separata di dispositivi elettrici ed elettronici.
	Rappresentante autorizzato dell'UE

1 INDICAZIONI PER L'USO

Il Sistema IntraSpin è destinato all'uso per la preparazione sicura e rapida di fibrina autologa ricca di piastrine (L-PRF), estratta da un piccolo campione di sangue presso il punto di cura (POC) del paziente. La L-PRF viene miscelata con l'autoinnesto e/o l'alloinnesto osseo prima dell'applicazione su un difetto osseo per migliorarne le caratteristiche di manipolazione. Anche l'osservazione di tutte le informazioni nelle Istruzioni per l'uso fa parte dell'uso previsto.

2 CONTROINDICAZIONI

La centrifuga IntraSpin è destinata esclusivamente allo scopo indicato nell'uso previsto del dispositivo. Qualsiasi altro utilizzo del dispositivo è considerato non previsto. L'uso della centrifuga IntraSpin è controindicato in presenza di una o più delle seguenti situazioni cliniche: pazienti con dipendenza da alcol o disturbi psichiatrici, discrasie ematiche, diabete incontrollato, ipertiroidismo, infezioni orali, neoplasie o pazienti che hanno avuto un infarto del miocardio negli ultimi 12 mesi. Pazienti con malattie sistemiche che compromettono il sistema immunitario, come l'AIDS, pazienti che assumono farmaci che potrebbero compromettere la guarigione di un sitoimplantare, pazienti con una storia di scarsa o non conformità alle procedure di igiene orale.

Pazienti che partecipano alla terapia anti-coagulante. Questi pazienti non sono esclusi dai benefici della PRF, ma il punto di cura deve aggiungere ulteriore tempo alla centrifuga affinché la separazione sia efficace per l'uso.



3 INDICAZIONI INERENTI LA SICUREZZA

- Se non vengono rispettate tutte le avvertenze riportate in queste istruzioni per il funzionamento, non può essere accettata da parte del produttore alcuna richiesta di garanzia.
- Le istruzioni per l'uso fanno parte del dispositivo. Devono sempre essere prontamente disponibili. Se il dispositivo è installato in una posizione diversa, è necessario fornire le istruzioni per l'uso.
- La centrifuga deve venire posizionata in modo sicuro.
- Prima di utilizzare la centrifuga, è necessario controllare che il rotore sia correttamente in sede.
- Durante un'operazione di centrifugazione, in una zona di sicurezza di 300 mm attorno alla centrifuga non deve sostare alcuna persona, materiali pericolosi ed oggetti, in conformità alle norme EN / IEC 61010-2-020.
- I rotori, le sospensioni e gli accessori che presentano forti segni di corrosione o danni meccanici, oppure la cui durata d'impiego è scaduta, non devono più essere utilizzati.
- Se il vano di centrifugazione presenta danni rilevanti per la sicurezza, la centrifuga non deve essere più messa in funzione.
- Nel caso di centrifughe senza regolazione termica, con temperature ambiente elevate e/o con frequente impiego dell'apparecchiatura può presentarsi un riscaldamento del vano di centrifugazione. Per questo motivo non può venire esclusa una sostituzione del campione a causa della temperatura.
- Prima di mettere in funzione la centrifuga si devono leggere ed osservare le istruzioni per l'uso. L'apparecchio può essere utilizzato solo da persone che abbiano letto e compreso le istruzioni d'uso.
- Oltre alle istruzioni per l'uso, si devono osservare anche i regolamenti, relativi alla protezione antinfortunistica ed i regolamenti tecnici, riconosciuti in materia di sicurezza del lavoro. Le istruzioni per l'uso vanno completate dalle norme nazionali in vigore nel paese d'impiego, relative alla protezione antinfortunistica ed alla tutela ambientale.
- Rientra nelle responsabilità dell'utente il rispetto degli standard specifici nazionali per la sicurezza del lavoro riguardanti l'impiego delle centrifughe ai posti di lavoro da lui previsti.

- La centrifuga è costruita in base all'attuale livello tecnologico e le regole di sicurezza conosciute. La centrifuga può essere tuttavia fonte di pericolo per l'operatore o per terzi, se non viene utilizzata da personale appositamente addestrato o se viene utilizzata in modo improprio o non conforme alla destinazione.
- Durante l'esercizio bisogna evitare di muovere la centrifuga o di urtarvi contro.
- In caso di guasto, ovvero del ripristino d'emergenza, non si deve assolutamente toccare il rotore.
- Quando la centrifuga passa da un ambiente freddo ad uno caldo, per evitare danni dovuti alla condensa, lasciar riscaldare la centrifuga per almeno 3 ore nell'ambiente caldo prima di collegarla alla rete, oppure portare la centrifuga a temperatura d'esercizio mettendola in funzione per 30 minuti nell'ambiente freddo.
- In caso di centrifugazione con massimo numero di giri, la densità dei materiali o delle miscele di materiali non deve superare il valore di composizione di 1,2 kg/dm³.
- Non è consentito l'uso della centrifuga se non bilanciata in modo regolare.
- Non è permesso l'impiego della centrifuga in ambiente a pericolo di esplosione.
- E' proibito l'uso di una centrifuga con: materiali infiammabili od esplosivi che possono reagire chimicamente tra loro con forte energia.
- Per questa centrifuga non sono disponibili sistemi di sicurezza biologici.
- Non è consentito il funzionamento della centrifuga con sostanze altamente corrosive che possono pregiudicare la resistenza meccanica dei rotori, delle sospensioni e degli accessori.
- Gli interventi di riparazione devono essere effettuati esclusivamente da una persona autorizzata dal produttore.
- Per offrire ai pazienti il massimo livello di sicurezza clinica, i prodotti Intra-Lock sono realizzati con materiali biocompatibili con il plasma umano.
- Questo prodotto non è autorizzato per la vendita in tutti i mercati e potrebbe non essere disponibile nel vostro mercato. Per ulteriori informazioni, rivolgersi al rappresentante Intra-Lock locale.

4 COMPONENTI DEL SISTEMA INTRASPIN

COMPONENTE	QUANTITÀ PER SISTEMA
Centrifuga IntraSpin incluso:	1
Cavo di alimentazione	1
Fusibile	2
Chiave esagonale	1
Greiner Provette per il prelievo ematico e provette di bilanciamento (monouso).	150
Greiner Safety Blood Collection Set + Holder, 21G (monouso)	24
Laccio emostatico senza lattice	1
Portaprovette	1
Forbici chirurgiche curve	1
Pinza per tessuti chirurgici	1
Vaschetta rotonda in acciaio inossidabile	1
Vaschetta rettangolare in acciaio inossidabile	1
Spatola portante doppio biomateriale	1
Doppia confezione di biomateriale	1
Contenitore Xpression®	1

Sono raccomandati e garantiti solo componenti compatibili verificati per l'uso diretto con la centrifuga IntraSpin.:

PARTE COMPATIBILE #	DESCRIZIONE
455092	Attivatore del coagulo di siero da 9 ml CAT, tappo rosso
455001	Tappo bianco 9 ml Z provetta senza additivi
BHEXZ (E613)	Chiave esagonale IntraSpin, 110 V e 220 V
BROTORZ (E3694)	Rotore IntraSpin, 100v e 220v
BPOWER110Z (E1673)	Cavo di alimentazione IntraSpin, 110v
BPOWER220Z (E1669)	Cavo di alimentazione IntraSpin, 220v
BTUBEHOLDZ (E872 x 1)	Sostituzione del supporto del tubo IntraSpin
BFUSE110Z (E997)	Fusibile IntraSpin 110v
BFUSE220Z (E891)	Fusibile IntraSpin 220v

5 BREVE IMPOSTAZIONE CENTRIFUGA

Rimuovere e conservare i bulloni di trasporto dal fondo della centrifuga.

Collegare il cavo CA e la spina alla presa elettrica.

Accendere la centrifuga utilizzando l'interruttore sul retro del dispositivo.

Selezionare velocità e tempo: Velocità = 2700 & Tempo = 12:00 min.

Premere START (AVVIO).

Il coperchio della centrifuga si aprirà automaticamente al termine di ogni ciclo.

Dopo la prima procedura, la temporizzazione e la velocità vengono registrate nella memoria della centrifuga a meno che non vengano modificate le impostazioni.

6 ISTRUZIONI E PRECAUZIONI PER LE PROVETTE PER IL PRELIEVO EMATICO E IL SET PER IL PRELIEVO EMATICO

- Non utilizzare le provette se sono presenti corpi estranei.
- Le provette per il prelievo ematico devono essere riempite completamente.
- Maneggiare tutti i campioni biologici e gli oggetti taglienti per il prelievo di sangue (ad es., aghi e set per il prelievo ematico) secondo le politiche e le procedure della propria struttura.
- Non piegare l'ago.
- Non rilasciare o riattivare con forza il meccanismo di sicurezza dell'ago dopo che è stato attivato.
- Richiedere un'adeguata assistenza medica in caso di esposizione a campioni biologici (ad es. Attraverso lesioni da puntura) a causa della possibile trasmissione di HIV (AIDS), epatite virale o altre malattie infettive.
- Eliminare tutti gli "oggetti taglienti" della raccolta sangue in contenitori a rischio biologico dedicati.
- Il trasferimento di un campione da una siringa in una provetta non è una procedura consigliata.
- Se il sangue viene raccolto attraverso una linea endovenosa (IV), seguire le linee guida e le procedure del proprio istituto per assicurarsi che la linea sia stata eliminata dalla soluzione endovenosa prima di iniziare a riempire i tubi di raccolta del sangue.
- L'accelerante della coagulazione del sangue può apparire bianco sulla superficie del tubo, il che non ha alcun effetto sulle prestazioni dei tubi. Se nel tubo sono presenti altri scolorimenti o precipitati, non devono essere utilizzati.
- Non utilizzare le provette dopo la data di scadenza.
- Conservare le provette per il prelievo ematico a 4-25 °C (40-77 °F).

- Conservare il set per il prelievo ematico (ago e supporto) a 4-36 °C (40-97 °F).
- Evitare l'esposizione alla luce solare diretta. Il superamento della temperatura di conservazione massima consigliata può comportare una compromissione della qualità del tubo (ad es. Perdita di vuoto, colorazione, ecc.).
- Per evitare il reflusso, posizionare il braccio del paziente in una posizione verso il basso, tenere la provetta con il cappuccio rivolto verso l'alto, rilasciare il laccio emostatico non appena il sangue inizia a fluire nella provetta, evitare che il contenuto della provetta entri in contatto con il cappuccio o l'estremità dell'ago durante prelievo venoso.
- Accertarsi che i seguenti materiali siano facilmente accessibili prima di eseguire il prelievo venoso: tutte le provette necessarie per la raccolta del sangue, etichette identificate per l'identificazione positiva dei campioni dei pazienti, aghi e supporti per la raccolta del sangue, tampone imbevuto di alcool per la pulizia del sito di puntura, garza pulita, laccio emostatico, cerotto adesivo o bendaggio, contenitore per rischio biologico approvato. Per la protezione dall'esposizione ad agenti patogeni ematici, si raccomanda l'uso di DPI (dispositivi di protezione individuale) adeguati (ad es. Guanti, camice da laboratorio, occhiali, ecc.).

Tecnica di prelievo venoso e prelievo del campione ematico:

La raccolta del sangue deve essere effettuata il più rapidamente possibile, poiché non c'è anticoagulante nelle provette di raccolta. Il campione di sangue inizierà a coagulare immediatamente. Indossare guanti durante il prelievo venoso e quando si maneggiano le provette per la raccolta del sangue per ridurre al minimo il rischio di esposizione. Prima del prelievo del sangue, pulire la parte superiore del tappo (i) della provetta di sangue con un panno disinfettante a scelta. Rimuovere il coperchio sopra la sezione della valvola dell'ago. Preparare il sito di prelievo con un antisettico appropriato. Non palpare l'area di prelievo dopo la pulizia. Posizionare il braccio del paziente verso il basso. Rimuovere la protezione dell'ago. Eseguire il prelievo venoso con il braccio verso il basso e il tappo del tubo più in alto. Immobilizzare l'ago con del nastro adesivo, se necessario. Spingere il tubo di raccolta del sangue nel supporto e sulla valvola a spillo perforando il diaframma di gomma del tubo di raccolta del sangue. Centrare le provette per la raccolta del sangue nel supporto quando si penetra nel tappo per impedire la penetrazione della parete laterale e la conseguente perdita prematura del vuoto. Rimuovere il laccio emostatico non appena il sangue appare nel tubo di raccolta del sangue. Durante la procedura, tenere sempre in posizione il tubo di raccolta premendolo con un pollice. Ciò garantirà un completo assorbimento del vuoto. Il tubo di raccolta del sangue si riempirà automaticamente. Se non scorre sangue nella provetta di raccolta o se il flusso sanguigno cessa prima che venga raccolto un campione adeguato, si suggerisce di completare una raccolta soddisfacente:

- Spingere in avanti il tubo di raccolta del sangue per assicurarsi che il tappo sia penetrato.
- Confermare la posizione corretta dell'ago nella vena.
- Se il sangue continua a non scorrere, rimuovere ed eliminare in modo appropriato la provetta di raccolta. Ottenere un nuovo tubo di raccolta e spingere nel supporto.
- Se il secondo tubo di raccolta non si attira, rimuovere e gettare in modo appropriato l'ago e il tubo di raccolta. Ripeti la procedura.
- Quando è stata raggiunta la linea di riempimento del volume massimo della base del tubo di raccolta del sangue, rimuoverla delicatamente dal supporto. Ripetere con una seconda provetta per la raccolta del sangue.

Capovolgere delicatamente ciascun tubo di raccolta immediatamente dopo averlo rimosso dal supporto. Non agitare le provette piene di campione di sangue. Una miscelazione intensa può causare schiuma o emolisi. Una miscelazione insufficiente o una miscelazione ritardata in provette di siero possono causare una coagulazione ritardata.

Al termine del ritiro del campione ematico, rimuovere l'ago dalla vena. Attivare il meccanismo di sicurezza (protezione di sicurezza) dell'ago premendo su entrambi i lati del mozzo per innestarlo nel raccordo. Far scorrere all'indietro il meccanismo di sicurezza fino a sentire un clic. Non reincappucciare l'ago, in quanto ciò aumenta il rischio di lesioni da punture di ago ed esposizione al sangue. Smaltire l'ago usato con il relativo supporto utilizzando un contenitore adatto per lo smaltimento dei rifiuti biologici. Applicare una pressione sul sito di puntura con un bastoncino sterile asciutto fino a quando l'emorragia si arresta. Se lo si desidera, applicare una benda una volta avvenuta la coagulazione. Si consiglia di tenere i tubi di raccolta riempiti in posizione verticale. Una volta che la seconda provetta è piena, rimuoverla e posizionare entrambe le provette nella centrifuga in posizione opposta per controbilanciare il rotore, chiudere il coperchio della centrifuga IntraSpin® e premere il pulsante "START" (AVVIO) per consentire la centrifugazione per 12 MINUTI.

Se sono necessarie più di due provette di sangue, seguire questa procedura alternativa: dopo aver prelevato e capovolto delicatamente le prime due provette, posizionarle immediatamente nella centrifuga IntraSpin, una di fronte all'altra, per assicurarsi che la centrifuga sia adeguatamente bilanciata. Chiudere il coperchio e premere il pulsante START e consentire alla centrifuga di funzionare mentre si raccolgono le rimanenti provette di sangue. Premere il pulsante STOP e consentire alla centrifuga di arrestarsi completamente. Il coperchio si aprirà; posizionare immediatamente le rimanenti provette nella centrifuga l'una di fronte all'altra per garantire un corretto bilanciamento e premere il pulsante START per ripristinare e completare il protocollo raccomandato.

Collocare sempre le provette in coppia posizionandole l'una opposta all'altra, in modo da bilanciare il rotore della centrifuga e provette devono essere sempre bilanciate nel rotore prima di premere il pulsante START (AVVIO), per evitare gravi danni alla centrifuga e una coagulazione e/o una separazione inadeguate. Se le provette non sono adeguatamente bilanciate, ci saranno troppe vibrazioni durante la centrifugazione e si otterrà un cattivo coagulo di fibrina L-PRF.

In caso di un numero dispari di campioni di sangue da centrifugare, posizionare nel rotore una provetta di bilanciamento con tappo bianco (ad es. 455001), riempita con acqua fino alla linea di riempimento indicata, di fronte alla provetta non accoppiata. Ciò consentirà il corretto bilanciamento della centrifuga.

Iniziare la centrifugazione subito dopo aver raccolto i campioni ematici. I ritardi influenzano la procedura di separazione del sangue e causano un cattivo coagulo di fibrina L-PRF.

7 PREPARAZIONE DELL'L-PRF

Dopo la centrifugazione, sono visibili tre segmenti:

1. Segmento superiore = plasma povero di piastrine (PPP).
2. Segmento centrale = coagulo di fibrina: L-PRF.
3. Segmento inferiore = coagulo di globuli rossi.

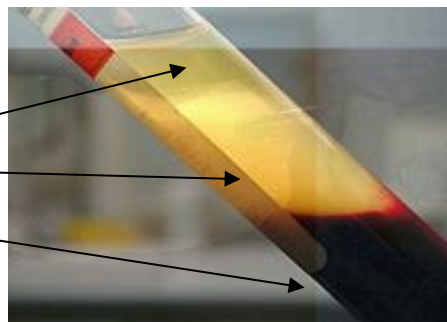

Le membrane o i tappi di fibrina L-PRF devono essere preparati in modo relativamente rapido: 0-15 minuti dopo la centrifugazione, altrimenti il coagulo si ridurrà di volume rilasciando il siero intrappolato. Dopo la centrifugazione rimuovere il tappo di gomma da ciascuna provetta. Usando una pinzetta chirurgica rimuovere il coagulo L-PRF dal tubo. Raschiare delicatamente il coagulo di globuli rossi dal coagulo di fibrina L-PRF® appena sotto l'unione, usando la spatola portante biomateriale doppia, in modo che solo una minima quantità residua di globuli rossi sia attaccata al coagulo L-PRF. Posizionare il coagulo di fibrina sul vassoio perforato Xpression.

8 PREPARAZIONE DELLA MATRICE DI FIBRINA

Protocollo N. 1 L-PRF Membrana

Posizionare ciascuno dei coaguli di fibrina sul vassoio perforato Xpression. Una volta posizionati tutti i coaguli di fibrina, posizionare la placca di compressione Xpression e il coperchio pesato Xpression sui coaguli di fibrina senza esercitare alcuna pressione sui coaguli.

Lasciare che il peso del coperchio PREMA lentamente sui coaguli di fibrina mentre l'essudato viene filtrato sul fondo del vassoio. Non applicare pressione sul coperchio pesato. La forza gravitazionale sul coperchio a pressione comprimerà delicatamente il coagulo spremendo il siero dal coagulo di PRF senza danneggiare la rete di fibrina.

Attendere almeno 5 minuti prima di rimuovere e utilizzare eventuali membrane di fibrina. Non rimuovere le membrane di fibrina fino al momento effettivo dell'uso. La membrana di fibrina può rimanere nella Contenitore Xpression per un periodo massimo di 3 ore.



Protocollo N. 2 Spina L-PRF

Posizionare un coagulo di fibrina all'interno del cilindro di fabbricazione del tappo bianco. Utilizzare il pistone per premere lentamente il coagulo all'interno del cilindro bianco di fabbricazione del tappo L-PRF. Continuare a premere fino a quando il bordo superiore del pistone è a filo con il bordo superiore del cilindro bianco di fabbricazione del tappo L-PRF. Con questa tecnica, si sarà in grado di formare un cilindro di fibrina spesso e rotondo per un alveolo estrattivo. Per un singolo dente, può essere sufficiente un cilindro L-PRF. I pre-molari potrebbero necessitare di due cilindretti L-PRF®, mentre per i molari potrebbero occorrerne tre, a seconda delle dimensioni dell'alveolo estrattivo e del coagulo di fibrina creato.

Le proprietà di lavoro dell'L-PRF® lo rendono un mezzo eccellente, se utilizzato in combinazione con il biomateriale di preferenza. Utilizzando uno dei seguenti protocolli di miscelazione, il biomateriale viene catturato nella matrice di fibrina, aumentandone la maneggevolezza e la capacità biologica.

Protocollo N. 3- Miscela di biomateriale / L-PRF

Per creare una miscela “tipo stucco”, da modellare delicatamente con lo strumento per biomateriale fino a darle la forma e lo spessore desiderati, attenersi al seguente protocollo: Tagliare delicatamente la membrana di fibrina L-PRF in piccoli pezzi in un piatto sterile con le forbici chirurgiche curve. Aggiungere la quantità desiderata di materiale per innesto osseo. Miscelare accuratamente l'L-PRF® e il materiale per innesto osseo. Questa miscela può essere collocata in difetti usando la Spatola portante biomateriale doppia.



Protocollo N. 4- Miscela di biomateriale / matrice L-PRF

Posizionare la quantità predeterminata di materiale per innesto osseo in una ciotola sterile o un vassoio. Immergere uno o più membrane L-PRF® spremute o parti di una membrana L-PRF® nel materiale d'innesto coprendo l'intera superficie della membrana L-PRF® con materiale di innesto. In alternativa, il materiale d'innesto può essere spruzzato sulla membrana L-PRF® fino a coprirne l'intera superficie. Nota: una membrana L-PRF® più umida può trattenere una quantità leggermente maggiore di materiale per innesto rispetto a una membrana PRF asciutta. Il materiale dell'innesto dovrebbe aderire alla superficie dell'L-PRF, tuttavia, se lo si desidera, premere delicatamente il materiale dell'innesto sulla membrana dell'L-PRF. Le pinze chirurgiche per tessuto possono essere utilizzate per posizionare questa miscela nel difetto.

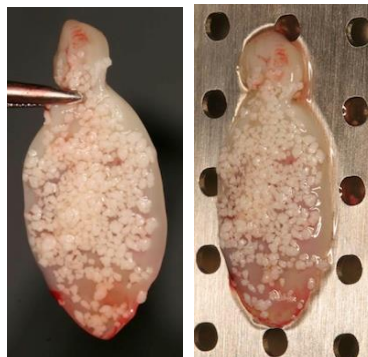

Protocollo N. 5- Idratazione biomateriale

Aggiungere la quantità desiderata di materiale per innesto osseo in una ciotola o vassoio sterile. Utilizzare l'essudato dal fondo del vassoio di raccolta Xpression per idratare il materiale da innesto. Mescolare accuratamente il materiale essudato e l'innesto osseo. Questa miscela può essere collocata in difetti usando la Spatola portante biomateriale doppia.

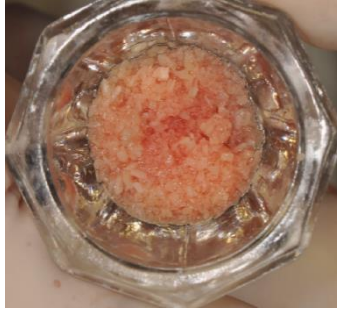

9 PULIZIA E STERILIZZAZIONE DEL KIT DI RIGENERAZIONE DEI TESSUTI

Il contenitore Xpression® consente una facile produzione di membrane di fibrina di spessore costante. L'essudato può essere raccolto dal vassoio di raccolta Xpression, sotto il vassoio perforato Xpression. Il Contenitore Xpression include supporti per la realizzazione dei cilindri L-PRF e un pistone per cilindri che si adatta facilmente agli alveoli post-estrattivi.



Coperchio pesato Xpression



Placca di compressione Xpression



Vassoio perforato Xpression nel vassoio della raccolta Xpression

Il Contenitore Xpression e gli strumenti ausiliari NON sono forniti sterili. Rimuovere ed eliminare il materiale di spedizione prima della sterilizzazione iniziale. Pulire e sterilizzare il Contenitore Xpression e gli strumenti ausiliari prima di ogni utilizzo.

Smontare la scatola di compressione prima di ogni ciclo di pulizia e sterilizzazione per evitare incapsulamento di detriti, scolorimento del materiale e / o asciugatura inadeguata dei componenti. I cilindri di fabbricazione del tappo L-PRF e l'alloggiamento in gomma del pistone non devono essere rimossi dal vassoio perforato Xpression per la pulizia e la sterilizzazione.

Pulizia: (1) Rimuovere eventuali detriti visibili dai componenti del Contenitore Xpression e dagli strumenti ausiliari usando una spazzola a setole morbide e un detergente ad ampio spettro per la pulizia o la disinfezione come Enzymax® di Hu-Friedy o equivalente. Risciacquare abbondantemente. (2) Posizionare i componenti

del Contenitore Xpression e gli strumenti ausiliari in un contenitore di dimensioni adeguate della stessa soluzione e metter a bagno di ultrasuoni per 10 minuti. Risciacquare abbondantemente. (3) Risciacquare i componenti della Xpression Box e gli strumenti ausiliari con alcool isopropilico per rimuovere eventuali residui di sapone e minerali. (4) Asciugare i componenti del Contenitore Xpression e gli strumenti ausiliari con un asciugamano privo di lanugine e asciugare completamente all'aria. Fare riferimento all'etichetta del detergente usato per le istruzioni per l'uso.

Sterilizzazione: (1) Posizionare il Contenitore Xpression riassembleato e gli strumenti ausiliari in un sacchetto o involucri di sterilizzazione approvato dalla FDA. (2) Eseguire uno dei seguenti cicli di sterilizzazione qualificati:

Metodo di sterilizzazione	Temperatura	Tempo Di Esposizione	Tempo Minimo Di Asciugatura
Vapore pre-vuoto (ANSI/AAMI ST79)	132°C (270°F)	4min	20-30 minuti
Vapore pre-vuoto (UK DoH Health Technical Memorandum 01-01)	134°C (273°F)	3min	20-30 minuti

Attenzione! Una pulizia impropria può comportare una sterilizzazione inadeguata. La mancata asciugatura completa dei componenti della Xpression Box e degli strumenti ausiliari durante la sterilizzazione in autoclave può lasciare umidità e causare scolorimento e ossidazione. L'uso di perossido di idrogeno o altri agenti ossidanti danneggerà la superficie dei componenti della Xpression Box e degli strumenti ausiliari. Si consiglia di testare periodicamente, pulire e calibrare le apparecchiature dell'autoclave per garantire che l'unità rimanga in condizioni operative adeguate.

10 PULIZIA E MANUTENZIONE CENTRIFUGA

L'apparecchiatura può essere contaminata. Prima della pulizia, staccare la presa di corrente. Centrifughe, rotor e accessori non devono essere lavati in lavastoviglie. Si deve eseguire solo una pulizia manuale ed una disinfezione con liquido. La temperatura dell'acqua deve essere di 20 – 25 °C. Possono essere usati solo detersivi / disinfettanti con un pH compreso tra 5 e 8 e che non contengono alcali caustici, perossidi, composti del cloro, acidi e soluzioni alcaline. Seguire attentamente le indicazioni speciali del produttore sull'impiego di detersivi e disinfettanti, al fine di evitare qualsiasi fenomeno di corrosione.

Pulire regolarmente il corpo della centrifuga e la camera di centrifugazione e impiegare all'occorrenza sapone o un detergente delicato e un panno umido per prevenire la corrosione attraverso impurità aderenti. Ingredienti dei detersivi adatti includono sapone, tensioattivi anionici e tensioattivi non ionici. Dopo l'impiego di detersivi, rimuovere i resti del detergente pulendo di nuovo con un panno umido. Le superfici devono essere asciugate subito dopo la pulizia. In caso di formazione di acqua di condensa, asciugare la camera di centrifugazione pulendola con un panno assorbente. Spalmare sulla guarnizione di gomma della camera di centrifugazione, frizionando leggermente, talco in polvere o una sostanza per la cura della gomma. Controllare se il vano di centrifugazione presenta danneggiamenti. Se vengono stabiliti danni rilevanti per la sicurezza, la centrifuga non deve essere più messa in funzione. In questo caso si deve contattare il servizio assistenza clienti.

Per la disinfezione delle superfici, in presenza di materiale infettivo nella camera di centrifugazione si deve disinfettarla immediatamente. Ingredienti dei disinfettanti adatti includono etanolo, alcol n proclitico, etilexanolo, tensioattivi anionici e inibitori di corrosione. Dopo l'impiego di disinfettanti, rimuovere i resti del disinfettante pulendo di nuovo con un panno umido. Le superfici devono essere asciugate subito dopo la disinfezione.

Per la rimozione di contaminanti radioattivi, la sostanza deve essere certificata in modo speciale per rimuovere contaminazioni radioattive. Ingredienti di sostanze adatte alla rimozione di contaminazioni radioattive includono tensioattivi anionici, tensioattivi non ionici, etanolo polidratato. Dopo aver rimosso le contaminazioni radioattive, rimuovere i resti della sostanza pulendo di nuovo con un panno umido. Le superfici devono essere asciugate, subito dopo la rimozione delle contaminazioni radioattive.

11 PULIZIA E MANUTENZIONE ROTORE E ACCESSORI

Per prevenire corrosione e modifiche dei materiali il rotore e gli accessori devono essere regolarmente puliti con sapone o con un detergente delicato e con un panno umido. Si consiglia la pulizia almeno una volta la settimana. La sporcizia deve essere subito rimossa.

Ingredienti dei detergenti adatti includono sapone, tensioattivi anionici e tensioattivi non ionici. Dopo l'impiego di detergenti, rimuovere i resti del detergente, risciacquando con acqua (solo al di fuori della centrifuga) o ripulendo con un panno umido. Il rotore e l'accessorio devono essere asciugati immediatamente dopo il lavaggio. Il rotore e gli elementi accessori devono essere verificati settimanalmente per quanto riguarda il loro stato di usura ed i danneggiamenti da corrosione. Quando si rilevano segni di usura o di corrosione, non utilizzare più il rotore e i pezzi accessori. Verificare settimanalmente la posizione del rotore. Se del materiale infetto viene a contatto con il rotore o con gli accessori, allora si deve eseguire una disinfezione adeguata.

Ingredienti dei disinfettanti adatti includono etanolo, alcol n proclitico, etilexanolo, tensioattivi anionici e inibitori di corrosione. Dopo l'impiego di disinfettanti, rimuovere i resti del disinfettante, risciacquando con acqua (solo al di fuori della centrifuga) o ripulendo con un panno umido. Il rotore e gli accessori devono essere asciugati immediatamente dopo la disinfezione.

Per la rimozione di contaminanti radioattivi, la sostanza deve essere certificata in special modo per rimuovere contaminazioni radioattive. Ingredienti di sostanze adatte alla rimozione di contaminazioni radioattive includono tensioattivi anionici, tensioattivi non ionici ed etanolo poliidratato. Dopo la rimozione delle contaminazioni radioattive, rimuovere la sostanza, risciacquando con acqua (solo al di fuori della centrifuga) o ripulendo con un panno umido. Il rotore e gli accessori devono venire asciugati subito dopo la rimozione delle contaminazioni radioattive.

Il rotore può essere trattato in autoclave a 121 °C / 250 °F per 20 minuti e asciugato in modo appropriato. Dopo 10 trattamenti in autoclave, per motivi di sicurezza il rotore deve venire sostituito. La sterilizzazione in autoclave accelera il processo di invecchiamento della plastica e può causare scolorimento. Dopo la sterilizzazione in autoclave, attendere che il rotore si sia raffreddato a temperatura ambiente prima di riutilizzarlo. Per quanto riguarda il grado di sterilizzazione non può essere citato alcun dato.

Il periodo di utilizzo del rotore è limitato a 50.000 cicli di funzionamento (cicli di centrifugazione) o 5 anni, a seconda dell'evento che si verifica per primo. La quantità massima ammessa dei cicli operativi è visibile sul rotore. Per motivi di sicurezza l'impiego del rotore non è più ammesso, quando è stato raggiunto il numero di cicli consentiti riportato su di esso. L'apparecchiatura è dotata di un contatore di cicli, che conteggia i cicli operativi (operazioni di centrifugazione).

In caso di frattura del tubo sanguigno, tutte le parti rotte e il sangue devono essere completamente rimossi. La centrifuga deve essere accuratamente pulita come indicato e gli inserti in gomma nonché i manicotti in plastica del rotore devono essere sostituiti.

12 DATI TECNICI CENTRIFUGA

Tipo di modello	IS220Z	IS110Z
Tensione di rete ($\pm 10\%$)	200 - 240 V 1~	100 - 127 V 1~
Frequenza di rete	50 - 60 Hz-	50 - 60 Hz
Potenza assorbita	100 VA	100 VA
Assorbimento di corrente	0.5 A	1.0 A
Capacità	8 x 10 ml	
Densità massima permessa	1.2 kg/dm ³	
Regime di rotazione massima (RPM)	6,000	
Accelerazione (RCF)	3,461	
Energia cinetica	750 Nm	
luogo di installazione	Solo in interni	
Altezza	Fino a 2000 metri sopra il livello del mare	
Temperatura ambiente per il funzionamento	5°C fino 40°C	
Umidità relativa per il funzionamento	Umidità relativa massima dell'aria 80% per temperature fino a 31 °C, con riduzione lineare fino al 50% dell'umidità relativa	
Categoria di sovratensione	II	
Grado di imbrattamento	2	
Classe di protezione	I	
	Non adatto per l'impiego in ambiente a rischio di esplosione.	
Emissione di radiointerferenze resistenza	EN / IEC 61326-1, Class B	FCC Class B
Livello di emissione acustica (in funzione del rotore)	≤ 50 dB(A)	
Larghezza della centrifuga	261 mm	
Profondità di centrifuga	353 mm	
Altezza della centrifuga	228 mm	
Peso della centrifuga	ca. 9 kg	

13 ISTRUZIONI PER L'USO DELLA CENTRIFUGA

È indispensabile rimuovere il dispositivo di fissaggio per il trasporto, composto da 2 viti (a) e 2 distanziali (b). Conservare il dispositivo di sicurezza per il trasporto, poiché prima di un ulteriore trasporto deve venire reinstallato. Il trasporto dell'apparecchiatura è ammesso solo con dispositivo di sicurezza per il trasporto installato. Per proteggere l'apparecchiatura durante il trasporto, il motore viene fissato. Questo dispositivo di sicurezza per il trasporto deve venire rimosso al momento della messa in esercizio dell'apparecchiatura.

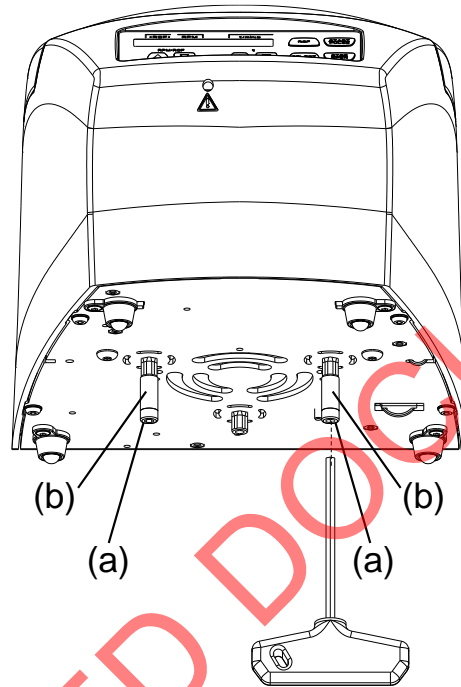

13.1 MESSA IN FUNZIONE

- Rimuovere il dispositivo di sicurezza per il trasporto dal lato inferiore della centrifuga.
- Porre la centrifuga in un posto adatto e livellarla. Durante un'operazione di centrifugazione, in una zona di sicurezza di 300 mm attorno alla centrifuga non deve sostare alcuna persona, materiali pericolosi ed oggetti.
- Gli sfoghi di ventilazione non devono essere chiusi mettendo oggetti davanti. Rispetto alle feritoie di ventilazione e alle aperture di ventilazione della centrifuga deve essere mantenuta una distanza di 300 mm.
- Verificare se la tensione di rete sia adatta all'indicazione riportata nella targhetta con i dati caratteristici.
- Collegare la centrifuga ad una presa di rete standard utilizzando un cavo di rete.
- Inserire l'interruttore di rete.
- Sul pannello vengono visualizzati i seguenti display: il tipo di modello di centrifuga, la versione del software e gli ultimi dati di centrifugazione utilizzati.
- Quando il coperchio è chiuso, viene esposto il messaggio "Open the lid". In questo caso aprire il coperchio, in modo che i dati di centrifugazione vengano esposti.

13.2 APERTURA E CHIUSURA DEL COPERCHIO DELLA CENTRIFUGA

Il coperchio si lascia aprire solo quando la centrifuga è inserita ed il rotore è fermo. Quando il contatore cicli è attivato, dopo ogni operazione di centrifugazione e durante l'apertura del coperchio, viene esposta per breve tempo la quantità residua di cicli operativi (operazioni di centrifugazione).

Esempio: 

Per aprire il coperchio, premere il tasto seguente



. Il coperchio si sblocca meccanicamente. 

Esempio: 

Non intervenire con le dita tra il coperchio e l'alloggiamento. Non chiudere con violenza il coperchio.

Per chiudere il coperchio, premere leggermente verso il basso il bordo anteriore del coperchio.  indica il coperchio bloccato.

Esempio: 

13.3 SBLOCCAGGIO DI EMERGENZA

Nel caso di interruzione di servizio della corrente il coperchio non può essere sbloccato meccanicamente. Deve essere eseguito uno sbloccaggio di emergenza di tipo manuale. Per sbloccare in caso di emergenza, spegnere l'interruttore di rete (posizione di interruttore "0"). Guardare dalla finestra che si trova sul coperchio per assicurarsi che il rotore sia fermo. Aprire il coperchio solo a rotore fermo. Introdurre orizzontalmente nel foro (A) la chiave a brugola esagonale e girare con cautela in senso antiorario (verso sinistra), fino a quando il coperchio si apre. ATTENZIONE! Ruotando la chiave a brugola esagonale in senso orario (verso destra) si potrebbe danneggiare il sistema di bloccaggio. Estrarre poi la chiave a brugola esagonale dal foro.

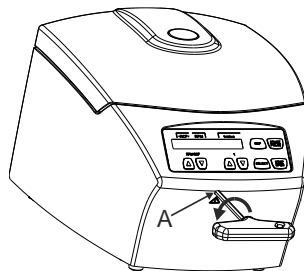

13.4 MONTAGGIO E SMONTAGGIO DEL ROTORE

Per rimuovere il rotore, sbloccare, girandolo in senso antiorario con la chiave a brugola esagonale, il dado di bloccaggio del rotore e girare fino al punto di pressione di sollevamento. Dopo aver superato il punto di pressione di sollevamento il rotore si sblocca dal cono dell'albero motore. Girare il dado di bloccaggio, fino a quando il rotore si lascia sollevare dall'albero motore. Sollevare il rotore dall'albero motore.

Per installare il rotore, pulire l'albero motore (A) ed il foro del rotore ed ingrassare poi leggermente l'albero motore. Le particelle di sporco tra l'albero motore ed il rotore impediscono un perfetto posizionamento in sede del rotore e sono causa di un irrequieto movimento. Applicare verticalmente il rotore sull'albero motore. Al momento dell'applicazione del rotore, la barra di contrassegno (B) sul rotore, deve essere parallela ad entrambe le superfici (C) dell'albero motore. Serrare il dado di bloccaggio del rotore utilizzando la chiave a brugola esagonale che vi è stata fornita e girando in senso orario. Controllare che il rotore sia fissato stabilmente.

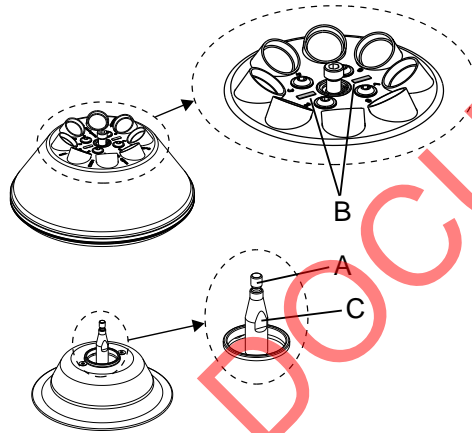

I rotori devono essere caricati esclusivamente in modo simmetrico. I tubi del sangue devono essere distribuiti uniformemente su tutte le posizioni del rotore.

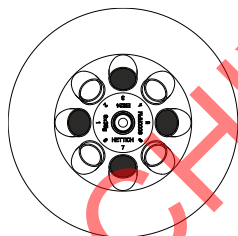

Il rotore è caricato uniformemente

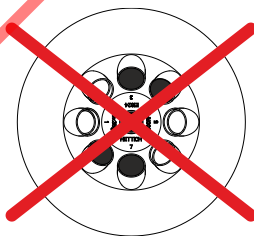

Il rotore è caricato in modo non uniforme

Non ammesso!

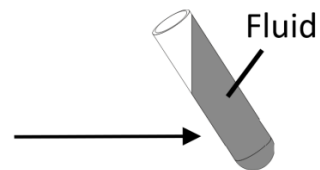

Centrifugal force

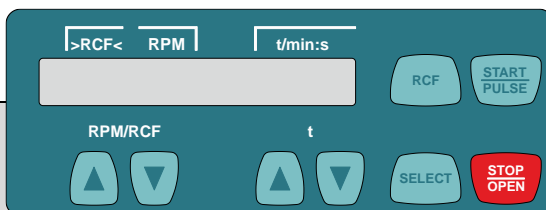

Le provette di sangue possono essere archiviate solo all'esterno della centrifuga. La quantità massima di riempimento per le provette del sangue è specificata sulle provette stesse e non deve superare il peso massimo indicato sul rotore. Il riempimento dei contenitori di centrifugazione è consentito solo fino al livello per cui, durante l'operazione di centrifugazione, non venga espulso alcun liquido dai contenitori. Con il caricamento del rotore non deve pervenire alcun liquido nel rotore e nel vano di centrifugazione. Al fine di mantenere le differenze di peso all'interno del contenitore della centrifuga il più ininfluenza possibile, si raccomanda un livello di riempimento costante nelle provette del sangue.

13.5 DESCRIZIONE DEGLI ELEMENTI DEL DISPLAY



Simbolo / Tasto pannello	Descrizione
	Coperchio sbloccato.
	Coperchio bloccato.
	Indicazione di rotazione. L'indicazione di rotazione si illumina e ruota senso antiorario, quando il rotore gira.
	Immettere direttamente il regime di rotazione. Tenendo premuto il tasto il valore cambia con l'incrementare della velocità.
	Immettere direttamente il tempo di funzionamento. Regolabile fino ad 1 minuto in passi di 1 secondo ed a partire da 1 minuto in passi di 1 minuto. Immettere il parametro di centrifugazione. Tenendo premuto il tasto il valore cambia con l'incrementare della velocità.
	Per attivare singoli parametri. Ad ogni ulteriore pressione del tasto viene selezionato il parametro successivo. Tener premuto il tasto per 8 secondi per chiamare il "MACHINE MENU". Scegliere nel "Machine Menu" i menu "-> Info", "->Settings" e "->Time & Cycles". Sfogliare in avanti nei menu.
	Per alternare la visualizzazione della velocità (RPM) e la relativa visualizzazione della forza centrifuga (>RCF<). I valori RCF sono visualizzati tra le frecce ><.
	Avviare il processo di centrifugazione. • Centrifugazione breve. Il processo di centrifugazione avviene, per il tempo in cui il tasto viene premuto. Per selezionare i menu "->Info", "->Settings" e "->Time & Cycles".
	Terminare il processo di centrifugazione. Il rotore rallenta con il livello di frenata preselezionato. Una doppia pressione del tasto attiva l'Arresto di Emergenza. Sbloccare il coperchio.
t/min	Tempo di funzionamento. Regolabile da 1 - 99 min, in passi di 1 minuto.
t/sec	Tempo di funzionamento. Regolabile da 1 - 59 s, in passi di 1 secondo. Funzionamento continuo "--:--". Impostare il parametro t/min e t/sec su zero.
RPM	Velocità di rotazione. Può essere impostato un valore numerico di 200 RPM fino al regime massimo di rotazione del rotore. Impostabile in passi di 10.
>RCF<	Accelerazione relativa di centrifuga. Può essere impostato un valore numerico, con il quale si ottiene una velocità di rotazione tra 200 RPM ed il massimo regime di rotazione del rotore. Impostabile in passi di 1. L'inoltro della accelerazione relativa di centrifuga (RCF) è possibile solo, se viene scelta l'indicazione RCF (>RCF<). L'accelerazione relativa di centrifuga (RCF) dipende dal raggio di centrifugazione (RAD). Dopo l'inoltro di RCF verificare, che sia impostato l'esatto raggio di centrifugazione.
RAD/mm	Raggio di centrifugazione. Impostabile da 10 mm fino a 250 mm, in passi di 1 millimetro. L'inoltro del raggio di centrifugazione è possibile solo, se viene scelta l'indicazione RCF (>RCF<).
~_DEC	Livello di frenata. fast = arresto in breve tempo, slow = arresto in tempo lungo.

13.6 INOLTRO DIRETTO DEL PARAMETRO DI CENTRIFUGAZIONE

La velocità di rotazione (RPM), l'accelerazione relativa di centrifuga (RCF), il raggio di centrifugazione (RAD) ed il tempo di funzionamento possono venire immessi direttamente con i tasti  , senza dover premere in precedenza il tasto . I parametri di centrifugazione impostati vengono memorizzati solo dopo l'avvio del processo di centrifugazione.

Per la velocità di rotazione (RPM):

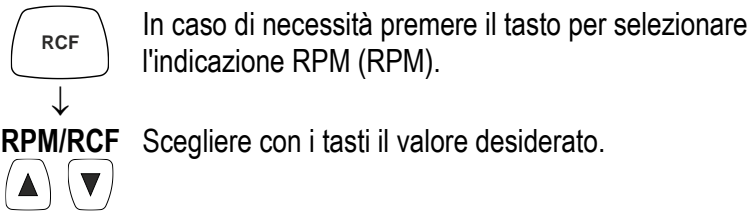

Esempio:

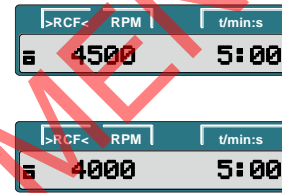

Per l'accelerazione relativa di centrifuga (RCF) e raggio di centrifugazione (RAD):

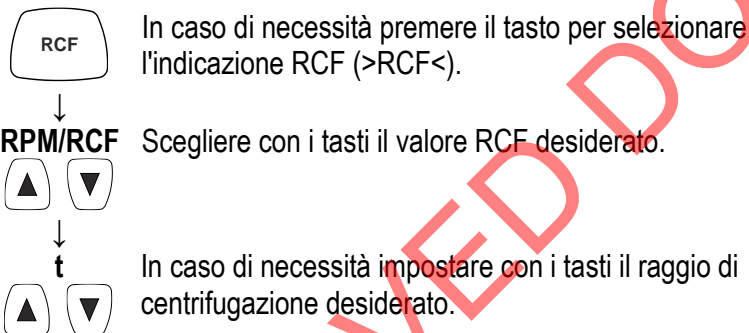

Esempio:

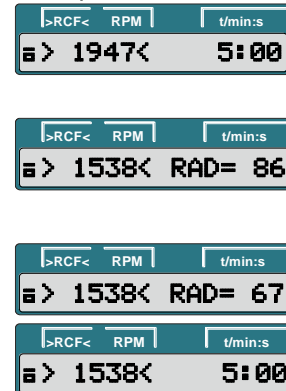

Tempo di funzionamento:

Il tempo di funzionamento può essere impostato fino ad 1 minuto in passi di 1 secondo ed a partire da 1 minuto solo in passi di un minuto. Per impostare il funzionamento continuo, i parametri t/min e t/sec devono essere impostati su zero. Sull'indicatore del tempo (t/min:s) compare "--:--".

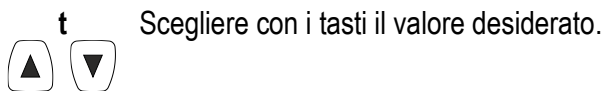

Esempio:

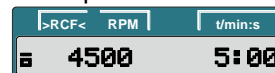



13.7 SELEZIONE DEL PARAMETRO DI CENTRIFUGAZIONE CON IL TASTO "SELECT"

Il tempo di funzionamento può essere impostato in minuti ed in secondi (parametri **t/min** e **t/sec**). Per impostare il funzionamento continuo, i parametri **t/min** e **t/sec** devono essere impostati su zero. Nell'indicatore del tempo (t/min:s) compare "--:--".



Esempio:

L'accelerazione relativa di centrifuga (RCF) dipende dal raggio di centrifugazione (RAD). Durante la selezione dell'RCF viene visualizzato il raggio di centrifugazione impostato. Se dopo la selezione o durante la scelta dei parametri, per otto secondi di tempo non viene premuto alcun tasto, sul display vengono visualizzati di nuovo i valori precedenti. L'impostazione dei parametri deve poi essere eseguito nuovamente.

Premendo il tasto  vengono memorizzate le impostazioni. Con la selezione di più parametri, il tasto  deve essere premuto solo dopo l'impostazione dell'ultimo parametro. L'impostazione dei parametri può sempre essere interrotto premendo il tasto . In questo caso le impostazioni non vengono memorizzate.

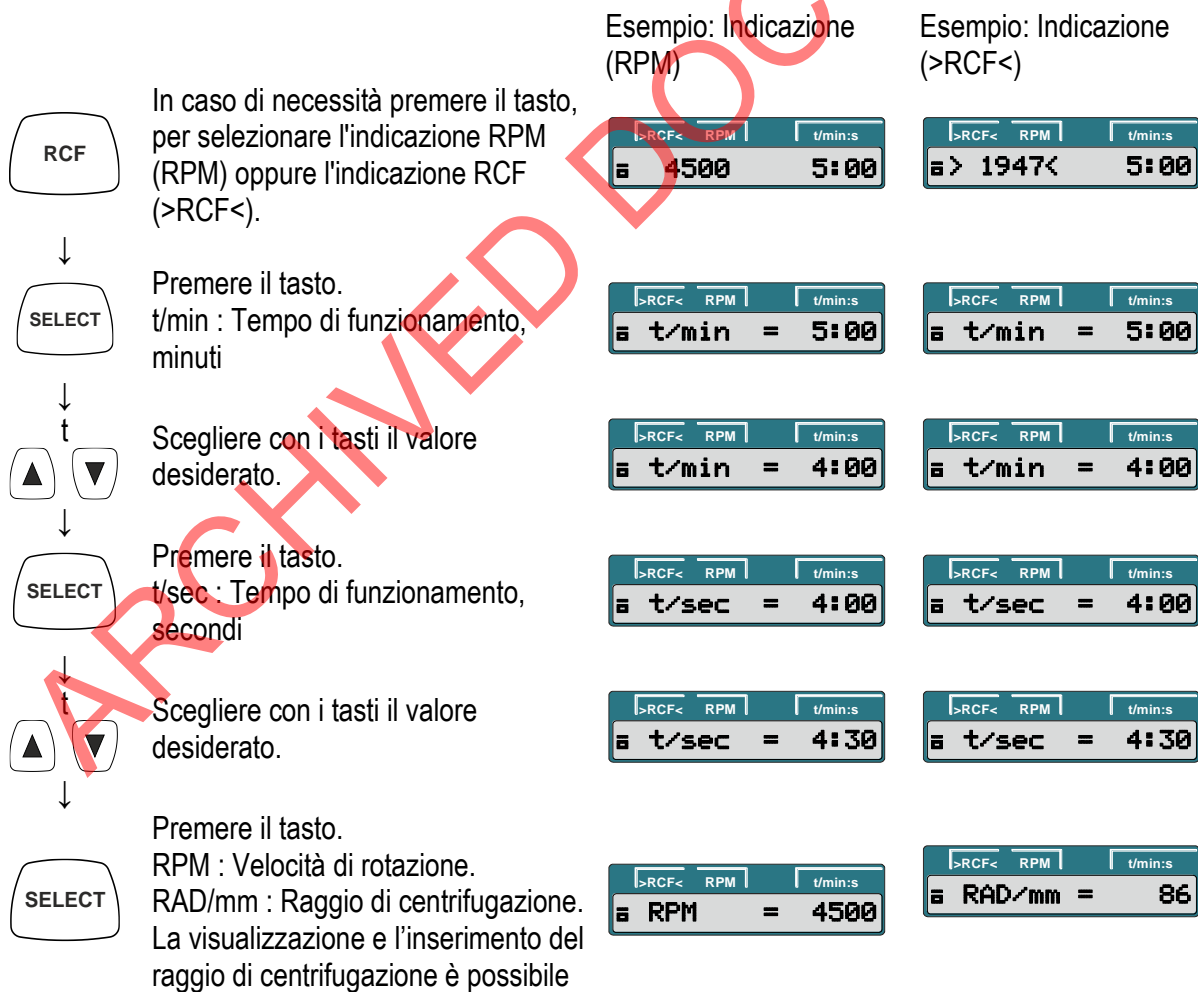

solo se viene scelta l'indicazione RCF (>RCF<).

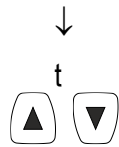

Scegliere con i tasti il valore desiderato.

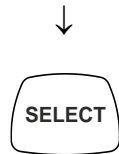

Premere il tasto.
R : Raggio di centrifugazione.
RCF : Accelerazione relativa di centrifuga.

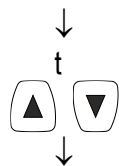

Scegliere con i tasti il valore desiderato.



Premere il tasto.
~_DEC: Livello di frenata.
fast : arresto in breve tempo.
slow : arresto in tempo lungo.

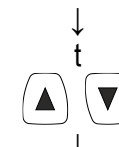

Scegliere con i tasti il valore desiderato.

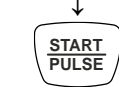
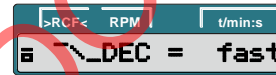

Premere il tasto per memorizzare l'impostazione.

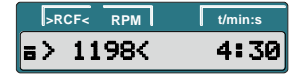

13.8 DISPLAY DEL PANNELLO DI CONTROLLO

Dopo ogni processo di centrifugazione, durante lo sbloccaggio del coperchio, viene visualizzata per breve tempo la quantità dei cicli operativi rimanenti (processi di centrifugazione).

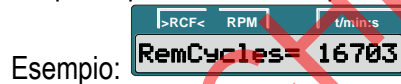

Se con il caricamento del rotore è stata superata la differenza di peso ammessa, il processo di centrifugazione viene interrotto durante l'avvio e verrà visualizzato "IMBALANCE".



Un processo di centrifugazione può sempre venire interrotto premendo il tasto . Durante un processo di centrifugazione i parametri di centrifugazione possono essere selezionati e modificati. I valori modificati sono validi però solo per l'attuale processo di centrifugazione e non vengono memorizzati. Con il tasto può avvenire in qualsiasi momento la commutazione tra l'indicazione RPM (RPM) e l'indicazione RCF (>RCF<). Se il lavoro avviene con l'indicazione RCF (>RCF<) è necessario impostare il raggio di

centrifugazione. Un ulteriore intervento operativo alla centrifuga è possibile solo dopo l'apertura del coperchio. Gli errori operativi e le anomalie vengono visualizzati.

Esempio: 

13.9 CENTRIFUGAZIONE CON PRESELEZIONE DEL TEMPO



Esempio:
Indicazione (RPM)



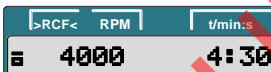





Esempio:
Indicazione (>RCF<)







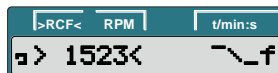

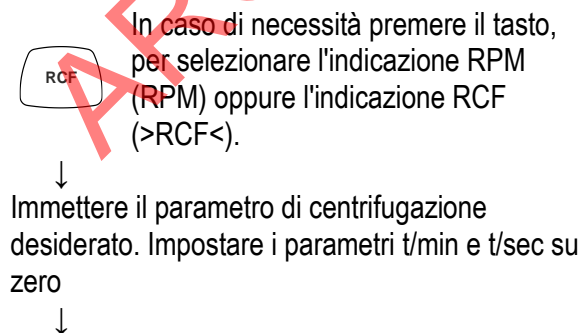

13.10 FUNZIONAMENTO CONTINUO



Esempio:
Indicazione (RPM)





Esempio:
Indicazione (>RCF<)







Premere il tasto, per avviare il processo di centrifugazione. Durante il processo di centrifugazione vengono visualizzati la velocità di rotazione del rotore o il valore RCF che ne risulta e il tempo residuo.

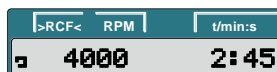

Premere il tasto, per terminare il processo di centrifugazione. L'arresto avviene con il livello di frenata impostato. Viene visualizzato il livello di frenata ~\f

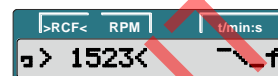
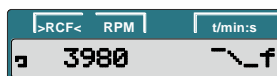

13.11 CENTRIFUGAZIONE BREVE



In caso di necessità premere il tasto, per selezionare l'indicazione RPM (RPM) oppure l'indicazione RCF (>RCF<).

Esempio:
Indicazione (RPM)



Esempio:
Indicazione (>RCF<)

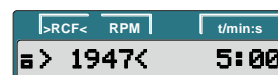

Immettere il parametro di centrifugazione desiderato



Premere il tasto e tenerlo premuto. Durante il processo di centrifugazione vengono visualizzati la velocità di rotazione del rotore o il valore RCF che ne risulta e il tempo decorso.

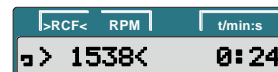
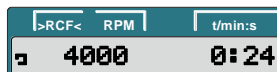
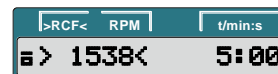

Abbandonare il tasto per terminare il processo di centrifugazione. L'arresto avviene con il livello di frenata impostato. Viene visualizzato il livello di frenata ~\f

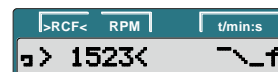
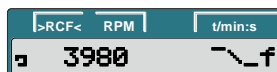

13.12 ARRESTO DI EMERGENZA

Esempio:
Indicazione (RPM)

Esempio:
Indicazione (>RCF<)



Premere due volte il tasto.
 Con l'arresto di emergenza, l'arresto avviene con il livello di frenata "fast" (arresto in breve tempo). Viene visualizzato il livello di frenata ~f



13.13 CONTATORE CICLI

La centrifuga è dotata di un contatore cicli, che conteggia i cicli operativi (processi di centrifugazione). Dopo ogni processo di centrifugazione, durante lo sbloccaggio del coperchio, viene visualizzata per breve tempo la quantità dei cicli operativi rimanenti (processi di centrifugazione).

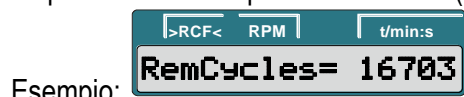

Se la quantità massima ammessa dei cicli operativi del rotore è oltrepassata, dopo ogni avvio di un processo di centrifugazione compare la seguente videata ed il processo di centrifugazione deve essere avviato di nuovo. Per ragioni di sicurezza il rotore deve essere sostituito immediatamente con un rotore nuovo. Dopo che il rotore è stato sostituito, il contatore cicli deve essere reimpostato su "0".



13.14 REIMPOSTARE SU ZERO IL CONTATORE CICLI

Dopo che il rotore è stato sostituito, il contatore cicli deve essere reimpostato su zero. Il resettaggio su zero del contatore cicli è ammesso solo, se il rotore è stato sostituito in precedenza con un rotore nuovo. Il resettaggio del contatore cicli può essere eseguito, durante l'arresto del rotore, come segue. Il processo può sempre essere interrotto premendo il tasto . In questo caso le impostazioni non vengono memorizzate.



Tenere premuto il tasto 8 secondi.



Premere il tasto più volte fino a quando compare la seguente videata.



Premere il tasto.

Esempio:



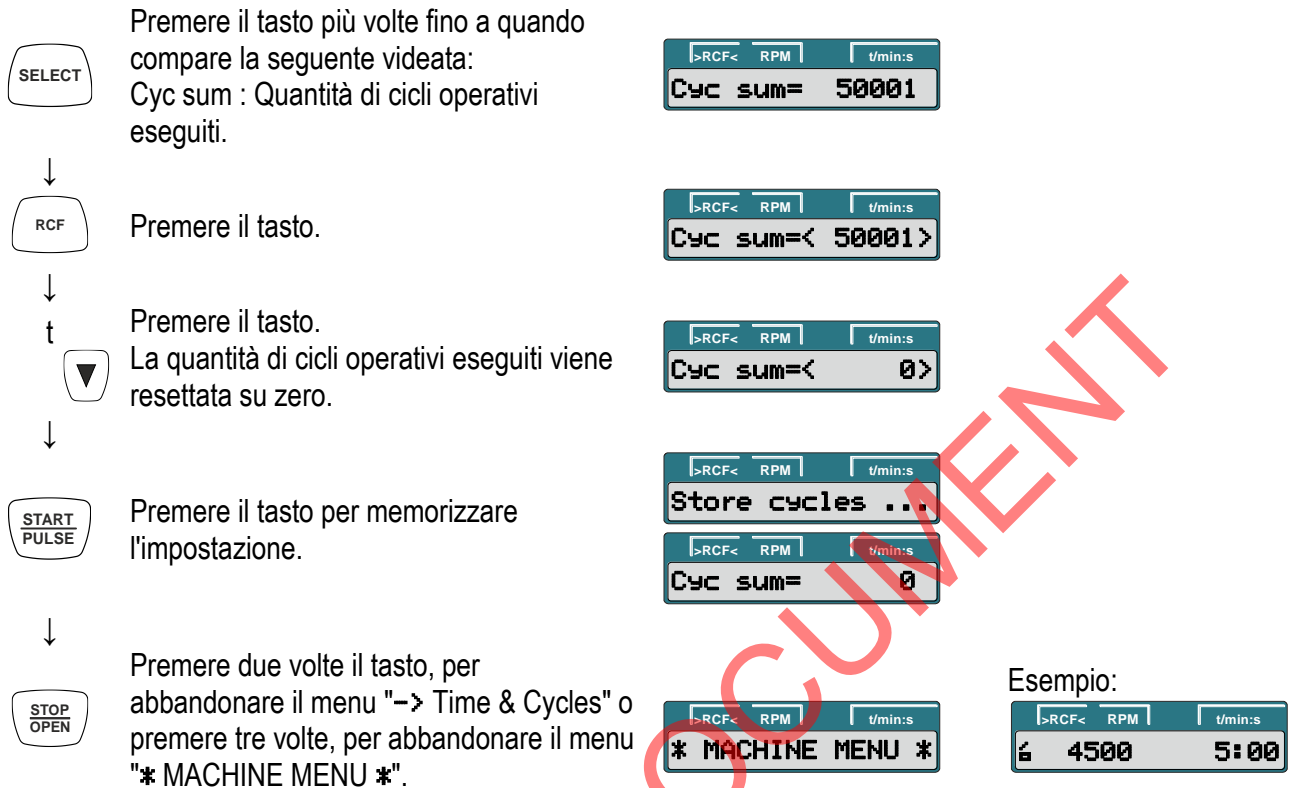

13.15 IMPOSTAZIONI E CONSULTAZIONI

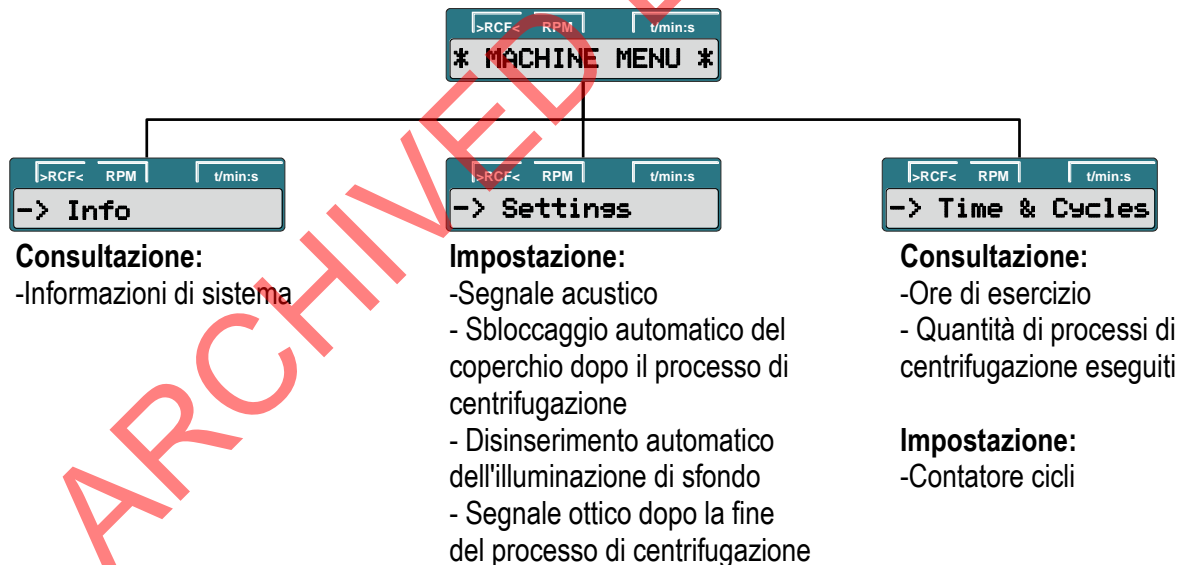

13.16 CONSULTARE LE INFORMAZIONI DI SISTEMA

Possono venir consultate le seguenti informazioni di sistema:

- Modello dell'apparecchiatura,
- Versione del programma dell'apparecchiatura,
- Numero del tipo di apparecchiatura,

- Data di produzione dell'apparecchiatura,
- Numero di serie dell'apparecchiatura,
- Tipo di convertitore di frequenza,
- Versione di programma del convertitore di frequenza

La consultazione può essere eseguita, durante l'arresto del rotore, come segue: Il processo può sempre essere interrotto premendo il tasto .

 Tenere premuto il tasto 8 secondi.



↓
 Premere il tasto.



↓
 Premere il tasto.
Modello dell'apparecchiatura



↓
 Premere il tasto.
Versione del programma dell'apparecchiatura.



↓
 Premere il tasto.
Type#1 : Numero del tipo di apparecchiatura



↓
 Premere il tasto.
Type#2 : Prosecuzione del numero del tipo, se questi ha più posizioni del campo di videata "Type#1".



↓
 Premere il tasto.
Data di produzione dell'apparecchiatura.

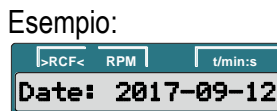

↓
 Premere il tasto.
Numero di serie dell'apparecchiatura.



↓
 Premere il tasto.
Tipo di convertitore di frequenza.

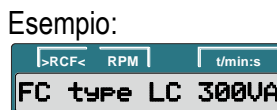



Premere il tasto.
Versione di programma del convertitore di frequenza.

Esempio:

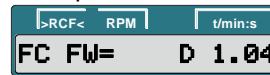

Premere due volte il tasto, per abbandonare il menu "-> Info" o premere tre volte, per abbandonare il menu "* MACHINE MENU *".



Esempio:



13.17 SEGNALE ACUSTICO

Il segnale acustico suona: (1) dopo che si è presentata un'anomalia, in intervalli di 2 s. (2) dopo che è terminato il processo di centrifugazione e con l'arresto del rotore, in intervalli di 30 s. Il segnale acustico viene disinserito premendo un tasto piacere. Il segnale acustico può essere impostato, durante l'arresto del rotore, come segue. Il processo può sempre essere interrotto premendo il tasto . In questo caso le impostazioni non vengono memorizzate.



Tenere premuto il tasto 8 secondi.



Premere il tasto più volte fino a quando compare la seguente videata.

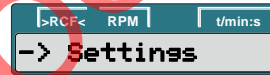

Premere il tasto.



End beep : Segnale acustico dopo che il processo di centrifugazione è terminato.
off : Segnale disattivato.
on : Segnale attivato.

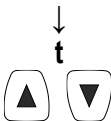

Con i tasti impostare **off** (disinserito) oppure **on** (inserito).



Premere il tasto.



Error beep : Segnale acustico dopo che si è presentata un'anomalia.
off : Segnale disattivato.
on : Segnale attivato.

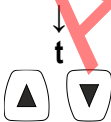

Con i tasti impostare **off** (disinserito) oppure **on** (inserito).





Premere il tasto.
Beep volume : Intensità del segnale acustico.
min : lieve
mid : media
max : forte

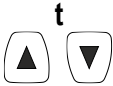

Con i tasti impostare **min**, **mid**, oppure **max**.



Premere il tasto per memorizzare l'impostazione.



Premere una volta il tasto, per abbandonare il menu "-> Settings" oppure prendere due volte, per abbandonare il menu "* MACHINE MENU *".



Esempio:



13.18 SEGNALE VISIVO DOPO LA FINE DEL PROCESSO DI CENTRIFUGAZIONE

L' illuminazione di sfondo della videata lampeggia dopo il processo di centrifugazione, per segnalare visivamente che il processo di centrifugazione è terminato. Il segnale visivo può essere inserito o disinserito, durante l'arresto del rotore, come segue. Il processo può sempre essere interrotto premendo il tasto .



Tenere premuto il tasto 8 secondi.



Premere il tasto più volte fino a quando compare la successiva videata.



Premere il tasto.



Premere più volte il tasto fino a quando compare una delle due videate.
End blinking : Lampeggio dell' illuminazione di sfondo della videata dopo il processo di centrifugazione.
off : L' illuminazione di sfondo non lampeggia.
on : L' illuminazione di sfondo lampeggia.



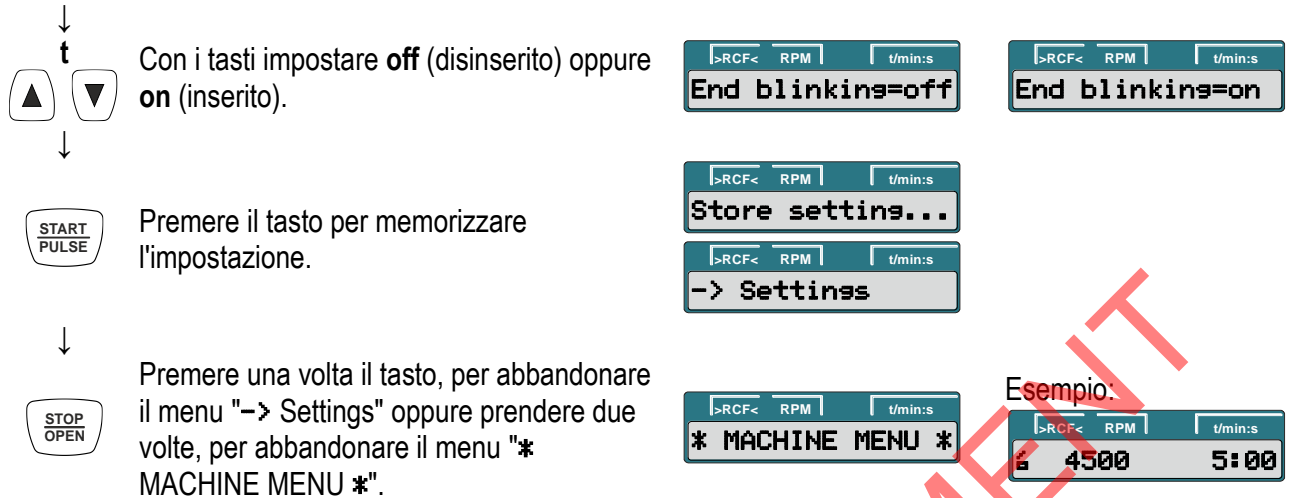

13.19 SBLOCCAGGIO AUTOMATICO DEL COPERCHIO DOPO IL PROCESSO DI CENTRIFUGAZIONE

Può essere impostato, se dopo il processo di centrifugazione il coperchio si sblocca o meno. Ciò può essere impostato durante l'arresto del rotore, come segue. Il processo può sempre essere interrotto premendo il tasto . In questo caso le impostazioni non vengono memorizzate.

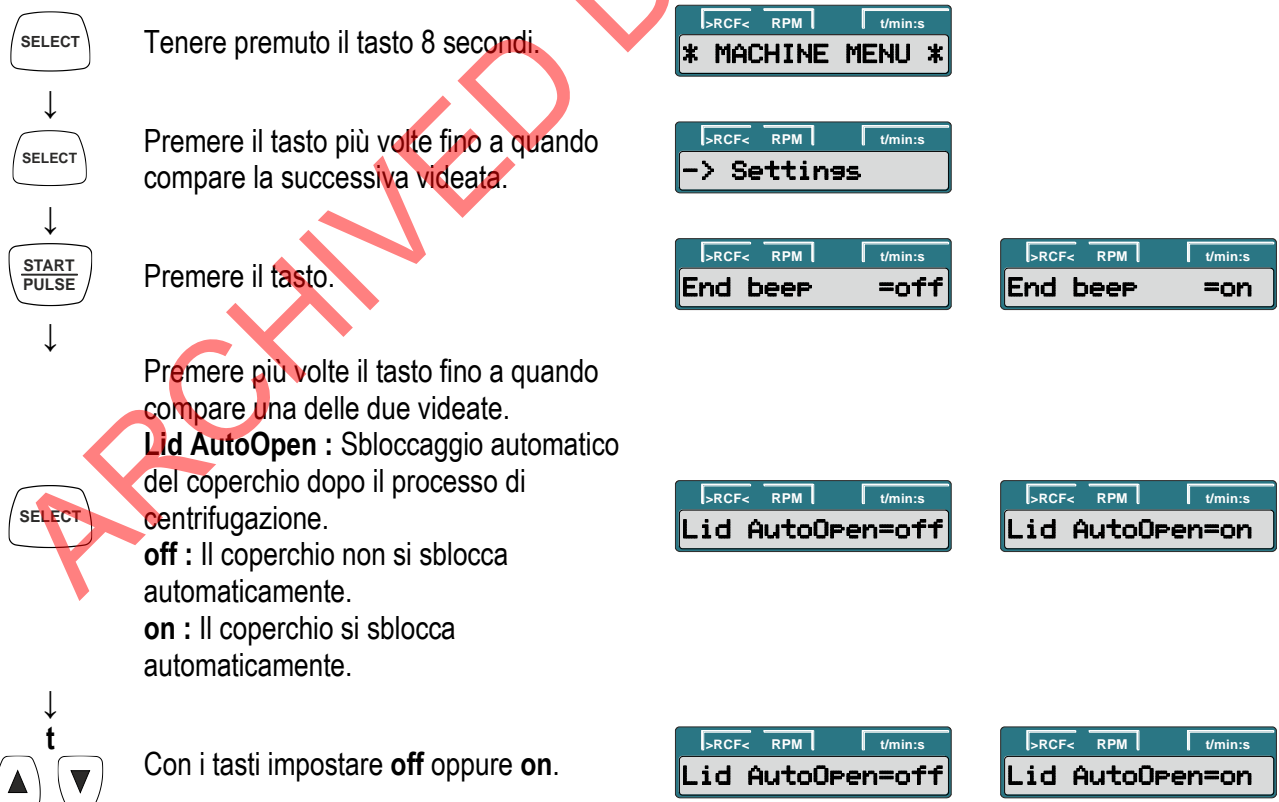



Premere il tasto per memorizzare l'impostazione.



Premere una volta il tasto, per abbandonare il menu "-> Settings" oppure prendere due volte, per abbandonare il menu "* MACHINE MENU *".



Esempio:



13.20 ILLUMINAZIONE DI SFONDO DELLA VIDEATA

Per risparmiare energia può essere impostato che dopo un processo di centrifugazione l'illuminazione di sfondo della videata si spenga dopo due minuti. Ciò può essere impostato durante l'arresto del rotore, come segue. Il processo può sempre essere interrotto premendo il tasto . In questo caso le impostazioni non vengono memorizzate.



Tenere premuto il tasto 8 secondi.

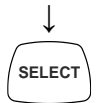

Premere il tasto più volte fino a quando compare la seguente videata.

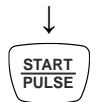

Premere il tasto.

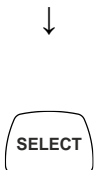

Premere più volte il tasto fino a quando compare una delle due videate.:

Power save: Disinserimento automatico dell'illuminazione di sfondo.

off: Disinserimento automatico disattivato.

on: Disinserimento automatico attivato.

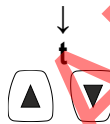

Con i tasti impostare **off** (disinserito) oppure **on** (inserito).



Premere il tasto per memorizzare l'impostazione.

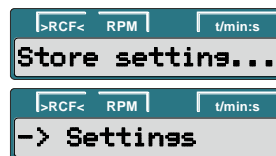



Premere una volta il tasto, per abbandonare il menu "-> Settings" oppure prendere due volte, per abbandonare il menu "* MACHINE MENU *".



Esempio:



13.21 CONSULTAZIONE DELLE ORE DI FUNZIONAMENTO E DELLA QUANTITÀ DI PROCESSI DI CENTRIFUGAZIONE

Le ore di funzionamento sono suddivise in ore di funzionamento interne ed esterne. Ore di funzionamento interne: Tempo complessivo nel quale l'apparecchiatura era inserita. Ore di funzionamento esterne: Tempo complessivo dei processi di centrifugazione avvenuti fino ad ora. La consultazione può essere eseguita,

durante l'arresto del rotore, come segue. Il processo può sempre essere interrotto premendo il tasto



Tenere premuto il tasto 8 secondi.



Premere il tasto più volte fino a quando compare la successiva videata.



Premere il tasto.
TimeExt: Ore di funzionamento esterne.

Esempio:



Premere il tasto.
TimeInt: Ore di funzionamento interne.

Esempio:



Premere il tasto.
Starts: Quantità di tutti i processi di centrifugazione.

Esempio:



Premere due volte il tasto, per abbandonare il menu "-> Time & Cycles" o premere tre volte, per abbandonare il menu "* MACHINE MENU *".



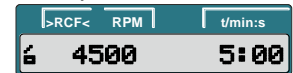

Esempio:



14 GUASTI

Se il guasto non può essere eliminato con l'aiuto della tabella dei guasti riportata di seguito, contattare l'assistenza clienti e specificare il tipo di centrifuga e il numero di serie. Entrambi i numeri sono visibili sulla targhetta di modello della centrifuga.

Esecuzione di un RESET RETE: Spegner l'interruttore di rete (posizione interruttore "0"). Attendere almeno 10 secondi quindi riaccendere l'interruttore di rete (posizione interruttore "I").

Visualizzazione/guasto		Causa	Eliminazione
Nessun indicatore		Assenza di tensione Scatto del fusibile di sicurezza per sovracorrente.	<ul style="list-style-type: none"> – Controllare la tensione di alimentazione. – Controllare il fusibile di ingresso dell'alimentazione di rete e consultare le istruzioni per la sostituzione del fusibile di rete. – Interruttore generale ACCESO.
IMBALANCE		Il rotore è caricato in modo non uniforme.	<ul style="list-style-type: none"> – Aprire il coperchio dopo che il rotore si è fermato. – Controllare il caricamento del rotore. – Ripetere il ciclo di centrifugazione.
MAINS INTER	11	Interruzione di rete durante il ciclo di centrifugazione. (Il ciclo di centrifugazione non viene terminato.)	<ul style="list-style-type: none"> – Aprire il coperchio dopo che il rotore si è fermato. – Premere tasto start/pause. – All'occorrenza ripetere il ciclo di centrifugazione.
MAINS INTERRUPT			
TACHO ERROR	1, 2	Mancanza degli impulsi del numero di giri durante il funzionamento.	<ul style="list-style-type: none"> – Dopo l'arresto del rotore eseguire un RESET RETE.
LID ERROR	4.1 – 4.127	Errore blocco coperchio, ovvero chiusura coperchio	
OVER SPEED	5	N° giri eccedente	
VERSION ERROR	12	Riconosciuto un modello di centrifuga sbagliato. Guasto/difetto sistema elettronico	<ul style="list-style-type: none"> – Dopo l'arresto del rotore eseguire un RESET RETE.
UNDER SPEED	13	N° giri insufficiente	
CTRL ERROR	22.1, 25.2	Guasto/difetto sistema elettronico.	
CRC ERROR	27.1		
COM ERROR	31 – 36		
FC ERROR	60, 61.1 – 61.21, 61.64 – 61.142		
FC ERROR	61.23	Errore misurazione velocità di rotazione	<ul style="list-style-type: none"> – Il disinserimento dell'apparecchiatura non è ammesso, fino a quando l'indicazione della rotazione  è luminosa e ruota. Attendere fino a quando il simbolo  (coperchio bloccato) viene visualizzato (dopo ca. 120 secondi). Eseguire poi un RESET RETE.
TACHO ERR	61.22		
FC ERROR	61.153	Guasto/difetto sistema elettronico.	<ul style="list-style-type: none"> – Esecuzione di un RESET RETE. – Controllare il caricamento del rotore secondo le istruzioni fornite. – Ripetere il ciclo di centrifugazione.

15 ACCELERAZIONE CENTRIFUGA RELATIVA (RCF)

L'accelerazione centrifuga relativa (RCF) è indicata come un multiplo dell'accelerazione terrestre (g). È un valore numerico privo di unità e funge per paragonare le prestazioni di separazione e sedimentazione. L'accelerazione centrifuga relativa (RCF) dipende dal numero dei giri e dal raggio di centrifugazione. Può essere calcolato utilizzando la formula seguente:

$$RCF = \left(\frac{RPM}{1000} \right)^2 \times r \times 1,118 \Rightarrow RPM = \sqrt{\frac{RCF}{r \times 1,118}} \times 1000$$

RCF = accelerazione centrifuga relativa

RPM = numero dei giri

r = raggio di centrifugazione in mm = distanza dal centro dell'asse di rotazione fino al fondo del recipiente di centrifugazione.

16 TRASPORTO ED STOCCAGGIO

Prima di effettuare il trasporto dell'apparecchiatura deve essere installato il dispositivo di sicurezza per il trasporto. Lo stoccaggio dell'apparecchiatura e degli accessori è ammesso solo in ambienti chiusi ed asciutti. Quando il dispositivo e gli accessori vengono trasportati o conservati, devono essere rispettate le seguenti condizioni:

Temperatura ambiente: -20 °C fino a +60 °C.

Umidità relativa dell'aria: 10% fino a 80%, non condensante.

17 SOSTITUZIONE FUSIBILI ENTRATA RETE

Inizia spegnendo l'interruttore di rete e staccando il dispositivo dalla rete. Il portafusibili (A) con i fusibili d'entrata rete si trova accanto all'interruttore di rete. Estrarre il cavo di collegamento dalla spina. Premere la chiusura a scatto (B) contro il portafusibili (A) ed estrarre quest'ultimo. Sostituire i fusibili di rete difettosi. Utilizzare solo i fusibili con il valore nominale definito per il tipo di centrifuga fornito dal produttore. Inserire di nuovo il portafusibili fino a far scattare la chiusura. Allacciare di nuovo l'apparecchio alla rete.

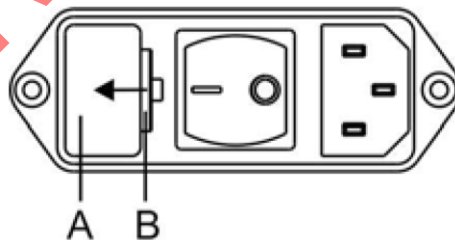

18 RISPEDIZIONE DI APPARECCHI

Prima di rispeditore un apparecchio deve essere montata la protezione per il trasporto. Se il dispositivo o i suoi accessori vengono restituiti al produttore legale, al fine di proteggere le persone, l'ambiente e i materiali, devono essere decontaminati e puliti prima di essere spediti. Il produttore legale si riserva il diritto di rifiutare dispositivi o accessori contaminati. Eventuali costi di pulizia e disinfezione verranno fatturati al cliente..

19 SMALTIMENTO

Prima dello smaltimento, l'apparecchiatura deve essere decontaminata e pulita con lo scopo di proteggere le persone, l'ambiente e il materiale. Per lo smaltimento dell'apparecchio osservare le rispettive norme di legge. Ai sensi della direttiva 2002/96/CE (RAEE) tutti gli apparecchi forniti dopo il 13/08/2005 non possono più essere smaltiti con i rifiuti domestici. Questo apparecchio appartiene alla categoria 8 (Dispositivi medicali) ed è classificato nel settore Business-to-Business. Il simbolo della pattumiera cancellata con una croce indica che l'apparecchio non deve essere smaltito con i rifiuti domestici. Le norme per lo smaltimento possono essere differenti nei singoli paesi. In caso di necessità rivolgersi al proprio rivenditore.

ARCHIVED DOCUMENT



A tabela de símbolos abaixo é apenas para referência. Consulte a etiqueta de embalagem do produto para os símbolos aplicáveis.

Símbolo	Símbolo Descrição
	Cuidado
	Instruções de utilização eletrónicas
	Fabricante
	BioHorizons products apresenta a marca CE e cumpre os requisitos da diretiva de dispositivos médicos 93/42/CEE
	Número de referência/artigo
	Número de lote
	Não reutilizar
	Não reesterilize.
	Prazo de validade
	Esterilizado por radiação gama
	Data de fabrico
	Cuidado: a legislação federal dos EUA restringe a venda, distribuição e utilização destes dispositivos por, ou por indicação de um dentista ou médico

Símbolo	Símbolo Descrição
	Posição inicial
	Não utilizar se a embalagem estiver danificada
	Dispositivo médico
	Não esterilizado
	Manter seco
	Frágil; manuseie com cuidado
	Limites de temperatura
	Este lado para cima
	Limites de humidade
	Aviso; Perigo biológico
	Anotações importantes
	Coleta separada de dispositivos elétricos e eletrónicos.
	Representante Autorizado da UE

1 INDICAÇÕES DE USO

O Sistema IntraSpin destina-se a ser utilizado para a preparação rápida e segura de fibrina rica em plaquetas (L-PRF) autóloga a partir de uma pequena amostra de sangue no ponto de atendimento do paciente. A L-PRF é misturada com osso de autoenxerto e/ou aloenxerto antes da aplicação num defeito ósseo para melhorar as características de manuseamento.

2 CONTRA-INDICAÇÕES

A centrífuga IntraSpin destina-se apenas aos fins indicados no uso pretendido do dispositivo. Qualquer outro uso do dispositivo é considerado não pretendido. O uso da centrífuga IntraSpin é contra-indicado na presença de uma ou mais das seguintes situações clínicas: Pacientes com dependência de álcool ou distúrbios psiquiátricos, discrasias sanguíneas, diabetes não controlado, hipertireoidismo, infecções orais, malignidades ou pacientes que tiveram enfarte do miocárdio nos últimos 12 meses. Pacientes com doenças sistêmicas que comprometem o sistema imunológico, como HIV, pacientes em uso de medicamentos que comprometam a cicatrização de um local de implante, pacientes com histórico de má ou não adesão aos procedimentos de higiene bucal.

Pacientes que participam de terapia anticoagulante. Esses pacientes não são excluídos dos benefícios da PRF; em vez disso, o ponto de atendimento deve adicionar um tempo adicional à centrífuga para que a separação seja eficaz para uso.



3 NOTAS SOBRE A SEGURANÇA

- Nenhuma reclamação de garantia será considerada pelo fabricante, a não ser que TODAS as instruções contidas neste manual tenham sido seguidas.
- As instruções de operação fazem parte do dispositivo. Elas devem sempre ser mantidas prontamente disponíveis. Se o dispositivo estiver configurado em um local diferente, as instruções de operação devem ser fornecidas com ele.
- A centrífuga deve ser instalada numa boa base estável.
- Antes de utilizar a centrífuga, verifique bem o rotor em relação à sua firme instalação.
- Quando a centrífuga estiver a funcionar, de acordo com a norma EN / IEC 61010-2-020, nenhuma pessoa, substâncias perigosas ou objetos podem estar dentro da margem de segurança de 300 mm em redor da centrífuga.
- Os rotores, as suspensões e os acessórios que possuam vestígios de corrosão ou danos mecânicos ou cujo prazo de utilização tenha expirado, não podem continuar a ser utilizados.
- A centrífuga não pode mais ser colocada em funcionamento quando a câmara de centrifugação tiver danos relacionados com a segurança.
- Para centrífugas sem controlo de temperatura, quando a temperatura ambiente é aumentada e/ou se o dispositivo é utilizado frequentemente, a câmara de centrifugação pode ser aquecida. Portanto, não se pode excluir que o material da amostra possa ter mudado devido à temperatura.
- Antes da operação inicial da sua centrífuga, deve ler e prestar atenção às instruções de utilização. Apenas o pessoal que leu e compreendeu as instruções de utilização tem permissão para utilizar o dispositivo.
- Juntamente com as instruções de utilização e os regulamentos legais sobre a prevenção de acidentes, deve-se também seguir os regulamentos profissionais reconhecidos para trabalhar de forma segura e profissional. Estas instruções de utilização devem ser lidas em conjunto com

quaisquer outras instruções relativas à prevenção de acidentes e à proteção do ambiente com base nos regulamentos nacionais do país onde o dispositivo vai ser utilizado.

- É da responsabilidade do utilizador, o cumprimento dos requisitos específicos do país em matéria de segurança ocupacional, no que diz respeito à utilização de centrífugas nos locais de trabalho previstos para esta finalidade pelo utilizador.
- Esta centrífuga é uma peça de equipamento da última geração que é extremamente segura para operar. No entanto, pode originar perigo para os utilizadores ou outros se for utilizada por pessoal não formado, de maneira inadequada ou para uma finalidade diferente daquela para que foi projetada.
- A centrífuga não deve ser movida nem sofrer qualquer choque durante a operação.
- Em caso de falha ou libertação de emergência, nunca toque no rotor antes dele parar de rodar.
- Para evitar danos devidos à condensação, ao mudar de um compartimento frio para um quente, a centrífuga deve aquecer durante, pelo menos, 3 horas no compartimento quente antes de ser ligada à rede, ou funcionar quente durante 30 minutos no compartimento frio.
- Quando se centrifuga com rotações máximas por minuto, a densidade dos materiais ou das misturas dos materiais não pode exceder 1,2 kg/dm³.
- A centrífuga pode ser utilizada apenas quando o equilíbrio está dentro dos limites de aceitabilidade.
- A centrífuga não pode ser utilizada em áreas com perigo de explosão.
- A centrífuga não deve ser utilizada com: materiais inflamáveis ou explosivos; materiais que reajam uns com os outros produzindo muita energia.
- Nenhum sistema de biossegurança está disponível para esta centrífuga.
- A centrífuga não deve ser utilizada com substâncias altamente corrosivas que podem prejudicar a integridade mecânica dos rotores, dos ganchos e dos acessórios.
- As reparações só devem ser efetuadas por pessoal autorizado pelo fabricante.
- Para oferecer aos pacientes o mais alto nível de segurança clínica, os produtos Intra-Lock são fabricados com materiais que são biocompatíveis com plasma humano.
- Este produto não está autorizado para venda em todos os mercados e pode não estar disponível no seu mercado. Consulte o seu representante local da Intra-Lock para obter informações adicionais.

4 COMPONENTES DO SISTEMA INTRASPIN

COMPONENTE	QUANTIDADE POR SISTEMA
Centrífuga IntraSpin incluindo:	1
Cabo de energia	1
Fusível	2
Chave de mão sextavada	1
Tubos de colheita de sangue e tubos de equilíbrio Greiner (utilização única).	150
Conjunto de coleta de sangue de segurança Greiner + suporte, 21G (uso único)	24
Torniquete sem látex	1
Suporte de tubos de ensaio	1
Tesouras cirúrgicas curvas	1
Pinça de tecido cirúrgico	1

Bacia redonda de aço inoxidável	1
Bacia retangular de aço inoxidável	1
Espátula portadora de biomaterial duplo	1
Embalador de biomaterial duplo	1
Caixa Xpression®	1

Apenas componentes compatíveis verificados para uso direto com a centrífuga IntraSpin são recomendados e garantidos:

PARTE COMPATÍVEL #	DESCRIÇÃO
455092	Ativador de coágulo sérico de tubo de 9 ml CAT, tampa vermelha
455001	Tampa branca 9ml Z tubo Sem aditivo
BHEXZ (E613)	Chave IntraSpin, 110v e 220v
BROTORZ (E3694)	Rotor IntraSpin, 100v e 220v
BPOWER110Z (E1673)	Cabo de alimentação IntraSpin, 110v
BPOWER220Z (E1669)	Cabo de alimentação IntraSpin, 220v
BTUBEHOLDZ (E872 x 1)	Substituição do suporte do tubo IntraSpin
BFUSE110Z (E997)	Fusível IntraSpin 110v
BFUSE220Z (E891)	Fusível IntraSpin 220v

5 CONFIGURAÇÃO BREVE DA CENTRIFUGAÇÃO

Remova e guarde os parafusos de transporte da parte inferior da centrífuga. Conecte o cabo CA e conecte-o à tomada elétrica.

Ligue a centrífuga usando a chave oscilante na parte traseira do dispositivo.

Selecione velocidade e tempo: Velocidade = 2700 & Tempo = 12:00 min.

Pressione START (INICIAR).

tampa da centrífuga abrir-se-á automaticamente no final de cada ciclo.

Após o primeiro procedimento, o tempo e a velocidade são registados na memória da centrífuga, a menos que as definições sejam alteradas.

6 PRECAUÇÕES E INSTRUÇÕES PARA OS TUBOS DE COLHEITA DE SANGUE E CONJUNTO DE COLHEITA DE SANGUE

- Não utilize tubos se estiver presente matéria estranha.
- Deve deixar os tubos de colheita de sangue encher completamente.
- Manuseie todas as amostras biológicas e objetos pontiagudos de colheita de sangue (por ex., agulhas e conjuntos de colheita de sangue) de acordo com as políticas e procedimentos da sua instituição.
- Não dobre a agulha.
- Não liberte nem reative o mecanismo de segurança da agulha com força depois de este ter sido ativado.
- Obter atenção médica apropriada no caso de qualquer exposição a amostras biológicas (por exemplo, por lesão por punção) devido à possível transmissão de HIV (AIDS), hepatite viral ou outras doenças infecciosas.

- Descarte todos os objetos cortantes de coleta de sangue em recipientes aprovados para risco biológico.
- A transferência de uma amostra de uma seringa para um tubo não é um procedimento recomendado.
- Se o sangue for coletado através de uma linha intravenosa (IV), siga as políticas e procedimentos da sua instituição para garantir que a linha tenha sido removida da solução IV antes de começar a encher os tubos de coleta de sangue.
- O acelerador de coagulação do sangue pode parecer branco na superfície do tubo, o que não afeta o desempenho dos tubos. Se qualquer outra descoloração ou precipitado estiver presente no tubo, ele não deve ser usado.
- Não use os tubos após o prazo de validade.
- Armazene os tubos de colheita de sangue a 4–25 °C (40–77 °F).
- Armazene o conjunto de colheita de sangue (agulha e suporte) a 4–36 °C (40–97 °F).
- Evite a exposição à luz solar direta. Exceder a temperatura máxima de armazenamento recomendada pode levar a uma diminuição da qualidade do tubo (ou seja, perda de vácuo, coloração etc.).
- Para evitar refluxo, coloque o braço do paciente em uma posição descendente, segure o tubo com a tampa para cima, solte o torniquete assim que o sangue começar a fluir para dentro do tubo, evite que o conteúdo do tubo entre em contacto com a tampa ou a extremidade da agulha durante o procedimento da punção venosa.
- Antes de realizar a punção venosa, verifique se os materiais a seguir estão facilmente acessíveis: todos os tubos de coleta de sangue necessários, etiquetas identificadas para identificação positiva das amostras pelo paciente, agulhas e suportes para coleta de sangue, compressas com álcool para limpar o local da punção, gaze limpa, torniquete, gesso adesivo ou curativo, recipiente aprovado para risco biológico. Para proteção contra a exposição a agentes patógenos transmitidos pelo sangue, recomenda-se EPI (equipamento de proteção individual) apropriado (por exemplo, luvas, jaleco, óculos de proteção etc.).

Técnica de punção venosa e colheita de amostras de sangue:

A coleta de sangue deve ser feita o mais rápido possível, pois não há anticoagulante nos tubos de coleta. A amostra de sangue começará a coagular imediatamente. Use luvas durante a punção venosa e ao manusear tubos de coleta de sangue para minimizar o risco de exposição. Antes da coleta de sangue, limpe a parte superior da (s) tampa (s) do tubo de sangue com um pano desinfetante de sua escolha. Remova a tampa sobre a seção da válvula da agulha. Prepare o local da punção venosa com um anti-séptico apropriado. Não palpe a área da punção venosa após a limpeza. Coloque o braço do paciente em uma posição descendente. Retire a proteção da agulha. Realize a punção venosa com o braço para baixo e a tampa do tubo na parte superior. Imobilize a agulha com fita, se necessário. Empurre o tubo de coleta de sangue no suporte e na válvula da agulha, perfurando o diafragma de borracha do tubo de coleta de sangue. Centralize os tubos de coleta de sangue no suporte ao penetrar na tampa para evitar a penetração da parede lateral e subsequente perda prematura de vácuo. Remova o torniquete assim que o sangue aparecer no tubo de coleta de sangue. Durante o procedimento, mantenha sempre o tubo de coleta pressionado com o polegar. Isso garantirá um vácuo completo. O tubo de coleta de sangue encherá automaticamente. Se nenhum sangue fluir para o tubo

de coleta ou se o fluxo sanguíneo parar antes que uma amostra adequada seja coletada, as etapas a seguir são sugeridas para concluir uma coleta satisfatória:

- Empurre o tubo de coleta de sangue para frente para garantir a penetração da tampa.
- Confirme a posição correta da agulha na veia.
- Se o sangue ainda não fluir, remova e descarte adequadamente o tubo de coleta. Obtenha um novo tubo de coleta e empurre para dentro do suporte.
- Se o segundo tubo de coleta não puxar, remova e descarte adequadamente a agulha e o tubo de coleta. Repita o procedimento.
- Quando a linha de enchimento de volume máximo da base do tubo de coleta de sangue for atingida, remova-a cuidadosamente do suporte. Repita com um segundo tubo de coleta de sangue.

Inverta suavemente cada tubo de coleta imediatamente após a remoção do suporte. Não agite os tubos cheios de amostra de sangue. A mistura vigorosa pode causar espuma ou hemólise. Misturas insuficientes ou atrasadas nos tubos séricos podem resultar em coagulação retardada.

Após a conclusão da colheita de amostras de sangue, retire a agulha da veia. Ative o mecanismo de segurança (proteção de segurança) da agulha pressionando ambos os lados do conector para engatar o bloqueio. Deslize o mecanismo de segurança para trás até ouvir um clique. Não volte a colocar a tampa na agulha, uma vez que tal aumenta o risco de lesões por picada da agulha e exposição ao sangue. Elimine a agulha usada com o suporte utilizando um recipiente de eliminação de risco biológico adequado. Aplique pressão no local da punção com um cotonete seco e estéril até que o sangramento pare. Se desejar, aplique um curativo assim que ocorrer a coagulação. Recomenda-se que os tubos de coleta cheios sejam mantidos na posição vertical. Quando o segundo tubo estiver cheio, remova-o e coloque o primeiro e o segundo tubos na centrífuga em locais opostos para contrabalançar o rotor, feche a tampa da centrífuga IntraSpin® e pressione o botão “START” (INICIAR) para permitir que rode durante 12 MINUTOS.

Se for necessário mais do que dois tubos de sangue, siga este procedimento alternativo: após a colheita dos dois primeiros tubos de sangue e depois de os inverter cuidadosamente, coloque-os imediatamente na centrífuga IntraSpin, em lados opostos para garantir que a centrífuga está devidamente equilibrada. Feche a tampa e pressione o botão INICIAR e deixe a centrífuga funcionar enquanto você coleta os tubos restantes de sangue. Pressione o botão STOP e deixe a centrífuga parar completamente. A tampa será aberta; coloque imediatamente os tubos restantes na centrífuga opostos um ao outro para garantir o equilíbrio adequado e pressione o botão INICIAR para redefinir e concluir o protocolo recomendado.

Coloque sempre os tubos em pares e em posições opostas para equilibrar o rotor da centrífuga. Os tubos devem estar sempre equilibrados no rotor antes de pressionar o botão START (INICIAR) ou isto pode causar danos graves na centrífuga, coagulação e/ou separação inadequadas. Se os tubos não estiverem adequadamente equilibrados, um terá demasiada vibração durante a centrifugação e resultará num coágulo de fibrina fraco para L-PRF®.

Se tiver um número ímpar de amostras de sangue para centrifugar, coloque um tubo de equilíbrio de tampa branca (por ex., 455001) cheio com água até à linha de enchimento indicada, no lado oposto ao tubo sem par no rotor. Isto permitirá equilibrar corretamente a centrífuga.

Inicie a centrifugação imediatamente após colher as amostras de sangue. Atrasos afetam o procedimento de separação do sangue e resultam em um coágulo de fibrina pobre em L-PRF.

7 PREPARAÇÃO L-PRF

Após a centrifugação, são visíveis três segmentos:

1. Segmento superior = plasma pobre em plaquetas (PPP).
2. Segmento médio = coágulo de fibrina: L-PRF.
3. Segmento inferior = coágulo de glóbulos vermelhos.

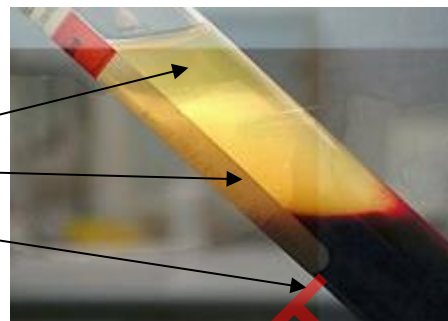

As membranas ou tampões de fibrina L-PRF devem ser preparados relativamente rápido: 0-15 minutos após a centrifugação ou o coágulo encolherá em volume, libertando o soro preso. Após a centrifugação retire a rolha de borracha de cada tubo. Usando o fórceps de tecido cirúrgico, remova o coágulo de L-PRF do tubo. Raspe suavemente o coágulo de glóbulos vermelhos do coágulo de fibrina L-PRF® logo abaixo da união, usando a espátula portadora de biomaterial duplo, de modo que apenas uma quantidade residual mínima de glóbulos vermelhos seja anexada ao coágulo de L-PRF. Coloque o coágulo de fibrina na bandeja perfurada Xpression.

8 PREPARAÇÃO DA MATRIZ DE FIBRINA

Protocolo 1 L-PRF Membrana

Coloque cada um dos coágulos de fibrina na bandeja perfurada Xpression. Quando todos os coágulos de fibrina estiverem colocados, coloque a placa de compressão Xpression e a tampa ponderada Xpression sobre os coágulos de fibrina sem exercer pressão sobre os eles.

Deixe o peso da tampa PRENSAR lentamente o coágulo de fibrina enquanto o exsudado é filtrado na parte inferior da bandeja. Não aplique pressão na tampa pesada. A força gravitacional na tampa pesada irá comprimir delicadamente o coágulo e expulsar o soro do coágulo PRF sem danificar a rede de fibrina.

Aguarde, pelo menos, 5 minutos antes de remover e usar qualquer membrana de fibrina. Não remova nenhuma membrana de fibrina até a altura de utilização. A membrana de fibrina pode permanecer na caixa Xpression por um período de até 3 horas.



Protocolo 2 Plugue L-PRF

Coloque um coágulo de fibrina dentro do cilindro de fabricação do plugue branco. Use o pistão para pressionar lentamente o coágulo dentro do cilindro de fabricação de plugue L-PRF branco. Continue pressionando até que a borda superior do pistão esteja nivelada com a borda superior do cilindro de fabricação de plugue L-PRF branco. Com esta técnica, será possível formar um tampão grosso e redondo de fibrina para a cavidade de extração. Para um único dente, um plugue L-PRF pode ser suficiente. Os pré-molares podem precisar de dois tampões L-PRF® e três tampões L-PRF® podem ser necessários para os molares, dependendo do tamanho do local de extração e do tamanho do coágulo de fibrina criado.

As propriedades de trabalho da L-PRF® proporcionam um excelente meio de utilização em combinação com o seu biomaterial de preferência. Utilizando qualquer um dos seguintes protocolos de mistura, o biomaterial é capturado na matriz de fibrina aumentando o seu manuseamento e capacidade biológica.

Protocolo 3- Mistura de biomaterial /L-PRF

Para criar uma mistura “semelhante a uma massa” que pode ser moldada delicadamente com o instrumento de biomaterial na forma e espessura pretendidas, utilize o seguinte protocolo: Corte delicadamente a membrana de fibrina L-PRF em pedaços pequenos em um prato estéril com a Tesoura Cirúrgica Curvada. Adicione a quantidade desejada de material de enxerto ósseo. Misture completamente a L-PRF® e material de enxerto ósseo. Esta mistura pode ser colocada em defeitos usando a espátula portadora de biomaterial duplo.

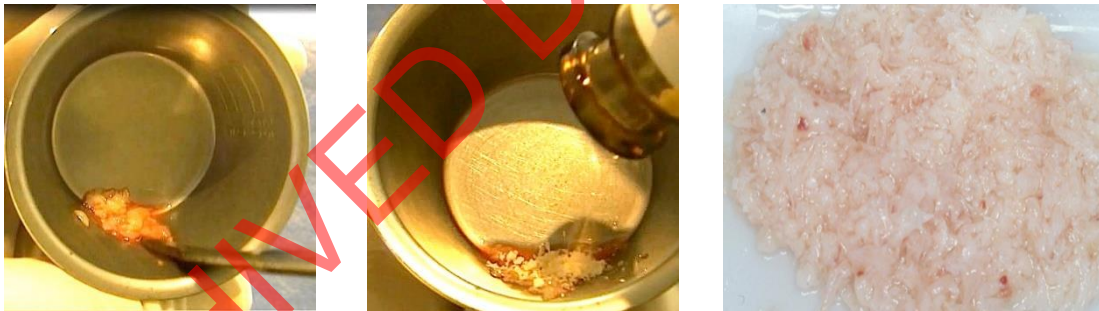

Protocolo 4- Mistura de biomaterial/ matriz L-PRF

Coloque a quantidade predeterminada de material de enxerto ósseo numa bacia ou bandeja estéreis. Mergulhe a (s) membrana (s) de L-PRF expressa (s) ou partes da membrana de L-PRF no material do enxerto que cobre toda a área superficial da membrana do L-PRF com material do enxerto. Em alternativa, o material do enxerto pode ser polvilhado na membrana L-PRF® cobrindo toda a área de superfície com material de enxerto. Nota: uma membrana L-PRF® mais húmida pode reter um pouco mais de material de enxerto do que uma membrana PRF mais seca. O material de enxerto deve aderir à superfície da L-PRF®, mas, se desejar, pressione suavemente o material de enxerto na membrana do L-PRF®. O fórceps de tecido cirúrgico pode ser usado para colocar esta mistura no defeito.

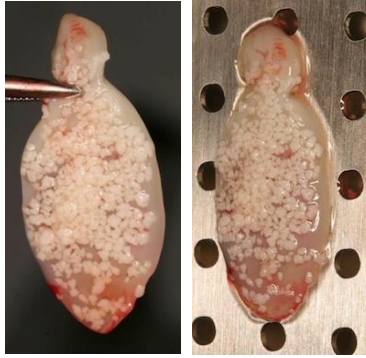

Protocolo 5- Hidratação de Biomateriais

Adicione a quantidade desejada de material de enxerto ósseo em uma tigela ou bandeja estéril. Utilize o exsudado da parte inferior da bandeja de coleta Xpression para hidratar o material do enxerto. Misture bem o exsudado e o material do enxerto ósseo. Esta mistura pode ser colocada em defeitos usando a espátula portadora de biomaterial duplo.



9 LIMPEZA E ESTERILIZAÇÃO DO KIT DE REGENERAÇÃO DE TECIDOS

A caixa Xpression® permite o fabrico de membranas de fibrina de espessura constante com facilidade. O exsudado pode ser coletado da bandeja de coleta do Xpression, abaixo da bandeja perfurada do Xpression. A Xpression Box inclui cilindros de fabricação de plugues L-PRF e um pistão para fabricar plugues L-PRF que se encaixam facilmente nos soquetes de pós-extração.



Tampa Ponderada Xpression



Placa de compressão Xpression



Bandeja perfurada Xpression na bandeja de coleta Xpression

A caixa Xpression e os instrumentos auxiliares NÃO são fornecidos esterilizados. Remova e descarte qualquer material de transporte antes da esterilização inicial. Limpe e esterilize a caixa Xpression e os instrumentos auxiliares antes de cada uso.

Desmonte a caixa Xpression antes de cada ciclo de limpeza e esterilização para evitar o encapsulamento de detritos, descoloração do material e / ou secagem inadequada dos componentes. Os cilindros de fabricação do bujão L-PRF e o anel isolante do pistão não devem ser removidos da bandeja perfurada Xpression para limpeza e esterilização.

Limpeza: (1) Remova todos os detritos visíveis dos componentes e instrumentos auxiliares da caixa Xpression usando uma escova de cerdas macias e um agente de limpeza ou desinfecção de amplo espectro, como o Enzymax® de Hu-Friedy ou equivalente. Enxague bem. (2) Coloque os componentes da caixa Xpression e os instrumentos auxiliares em um recipiente de tamanho adequado da mesma solução e banhamos por 10 minutos. Enxague bem. (3) Enxague os componentes da caixa Xpression e os instrumentos auxiliares com álcool isopropílico para remover qualquer resíduo de sabão e minerais. (4) Seque os componentes da caixa Xpression e os instrumentos auxiliares com uma toalha sem fiapos e seque completamente ao ar. Consulte a etiqueta do agente de limpeza usado para obter instruções de uso.

Esterilização: (1) Coloque a Xpression Box remontada e os instrumentos auxiliares em um saco ou saco de esterilização certificado pela FDA. (2) Execute um dos seguintes ciclos de esterilização qualificados:

Método de esterilização	Temperatura	Período de exposição	Tempo mínimo de secagem
Vapor pré-vácuo (ANSI/AAMI ST79)	132°C (270°F)	4min	20-30 minutos
Vapor pré-vácuo (UK DoH Health Technical Memorandum 01-01)	134°C (273°F)	3min	20-30 minutos

Atenção! Uma limpeza inadequada pode levar a esterilização inadequada. Não seque completamente os componentes e os instrumentos auxiliares da caixa Xpression durante a autoclave, pois a umidade pode causar descoloração e oxidação. O uso de peróxido de hidrogênio ou outros agentes oxidantes danificará a superfície dos componentes da caixa Xpression e dos instrumentos auxiliares. Recomenda-se testes periódicos, limpeza e calibração do equipamento da autoclave para garantir que a unidade permaneça em boas condições de funcionamento.

10 LIMPEZA E MANUTENÇÃO DA CENTRÍFUGA

O dispositivo pode estar contaminado. Desligue a ficha da rede antes da limpeza. As centrífugas, os rotores e os acessórios não devem ser limpos em máquinas de lavar. Só podem ser limpos à mão e desinfetados com líquidos. A temperatura da água deve situar-se entre 20 °C – 25 °C. Apenas detergentes / desinfetantes com pH entre 5 - 8 e que não contenham álcalis cáusticos, peróxidos, compostos de cloro, ácidos e soluções alcalinas podem ser usados. A fim de evitar o aparecimento de corrosão devido aos agentes de limpeza ou desinfetantes, deve ter em total consideração o guia de aplicação do fabricante do agente de limpeza ou desinfetante.

Limpe a caixa da centrífuga e a câmara de centrifugação regularmente, utilizando sabão ou um detergente suave e um pano húmido, se necessário para evitar a corrosão através da aderência de impurezas. Ingredientes de detergentes adequados incluem sabão, surfactantes aniônicos e surfactantes não iônicos. Depois de usar detergentes, retire o resíduo dos detergentes limpando com um pano húmido. As superfícies devem ser secas imediatamente após a limpeza. No caso de formação de água de condensação, seque a câmara centrífuga limpando com um pano absorvente. Esfregue levemente o selo de borracha da câmara centrífuga com pó de talco ou um produto de cuidado de borracha após cada limpeza. A câmara de centrifugação deve ser verificada quanto a danos. Se forem encontrados danos que sejam relevantes para a segurança, a centrífuga não pode continuar a ser colocada em funcionamento. Neste caso, notifique o Serviço de Apoio ao Cliente.

Para desinfeção de superfícies, se materiais infecciosos penetrarem na câmara de centrifugação, esta deve ser desinfetada imediatamente. Ingredientes de desinfetantes adequados incluem etanol, n-propanol, hexanol etílico, surfactantes aniônicos e inibidores de corrosão. Depois de usar desinfetantes, retire o resíduo dos desinfetantes limpando com um pano húmido. As superfícies devem ser secas imediatamente após a desinfeção.

Para remoção de contaminantes radioativos, o agente deve ser especificamente rotulado como sendo um agente para a remoção de contaminantes radioativos. Ingredientes de agentes adequados para a remoção de contaminantes radioativos incluem surfactantes aniônicos, surfactantes não iônicos, etanol polidratado. Depois de remover os contaminantes radioativos, retire o resíduo dos agentes limpando com um pano húmido. As superfícies devem ser secas imediatamente após a remoção dos contaminantes radioativos.

11 ROTOR E ACESSÓRIOS LIMPEZA E MANUTENÇÃO

Para evitar a corrosão e alterações nos materiais, o rotor e os acessórios têm de ser limpos regularmente com sabão ou um agente de limpeza suave e um pano húmido. A limpeza é recomendada, pelo menos, uma vez por semana. Os contaminantes devem ser removidos imediatamente.

Ingredientes de detergentes adequados incluem sabão, surfactantes aniônicos e surfactantes não iônicos. Depois de usar detergentes, retire o resíduo dos detergentes lavando com água (apenas no exterior da centrífuga) ou limpando com um pano húmido. O rotor e os acessórios têm de ser secos imediatamente após a limpeza. Verifique o rotor e os acessórios semanalmente quanto a danos de desgaste e corrosão. O rotor e os acessórios não devem continuar a ser usados se mostrarem sinais de desgaste ou corrosão. Verifique o encaixe firme do rotor semanalmente. Se material infeccioso entrar no rotor ou nos acessórios, estes devem ser desinfetados apropriadamente.

Ingredientes de desinfetantes adequados incluem etanol, n-propanol, hexanol etílico, surfactantes aniônicos e inibidores de corrosão. Depois de usar desinfetantes, retire o resíduo dos desinfetantes lavando com água (apenas no exterior da centrífuga) ou limpando com um pano húmido. O rotor e os acessórios devem ser secos diretamente após a desinfeção.

Para remoção de contaminantes radioativos, o agente deve ser especificamente rotulado como sendo um agente para a remoção de contaminantes radioativos. Ingredientes de agentes adequados para a remoção de contaminantes radioativos incluem surfactantes aniônicos, surfactantes não iônicos e etanol polidratado.

Depois de remover os contaminantes radioativos, retire o resíduo dos agentes lavando com água (apenas no exterior da centrífuga) ou limpando com um pano húmido. O rotor e os acessórios devem ser secos diretamente após a remoção dos contaminantes radioativos.

O rotor pode ser esterilizado em autoclave a 121 °C/250 °F por 20 minutos e seco adequadamente. Após 10 ciclos de esterilização em autoclave, o rotor deve ser trocado por razões de segurança. A autoclave acelera o processo de envelhecimento dos plásticos e pode causar descoloração. Após a autoclave, aguarde até o rotor esfriar até a temperatura ambiente antes de usá-lo novamente. Nenhuma declaração pode ser feita sobre o grau de esterilidade.

O período de utilização do rotor é limitado a 50.000 ciclos de operação (operações de centrifugação) ou 5 anos, o que ocorrer primeiro. O número máximo permitido de ciclos de execução pode ser visto no rotor. Por razões de segurança, o rotor não pode continuar a ser utilizado quando o número máximo permitido de ciclos de execução (marcados no mesmo) tiver sido atingido. O dispositivo está equipado com um contador de ciclos, que contabiliza os ciclos de execução (ciclos de centrifugação).

No caso de fratura do tubo sanguíneo, todas as partes quebradas e o sangue devem ser completamente removidos. A centrífuga deve ser cuidadosamente limpa conforme indicado e as inserções de borracha e as mangas de plástico do rotor devem ser substituídas.

12 ESPECIFICAÇÕES TÉCNICAS DA CENTRÍFUGA

Tipo de modelo	IS220Z	IS110Z
Tensão de rede ($\pm 10\%$)	200 - 240 V 1~	100 - 127 V 1~
Frequência da rede	50 - 60 Hz-	50 - 60 Hz
Carga ligada	100 VA	100 VA
Consumo de corrente	0.5 A	1.0 A
Capacidade	8 x 10 ml	
Densidade máxima permitida	1.2 kg/dm ³	
Velocidade máxima (RPM)	6,000	
Força (RCF)	3,461	
Energia cinética	750 Nm	
Local de instalação	Apenas no interior	
Altitude	Até 2000 m acima do nível do mar	
Temperatura ambiente para operação	5°C a 40°C	
Humidade relativa para operação	Humidade relativa máxima de 80% para temperaturas até 31 °C, diminuindo linearmente para 50% de humidade relativa a	
Categoria de sobretensão	II	
Grau de poluição	2	
Classe de proteção do dispositivo	I	
	Não é adequado para utilização em áreas com perigo de	

Interferência emitida, Imunidade a interferências	EN / IEC 61326-1, Classe B	FCC Classe B
Nível de ruído (dependente do rotor)	≤ 50 dB(A)	
Largura da centrífuga	261 mm	
Profundidade da centrífuga	353 mm	
Altura da centrífuga	228 mm	
Peso da centrífuga	aprox. 9 kg	

ARCHIVED DOCUMENT

13 INSTRUÇÕES DE OPERAÇÃO CENTRÍFUGAS

É imperativo que o dispositivo de segurança de transporte, composto por 2 parafusos (a) e 2 espaçadores (b), seja removido. Mantenha o dispositivo de segurança de transporte num local seguro, visto que tem de ser instalado novamente antes de transportar o dispositivo. O dispositivo só pode ser transportado com o dispositivo de segurança de transporte instalado. Para proteger o dispositivo contra danos durante o transporte, o motor é fixado no lugar. Este dispositivo de segurança de transporte deve ser removido quando o dispositivo é colocado em funcionamento.

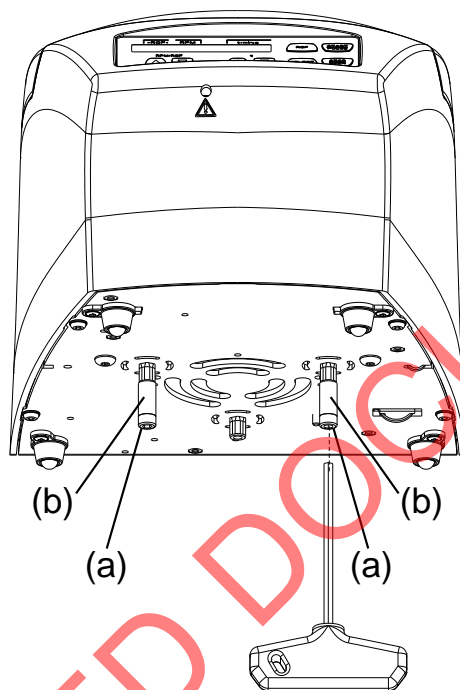

13.1 OPERAÇÃO INICIAL

- Remova o dispositivo de segurança de transporte do lado inferior da centrífuga.
- Posicione a centrífuga num lugar apropriado estável e nivelado. Quando a centrífuga estiver a funcionar, nenhuma pessoa, substâncias perigosas ou objetos podem estar dentro da margem de segurança de 300 mm em redor da centrífuga.
- As aberturas de ventilação não podem estar bloqueadas. Uma distância de 300 mm deve ser mantida a partir das ranhuras de ventilação e aberturas da centrífuga.
- Verifique se a tensão da rede corresponde à indicação na placa de características.
- Ligue a centrífuga com o cabo de alimentação a uma tomada de corrente padrão.
- Ligue o interruptor de rede.
- Os seguintes displays aparecem no painel: o tipo de modelo da centrífuga, a versão do software e os últimos dados de centrifugação usados.
- Se a tampa estiver fechada, é apresentada a mensagem “Open the lid” (Abrir a tampa). Neste caso, abra a tampa para visualizar os dados de centrifugação.

13.2 ABRIR E FECHAR A TAMPA CENTRÍFUGA

A tampa só pode ser aberta se a centrífuga estiver ligada e o rotor parado. Quando o contador de ciclos é ativado, depois de um ciclo de centrifugação, ao abrir a tampa, o número restante de ciclos de funcionamento (ciclos de centrifugação) é brevemente apresentado.

Exemplo: 

Para abrir a tampa, pressione a seguinte tecla



. A tampa é destrancada pelo motor.  indica tampa destrancada.

Exemplo: 

Não coloque os dedos entre a tampa e a caixa. Não bata a tampa para fechar.

Para fechar a tampa, pressione levemente a borda frontal da tampa.  indica tampa trancada.

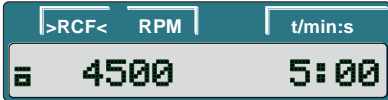
Exemplo: 

13.3 DESBLOQUEIO DE EMERGÊNCIA

No caso de uma falha de energia, a tampa não pode ser desbloqueada com o motor. O desbloqueio de emergência deve ser feito à mão. Para desbloquear em uma emergência, desligue o interruptor da rede (definição do interruptor "0"). Olhe através da janela na tampa para se certificar de que o rotor está imobilizado. Abra a tampa apenas quando o rotor estiver parado. Insira a chave Allen horizontalmente no orifício (A) e rode com cuidado no sentido anti-horário (para a esquerda) até a tampa abrir. CUIDADO! Girar a chave Allen sextavada no sentido horário (para a direita) pode danificar o sistema de travamento. Retire a chave Allen do orifício.

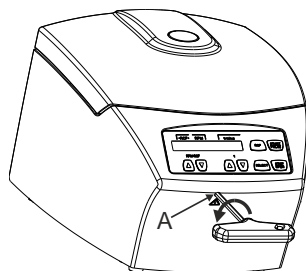

13.4 INSTALAÇÃO E REMOÇÃO DO ROTOR

Para remover o rotor, desaperte a porca de aperto do rotor rodando no sentido anti-horário com a chave Allen (incluída no fornecimento) e rode-a até ao ponto de pressão de elevação. Depois de ultrapassar o ponto de pressão de elevação, o rotor é libertado do cone do eixo do motor. Rode a porca de aperto até que o rotor possa ser levantado do eixo do motor. Levante o rotor do eixo do motor.

Para instalar o rotor, limpe o eixo do motor (A) e o orifício do rotor e, em seguida, aplique uma camada fina de massa no eixo do motor. As partículas de sujidade entre o eixo do motor e o rotor impedem que o rotor tenha um assento perfeito e causam um funcionamento instável. Coloque o rotor verticalmente no eixo do motor. Ao colocar o rotor, o feixe de marcação (B) no rotor deve ficar paralelo a ambas as superfícies (C) no eixo do motor. Aperte a porca de aperto do rotor com a chave Allen (incluída no fornecimento) rodando no sentido horário. Verifique o rotor para se certificar de que está firmemente encaixado.

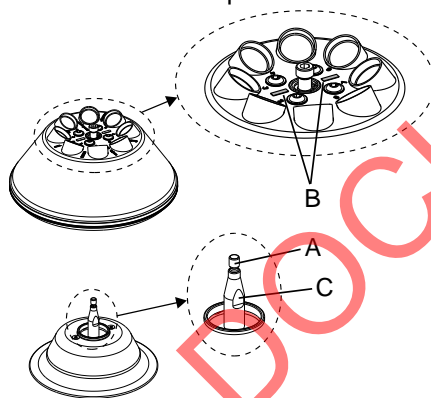

Os rotores devem ser carregados simetricamente. Os tubos de sangue devem ser distribuídos uniformemente em todas as posições do rotor.

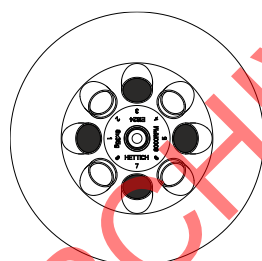

O rotor está carregado uniformemente

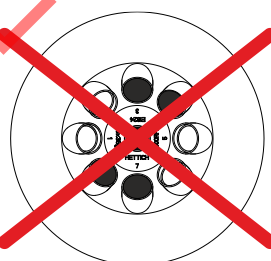

O rotor não está carregado uniformemente
Não é permitido!

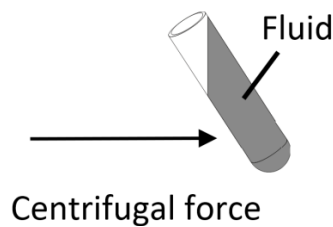

Os tubos de sangue só podem ser depositados fora da centrífuga. A quantidade máxima de enchimento para os tubos de sangue é especificada nos próprios tubos e não deve exceder o peso máximo listado no rotor. Os recipientes de centrifugação só podem ser enchidos até que nenhum fluido possa ser expelido dos mesmos enquanto a centrífuga está a funcionar. Ao carregar o rotor, nenhum líquido pode entrar no rotor ou na câmara de centrifugação. Para manter as diferenças de peso dentro do recipiente da centrífuga o mais marginal possível, recomenda-se um nível de enchimento consistente nos tubos de sangue.

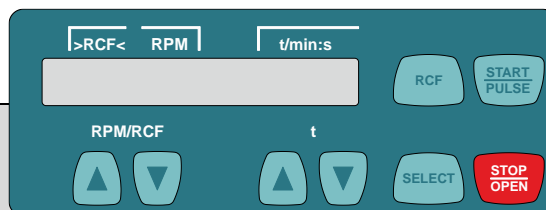

13.5 DESCRIÇÃO DOS ELEMENTOS DO VISOR



Símbolo / Tecla do painel	Descrição
	Tampa destrancada.
	Tampa trancada.
	Indicação das rotações. A indicação das rotações ilumina-se, rodando no sentido anti-horário, quando o rotor está girando.
	Introduza a velocidade diretamente. Se a tecla for mantida pressionada, o valor muda com o aumento da velocidade.
	Introduza o tempo de execução diretamente. Ajustável em incrementos de 1 segundo até um minuto, e em incrementos de 1 minuto a partir de 1 minuto. Introduza os parâmetros de centrifugação. Se a tecla for mantida pressionada, o valor muda com o aumento da velocidade.
	Para ativar parâmetros individuais. Cada vez que a tecla é pressionada, o parâmetro seguinte é ativado. Mantenha a tecla pressionada durante 8 segundos para chamar o "MACHINE MENU" (MENU DA MÁQUINA). No "Machine menu" (Menu da máquina), selecione os menus "-> Info", "-> Settings" e "-> Time & Cycles" (Informação > Definições > Tempo e ciclos). Percorra os menus.
	Para alternar entre o indicador de velocidade (RPM) e o indicador de força centrífuga relativa (>RCF<). Os valores RCF são exibidos entre as setas ><.
	Inicie o ciclo de centrifugação. Centrifugação a curto prazo. A centrifugação é executada desde que a tecla seja mantida pressionada. Para selecionar os menus "->Info", "->Settings" e "->Time & Cycles" (Informação > Definições > Tempo e ciclos).
	Termine o ciclo de centrifugação. O rotor reduz com uma fase de travagem pré-selecionada. Pressionar a tecla duas vezes aciona a paragem de emergência. Destranque a tampa.
t/min	Tempo de execução. Ajustável entre 1 - 99 min, em incrementos de 1 minuto.
t/sec	Tempo de execução. Ajustável entre 1 - 59 s, em incrementos de 1 segundo. Execução contínua "--:--". Defina os parâmetros t/min e t/sec para zero.
RPM	Velocidade. É possível definir um valor numérico de 200 rpm para a velocidade máxima do rotor. Ajustável em incrementos de 10.
>RCF<	Força centrífuga relativa. É possível definir um valor numérico que resulte numa velocidade entre 200 rpm e a velocidade máxima do rotor. Ajustável em incrementos de 1.

	Só é possível introduzir a força centrífuga relativa (RCF) se a visualização RCF (>RCF<) for ativada. A força centrífuga relativa (RCF) depende do raio de centrifugação (RAD). Depois de introduzir a RCF, certifique-se de que o raio de centrifugação correto foi definido.
RAD/mm	Raio de centrifugação. Ajustável de 10 mm a 250 mm, em incrementos de 1 mm. Só é possível introduzir o raio de centrifugação se a visualização RCF (>RCF<) for ativada.
~_DEC	Etapa do travão. fast (rápido) = tempo esgotado curto, slow (lento) = tempo esgotado longo.

13.6 INTRODUÇÃO DIRETA DOS PARÂMETROS DE CENTRIFUGAÇÃO

A velocidade (RPM), a força centrífuga relativa (RCF), o raio de centrifugação (RAD) e o tempo de execução podem ser inseridos diretamente com as teclas   sem antes ter que pressionar a tecla . Os parâmetros de centrifugação definidos são armazenados apenas após ter começado o ciclo de centrifugação.

Para Velocidade (RPM):



Pressione a tecla para ativar a visualização RPM (RPM), conforme necessário.

RPM/RCF



Defina o valor desejado com as teclas.

Exemplo:

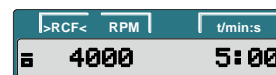

Para força centrífuga relativa (RCF) e raio de centrifugação (RAD):



Pressione a tecla para ativar a visualização RCF (>RCF<), conforme necessário.

RPM/RCF



Defina o valor RCF desejado com as teclas.

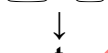

t



Defina o raio de centrifugação pretendido com as teclas, conforme necessário.

Exemplo:

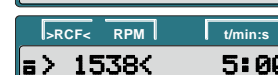

Tempo de execução:

Até 1 minuto, o tempo de execução pode ser definido em incrementos de 1 segundo, e a partir de 1 minuto, só pode ser definido em incrementos de 1 minuto. Para definir a execução contínua, os parâmetros **t/min** e **t/sec** (t/s) devem ser definidos como zero. Na visualização do tempo (t/min:s), aparece "--:--".





t Defina o valor desejado com as teclas.





13.7 INTRODUÇÃO DOS PARÂMETROS DE CENTRIFUGAÇÃO COM A TECLA “SELECT” (SELECIONAR)

O tempo de execução pode ser definido em minutos e segundos (parâmetros **t/min** e **t/sec** [t/s]). Para definir a execução contínua, os parâmetros **t/min** e **t/sec** devem ser definidos como zero. Na visualização do tempo (t/min:s), aparece “--:--”.

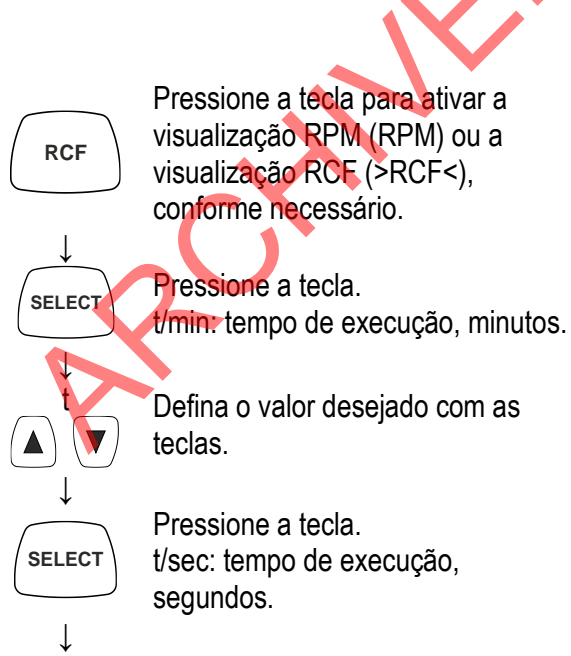

A força centrífuga relativa (RCF) depende do raio de centrifugação (RAD). Durante a introdução da RCF, o raio de centrifugação definido é exibido. Se nenhuma tecla for pressionada durante 8 segundos após a seleção ou durante a introdução do parâmetro, os valores anteriores são mostrados no visor. Os parâmetros devem, então, ser introduzidos novamente. Pressionando o botão , as definições serão guardadas. Se vários parâmetros forem introduzidos, a tecla  deve ser pressionada após a definição do último parâmetro. A introdução dos parâmetros pode ser cancelada a qualquer momento pressionando a tecla . Neste caso, as definições não são armazenadas.



Exemplo: Visualização (RPM)

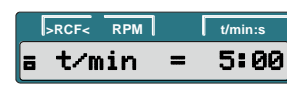

Exemplo: Visualização (>RCF<)

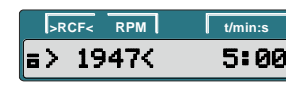

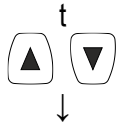

Defina o valor desejado com as teclas.



Pressione a tecla.
RPM: velocidade.
RAD/mm: raio de centrifugação.
Só é possível visualizar e introduzir o raio de centrifugação se a visualização RCF (>RCF<) for ativada.

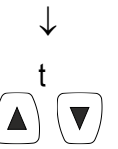
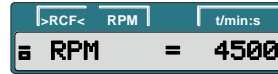

Defina o valor desejado com as teclas.

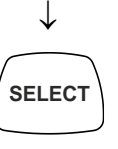

Pressione a tecla.
R: raio de centrifugação.
RCF: força centrífuga relativa

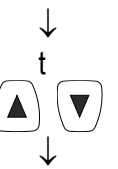

Defina o valor desejado com as teclas.



Pressione a tecla.
_DEC: etapa do travão.
fast (rápido): tempo esgotado curto.
slow (lento): tempo esgotado longo.

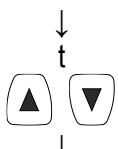

Defina o valor desejado com as teclas.

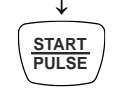

Pressione o botão para guardar as definições.



13.8 VISOR DO PAINEL DE CONTROLE

Depois de cada ciclo de centrifugação, enquanto a tampa é destrancada, o número restante de ciclos de execução (ciclos de centrifugação) será brevemente apresentado.

Exemplo: The screenshot shows a control panel with three buttons at the top: '>RCF<', 'RPM', and 't/min:s'. The main display area shows the text 'RemCycles= 16703'.

Se a diferença de peso admissível for excedida dentro da carga do rotor, o ciclo de centrifugação é abortado durante o arranque e "IMBALANCE" será exibido.

Exemplo: The screenshot shows the control panel with the same three buttons at the top. The main display area shows the text 'IMBALANCE'.

Um ciclo de centrifugação pode ser abortado a qualquer momento pressionando a tecla . Durante um ciclo de centrifugação, os parâmetros de centrifugação podem ser selecionados e alterados. Os valores alterados, no entanto, só se aplicam ao ciclo de centrifugação atual e não são guardados.

Com a tecla , pode alternar entre a visualização RPM (RPM) e a visualização RCF (>RCF<) a qualquer momento. Se a visualização RCF (>RCF<) for a selecionada, o raio de centrifugação deve ser introduzido. A continuação do funcionamento da centrífuga só é possível após a abertura da tampa. Serão apresentados erros e avarias de funcionamento.

Exemplo: The screenshot shows the control panel with the same three buttons at the top. The main display area shows the text 'Open the lid'.

13.9 CENTRIFUGAÇÃO COM TEMPO PREDEFINIDO

Pressione a tecla para ativar a visualização RPM (RPM) ou a visualização RCF (>RCF<), conforme necessário.





Introduza os parâmetros de centrifugação desejados



Pressione a tecla para iniciar o ciclo de centrifugação. Durante o ciclo de centrifugação, a velocidade do rotor ou o valor RCF resultante e o tempo restante são apresentados.



Após o tempo decorrido ou se o ciclo de

centrifugação for abortado premindo a tecla  o tempo esgotado ocorre com a etapa de travão definida. A etapa de travão é apresentada 

Exemplo:
Visualização (RPM)

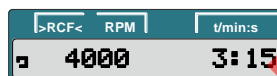
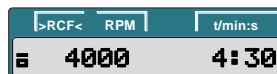
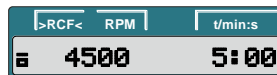

Exemplo:
Visualização (>RCF<)

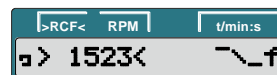
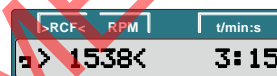

13.10 EXECUÇÃO CONTÍNUA

Pressione a tecla para ativar a visualização RPM (RPM) ou a visualização RCF (>RCF<), conforme necessário.



Introduza os parâmetros de centrifugação pretendidos. Defina os parâmetros t/min e t/sec (t/s) para zero



Pressione a tecla para iniciar o ciclo de centrifugação. Durante o ciclo de centrifugação, a velocidade do rotor ou o valor RCF resultante e o tempo restante são apresentados.



Exemplo:
Visualização (RPM)

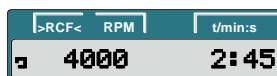
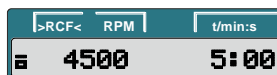

Exemplo:
Visualização (>RCF<)

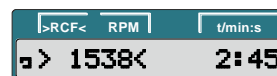
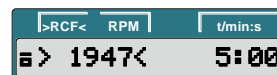



Pressione a tecla para terminar o ciclo de centrifugação.

O tempo esgotado ocorre com a etapa do travão definida. A etapa do travão é apresentada \sim f

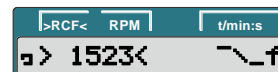

13.11 CENTRIFUGAÇÃO A CURTO PRAZO



Pressione a tecla para ativar a visualização RPM (RPM) ou a visualização RCF (>RCF<), conforme necessário.

Exemplo:
Visualização (RPM)

Exemplo:
Visualização (>RCF<)

Introduza os parâmetros de centrifugação desejados



Pressione a tecla e mantenha-a pressionada. Durante o ciclo de centrifugação, a velocidade do rotor ou o valor RCF resultante e o tempo decorrido são apresentados.

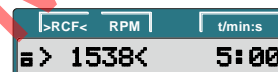
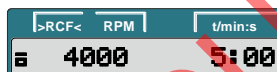

Solte a tecla novamente para terminar o ciclo de centrifugação.



O tempo esgotado ocorre com a etapa do travão definida. A etapa de travão é apresentada \sim f

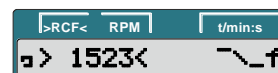
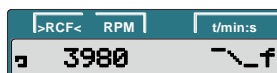
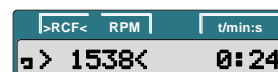
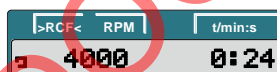

13.12 PARAGEM DE EMERGÊNCIA



Pressione a tecla duas vezes. Durante a paragem de emergência, o tempo esgotado ocorre com a etapa do travão "fast" (rápido) (tempo esgotado curto). A etapa do travão \sim f é apresentada.

Exemplo:
Visualização (RPM)

Exemplo:
Visualização (>RCF<)

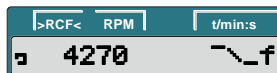

13.13 CONTADOR DE CICLOS

A centrífuga está equipada com um contador de ciclos, que contabiliza os ciclos de execução (ciclos de centrifugação). Depois de cada ciclo de centrifugação, enquanto a tampa é destrancada, o número restante de ciclos de execução (ciclos de centrifugação) será brevemente apresentado.

Exemplo: 

Se o número máximo admissível de ciclos de execução do rotor tiver sido excedido, é apresentado o seguinte sempre que o ciclo de centrifugação é iniciado e o ciclo de centrifugação deve ser reiniciado. O rotor deve ser imediatamente trocado por um novo rotor por razões de segurança. Após o rotor ter sido trocado, o contador de ciclos deve ser reposto para "0".

Exemplo: 

13.14 REPOR O CONTADOR DE CICLOS PARA ZERO

Após o rotor ter sido trocado, o contador de ciclos deve ser reposto a zero novamente. O contador de ciclos só pode ser reposto a zero se o rotor tiver sido trocado por um novo rotor primeiro. Com o rotor parado, o contador de ciclos pode ser reposto da seguinte forma. O procedimento pode ser abortado a qualquer momento pressionando a tecla . Neste caso, as definições não são armazenadas.

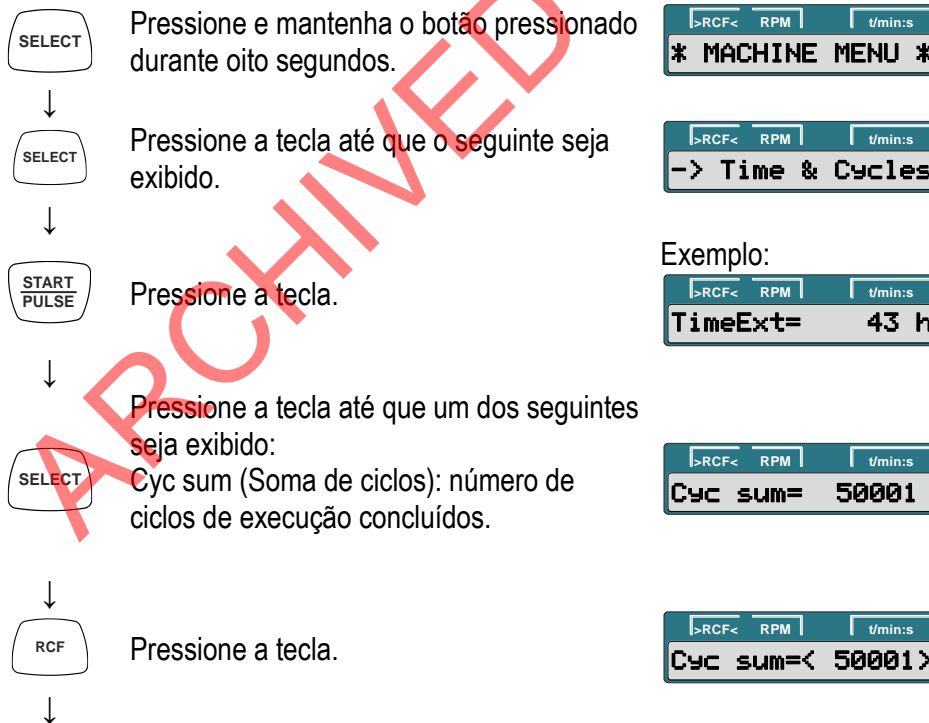

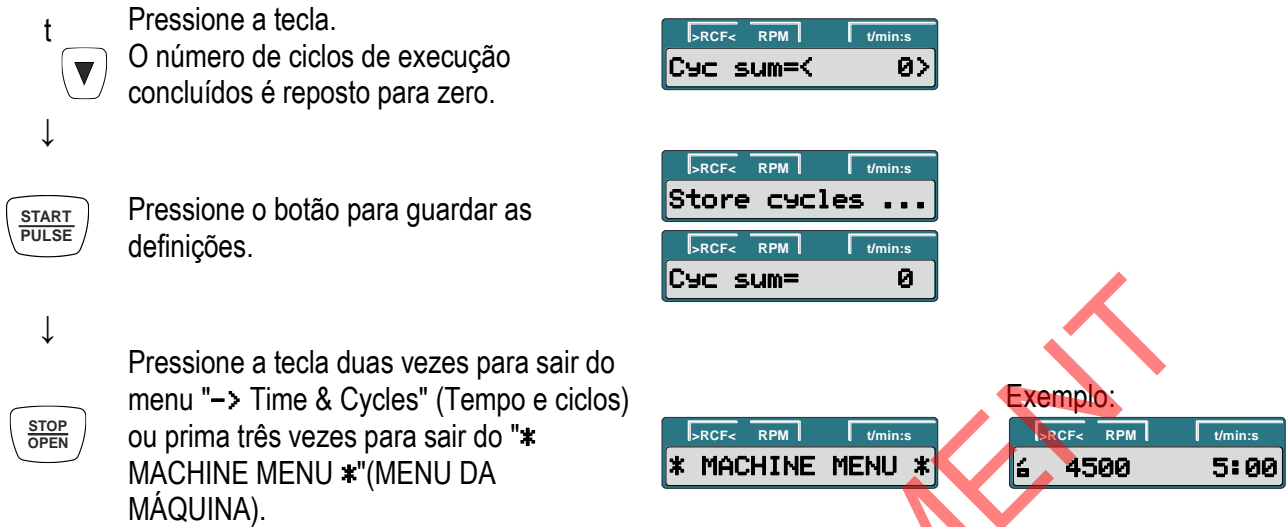

13.15 DEFINIÇÕES E CONSULTAS

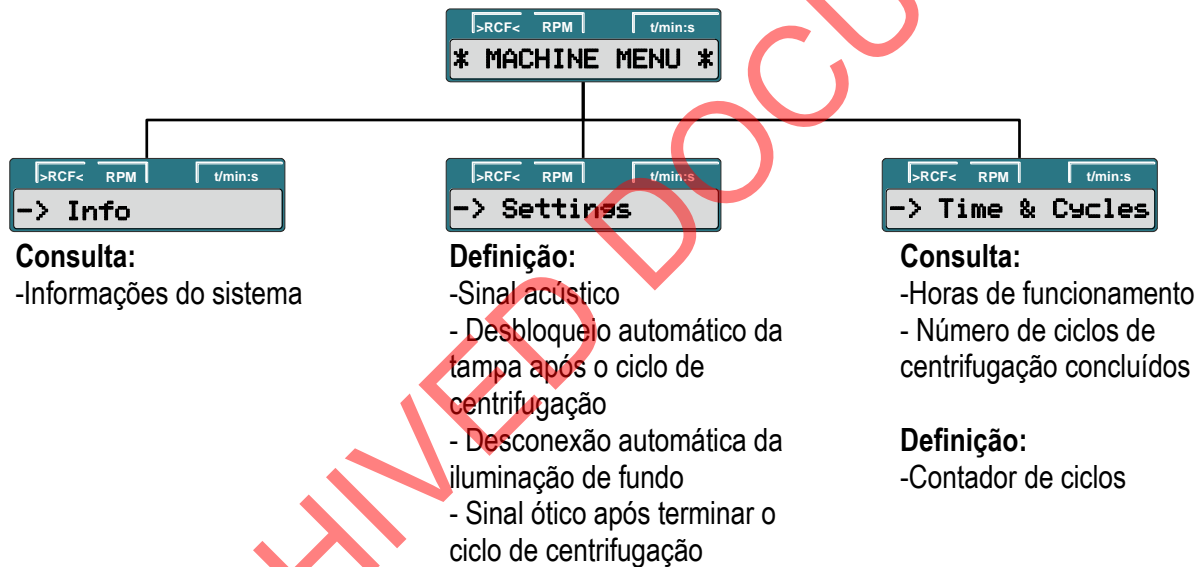

13.16 A CONSULTAR AS INFORMAÇÕES DO SISTEMA

As seguintes informações do sistema podem ser consultadas:

- Modelo do dispositivo
- Versão do programa do dispositivo
- Número do tipo do dispositivo
- Data de fabrico do dispositivo
- Número de série do dispositivo
- Tipo do conversor de frequência
- Versão do programa do conversor de frequência

Com o rotor parado, a consulta pode prosseguir da seguinte forma: O procedimento pode ser abortado a qualquer momento pressionando a tecla .

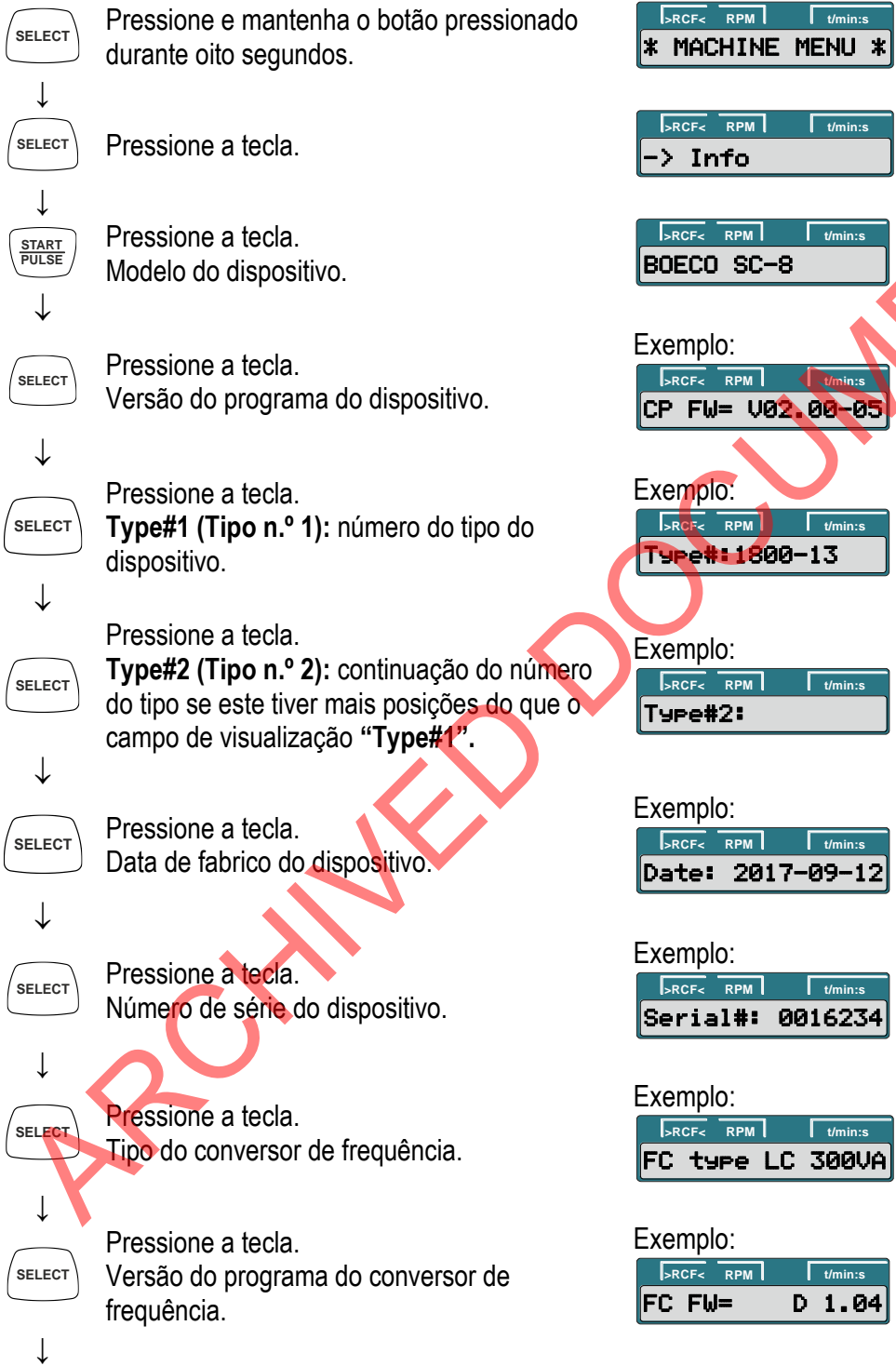



Pressione a tecla duas vezes para sair do "-> Info" (Informações) ou prima três vezes para sair do "* MACHINE MENU *(MENU DA MÁQUINA).



Exemplo:

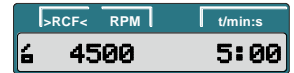

13.17 SINAL ACÚSTICO

O sinal acústico soa: (1) após uma avaria ocorrer num intervalo de 2 segundos; (2) depois de terminar o ciclo de centrifugação e o rotor estar parado num intervalo de 30 segundos. O sinal acústico é terminado pressionando qualquer tecla. Se o rotor estiver parado, o sinal acústico pode ser ajustado da seguinte

forma. O procedimento pode ser abortado a qualquer momento pressionando a tecla . Neste caso, as definições não são armazenadas.



Pressione e mantenha o botão pressionado durante oito segundos.



Pressione a tecla até que o seguinte seja exibido.



Pressione a tecla.



End beep (Terminar bip): sinal acústico após terminar o ciclo de centrifugação.
off (desligado): sinal desativado.
on (ligado): sinal ativado.



Com as teclas, defina **off** ou **on**.



Pressione a tecla.

Error beep (Bip de erro): sinal acústico após a ocorrência de uma avaria.
off: sinal desativado.
on: sinal ativado.



Com as teclas, defina **off** ou **on**.



Pressione a tecla.

Beep volume (Volume do bip): volume do sinal acústico.
min (mín.): suave
mid (médio): médio
max (máx.): alto



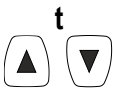

Com as teclas, defina **min**, **mid** ou **max**.

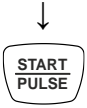

Pressione o botão para guardar as definições.



Pressione a tecla uma vez para sair do menu "-> Settings (Definições) ou prima duas vezes para sair do "* MACHINE MENU *" (MENU DA MÁQUINA).

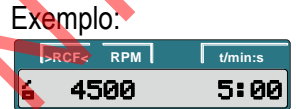

13.18 SINAL ÓTICO APÓS TERMINAR O CICLO DE CENTRIFUGAÇÃO

A retroiluminação do visor pisca após o ciclo de centrifugação para sinalizar visualmente que o ciclo de centrifugação terminou. O sinal ótico pode ser ligado ou desligado quando o rotor está parado. O procedimento pode ser abortado a qualquer momento pressionando a tecla .



Pressione e mantenha o botão pressionado durante oito segundos.

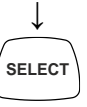

Pressione a tecla até que o seguinte seja exibido.

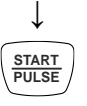

Pressione a tecla.

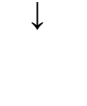

Pressione a tecla até que um dos seguintes seja exibido:

End blinking (Parar de piscar): a retroiluminação do visor pisca após o ciclo de centrifugação.



off (desligada): a retroiluminação não pisca.

on (ligada): a retroiluminação pisca.

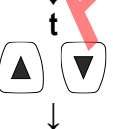

Com as teclas, defina **off** ou **on**.





Pressione o botão para guardar as definições.



Pressione a tecla uma vez para sair do menu "-> Settings (Definições) ou prima duas vezes para sair do "* MACHINE MENU *" (MENU DA MÁQUINA).



Exemplo:



13.19 DESBLOQUEIO AUTOMÁTICO DA TAMPA APÓS O CICLO DE CENTRIFUGAÇÃO

É possível definir se a tampa deve destrancar automaticamente ou não depois do ciclo de centrifugação. Com o rotor parado, isto pode ser definido da seguinte forma. O procedimento pode ser abortado a qualquer momento pressionando a tecla . Neste caso, as definições não são armazenadas.



Pressione e mantenha o botão pressionado durante oito segundos.



Pressione a tecla até que o seguinte seja exibido.



Pressione a tecla.



Pressione a tecla até que um dos seguintes seja exibido:



Lid AutoOpen (Abrir tampa automaticamente): desbloqueio automático da tampa após o ciclo de centrifugação.



off (desligada): a tampa não destranca automaticamente.

on (ligada): a tampa destranca automaticamente.

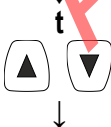

Com as teclas, defina **off** ou **on**.





Pressione o botão para guardar as definições.



Pressione a tecla uma vez para sair do menu "-> Settings (Definições)" ou prima duas vezes para sair do "* MACHINE MENU *" (MENU DA MÁQUINA).



Exemplo:



13.20 RETROILUMINAÇÃO DO VISOR

Para poupar energia, pode-se definir que, após um ciclo de centrifugação, a retroiluminação do visor se desliga após 2 minutos. Com o rotor parado, isto pode ser definido da seguinte forma. O procedimento pode ser abortado a qualquer momento pressionando a tecla . Neste caso, as definições não são armazenadas.



Pressione e mantenha o botão pressionado durante oito segundos.

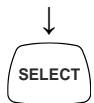

Pressione a tecla até que o seguinte seja exibido.

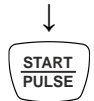

Pressione a tecla.



Pressione a tecla até que um dos seguintes seja exibido:



Power save (Poupança de energia): encerramento automático da retroiluminação.



off (desligado): encerramento automático desativado.

on (ligado): encerramento automático ativado

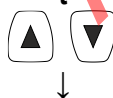

Com as teclas, defina **off** ou **on**.





Pressione o botão para guardar as definições.



Pressione a tecla uma vez para sair do menu "-> Settings (Definições)" ou prima duas vezes para sair do "* MACHINE MENU *" (MENU DA MÁQUINA).



Exemplo:



13.21 CONSULTAR AS HORAS DE FUNCIONAMENTO E O NÚMERO DE CICLOS DE CENTRIFUGAÇÃO

As horas de funcionamento são divididas em horas internas e externas de funcionamento. Horas internas de funcionamento: tempo total que o dispositivo esteve ligado. Horas externas de funcionamento: tempo total dos ciclos de centrifugação anteriores. Com o rotor parado, a consulta pode prosseguir da seguinte

forma. O procedimento pode ser abortado a qualquer momento pressionando a tecla .



Pressione e mantenha o botão pressionado durante oito segundos.



Pressione a tecla até que o seguinte seja exibido.



Pressione a tecla.
TimeExt (Tempo externo): horas externas de funcionamento.

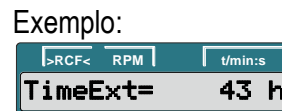

Exemplo:



Pressione a tecla.
TimeInt (Tempo interno): horas internas de funcionamento.

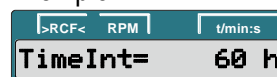

Exemplo:



Pressione a tecla.
Starts (Inícios): número de todos os ciclos de centrifugação.

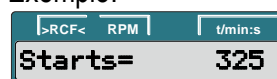

Exemplo:



Pressione a tecla duas vezes para sair do menu "-> Time & Cycles (Tempo e ciclos)" ou prima três vezes para sair do "* MACHINE MENU *" (MENU DA MÁQUINA).



Exemplo:





14 FALHAS

Se a falha não puder ser eliminada com a ajuda da tabela de falhas abaixo, entre em contacto com o Atendimento ao cliente e especifique o tipo de centrífuga e o número de série. Ambos os números podem ser encontrados na placa de características da centrífuga.

Efetuar uma MAINS RESET (REPOSIÇÃO ELÉTRICA): Desligue o interruptor de rede (posição do interruptor "0"). Aguarde pelo menos 10 segundos e, em seguida, ligue novamente o interruptor de rede (posição do interruptor "I").

Mensagem/falha		Causa	Solução
Sem visor		Sem tensão Fusíveis de entrada de rede defeituosos.	<ul style="list-style-type: none"> – Verifique a tensão de distribuição. – Verifique o fusível da entrada de energia elétrica e consulte as instruções para trocar o fusível da rede elétrica. – Interruptor de rede ligado.
IMBALANCE (DESEQUILÍBRIO)		O rotor não está carregado uniformemente.	<ul style="list-style-type: none"> – Abra a tampa apenas quando o rotor estiver parado. – Verifique a carga do rotor. – Repita o ciclo de centrifugação..
MAINS INTER (INTERR. DA REDE)	11	Falha de energia durante o ciclo de centrifugação. (O ciclo de centrifugação não foi terminado.)	<ul style="list-style-type: none"> – Abra a tampa apenas quando o rotor estiver parado – Prima o botão start/pause – Repita o ciclo de centrifugação, se necessário.
MAINS INTERRUPT (INTERRUPÇÃO DA REDE)			
TACHO ERROR (ERRO DO TACO)	1, 2	Falha de impulsos de velocidade durante o funcionamento.	<ul style="list-style-type: none"> – Efetue uma MAINS RESET quando o rotor estiver parado.
LID ERROR (ERRO DA TAMPA)	4.1 – 4.127	Erro no bloqueio da tampa ou fecho da tampa.	
OVER SPEED (VELOCIDADE EXCESSIVA)	5	Rotação muito rápida	
VERSION ERROR (ERRO DE VERSÃO)	12	Modelo de centrífuga incorreto reconhecido. Erro/defeito dos componentes eletrónicos	<ul style="list-style-type: none"> – Efetue uma MAINS RESET quando o rotor estiver parado.
UNDER SPEED (VELOCIDADE REDUZIDA)	13	Rotação muito lenta	
CTRL ERROR (ERRO DE CTRL)	22.1, 25.2	Erro/defeito dos componentes eletrónicos	
CRC ERROR (ERRO CRC)	27.1		

COM ERROR (ERRO COM)	31 – 36		
FC ERROR (ERRO FC)	60, 61.1 – 61.21, 61.64 – 61.142		
FC ERROR (ERRO FC)	61.23	Erro de medição de velocidade	<ul style="list-style-type: none"> – O dispositivo não pode ser desligado enquanto o visor de rotações  O dispositivo não pode ser desligado enquanto o visor de rotações  (tampa bloqueada) seja apresentado (após aprox. 120 segundos). Depois, realize uma MAINS RESET.
TACHO ERR (ERRO DO TACO)	61.22		
FC ERROR (ERRO FC)	61.153	Erro/defeito dos componentes eletrônicos	<ul style="list-style-type: none"> – Efetue uma MAINS RESET. – Verifique o carregamento do rotor de acordo com as instruções fornecidas. – Repita o ciclo de centrifugação.

15 FORÇA CENTRÍFUGA RELATIVA (RCF)

A força centrífuga relativa (RCF) é dada como um múltiplo da aceleração da gravidade (g). É um valor sem unidade e serve para comparar o desempenho da separação e da sedimentação. A força centrífuga relativa (RCF) relaciona-se com as rotações por minuto e o raio centrífugo. Pode ser calculado usando a fórmula abaixo:

$$RCF = \left(\frac{RPM}{1000} \right)^2 \times r \times 1,118 \quad \Rightarrow \quad RPM = \sqrt{\frac{RCF}{r \times 1,118}} \times 1000$$

RCF = força centrífuga relativa

RPM = velocidade de rotação (rotações por minuto)

r = raio centrífugo em mm = distância do centro do eixo de rotação ao fundo do recipiente da centrífuga.

16 TRANSPORTE E ARMAZENAMENTO

Antes de transportar o dispositivo, o dispositivo de fixação do transporte deve ser instalado. O dispositivo e os acessórios só podem ser guardados em compartimentos fechados e secos. Quando o dispositivo e os acessórios são transportados ou armazenados, as seguintes condições devem ser cumpridas:

Temperatura ambiente: -20 °C a +60 °C.

Humidade relativa: 10% a 80%, sem condensação.

17 TROCAR OS FUSÍVEIS DE ENTRADA DA REDE

Comece desligando o interruptor principal e separando o dispositivo da rede elétrica. O porta-fusíveis (A) com os fusíveis de entrada de rede está localizado junto ao interruptor de rede. Retire o cabo de ligação da tomada da máquina. Pressione o encaixe (B) contra o porta-fusível (A) e retire-o. Troque os fusíveis de entrada de rede defeituosos. Use apenas fusíveis com a classificação definida para o tipo de centrífuga

fornecida pelo fabricante. Reinsira o porta-fusíveis até ouvir os cliques de encaixe. Volte a ligar o dispositivo à alimentação de rede.

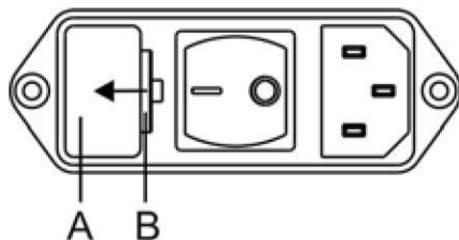

18 DEVOLVER DISPOSITIVOS

Antes de devolver o dispositivo, o dispositivo de segurança de transporte deve ser instalado. Se o dispositivo ou seus acessórios forem devolvidos ao fabricante legal, a fim de proteger as pessoas, o meio ambiente e os materiais, ele deverá ser descontaminado e limpo antes de ser enviado. O fabricante legal reserva-se o direito de recusar dispositivos ou acessórios contaminados. Os custos incorridos para a limpeza e desinfecção devem ser cobrados ao cliente..

19 ELIMINAÇÃO

Antes da eliminação, o dispositivo deve ser descontaminado e limpo para proteger as pessoas, o ambiente e a propriedade. Aquando da eliminação do dispositivo, deve cumprir as respetivas regras estatutárias. De acordo com a diretiva 2002/96/CE (REEE), os dispositivos fornecidos após 13 de agosto de 2005 não podem ser eliminados juntamente com o lixo doméstico. O dispositivo pertence ao grupo 8 (dispositivos médicos) e é categorizado no campo empresa a empresa. O ícone do caixote do lixo com uma cruz mostra que o dispositivo não pode ser eliminado juntamente com o lixo doméstico. As diretrizes de eliminação de resíduos dos diferentes países podem variar. Se necessário, contacte o seu fornecedor.



Aşağıdaki sembol tablosu sadece referans içindir. Geçerli semboller için ürün ambalajı etiketine bakın.

Sembol	Sembol Açıklaması
	Dikkat
	Elektronik kullanım talimatları
	Üretici
	BioHorizons products CE işareti taşıyor ve 93/42/EEC sayılı Tıbbi Cihaz Direktifi gereksinimlerine uygundur
	Referans/madde numarası
	Lot/parti numarası
	Yeniden kullanmayın
	Yeniden sterilize etmeyin.
	Son kullanma tarihi
	Gamma ırradyasyonu ile sterilize edilmiştir
	Üretim tarihi
	Dikkat: ABD Federal yasaları bu cihazların satışını, dağıtımını ve kullanımını bir dış hekimi veya doktor tarafından veya bunların siparişi üzerine yapılacak şekilde kısıtlar

Sembol	Sembol Açıklaması
	Ev konumu
	Ambalaj hasarlıysa kullanmayın
	Tıbbi cihaz
	Steril Değildir
	Kuru tut
	Kırılgan; dikkatli tutun
	Sıcaklık sınırları
	Bu şekilde yukarı
	Nem sınırları
	Uyarı; Biyolojik tehlike
	Önemli notlar
	Elektrikli ve elektronik cihazların ayrı toplanması.
	Avrupa Birliği Yetkili Temsilcisi

1 KULLANIM ENDİKASYONLARI

IntraSpin Sistemi hasta başında küçük bir kan numunesinden güvenli ve hızlı bir şekilde otolog trombosit bakımından zengin fibrin (L-PRF) hazırlamak üzere kullanım için amaçlanmıştır. L-PRF, kullanım özelliklerinin iyileştirilmesi için kemikli defekte uygulama öncesinde otogreft ve/veya allogreft ile karıştırılır. Kullanım Talimatlarındaki tüm bilgilere uyulması da amaçlanan kullanımın bir parçasıdır.

2 KONTRENDİKASYONLARI

IntraSpin santrifüj sadece cihazın kullanım amacında belirtilen amaç içindir. Cihazın başka herhangi bir şekilde kullanılması amaçlanmamıştır. IntraSpin santrifüjünün kullanımı, aşağıdaki klinik durumlardan bir veya daha fazlasının varlığında kontrendikedir: Alkol bağımlılığı veya psikiyatrik bozuklukları, kan diskrazileri, kontrolsüz diyabet, hipertiroidizm, oral enfeksiyonlar, maligniteler veya son zamanlarda miyokard enfarktüsü geçirmiş hastalar 12 ay. AIDS gibi bağışıklık sistemini tehlikeye atan sistemik hastalıkları olan hastalar, implant yerinin iyileşmesini tehlikeye atacak ilaçları olan hastalar, ağız hijyen prosedürlerine zayıf veya uyumsuz öyküsü olan hastalar.

Antikoagülan tedaviye katılan hastalar. Bu hastalar PRF'nin yararlarından hariç tutulmaz, bunun yerine bakım noktasının, ayırmanın kullanım için etkili olması için santrifüje ek zaman eklemesi gerekir.



3 GÜVENLİK NOTLARI

- Bu kılavuzda yer alan TÜM talimatlara uyulmadığı müddetçe üretici, hiçbir garanti talebini dikkate almayacaktır.
- Kullanım talimatları cihazın bir parçasıdır. Bunlar her zaman hazır bulundurulmalıdır. Cihaz farklı bir yere kurulmuşsa, kullanım talimatları cihazla birlikte verilmelidir..
- Santrifüj, iyi ve sağlam bir zemine kurulmalıdır.
- Santrifüjü kullanmadan önce rotorun sıkı bir şekilde yerleştirildiğini kontrol edin.
- Santrifüj, EN/IEC 61010-2-020 uyarınca çalıştırılırken santrifüjün çevresindeki 300 mm'lik güvenlik aralığı içinde insan ve tehlikeli madde veya nesne bulunmamalıdır.
- Korozyon izi bulunan veya mekanik hasar olduğu görülen veya kullanım süreleri dolmuş olan rotorlar, süspansiyonlar ve aksesuarlar daha fazla kullanılmamalıdır.
- Santrifüjleme hücresinde güvenlikle ilişkili hasar bulunan santrifüj artık çalıştırılmamalıdır.
- Sıcaklık kontrolü bulunmayan santrifüjlerde, oda sıcaklığı arttığında ve/veya cihaz sıklıkla kullanıldığında santrifüj hücresi ısınabilir. Bu nedenle sıcaklığa bağlı olarak numune malzemenin değişebileceği göz ardı edilemez.
- Santrifüjünüzün ilk çalıştırılmasından önce kullanım talimatlarını okumalı ve bunlara özen göstermelisiniz. Yalnızca kullanım talimatlarını okumuş ve anlamış olan personelin cihazı çalıştırmasına izin verilir.
- Kullanım talimatları ve kaza önlemeye yönelik yasal yönetmeliklerle beraber, güvenli ve profesyonel bir şekilde çalışmaya yönelik kabul edilmiş mesleki yönetmeliklere de uymanız gerekmektedir. Bu kullanım talimatları, cihazın kullanılacağı ülkenin ulusal mevzuatına bağlı olan kaza önleme ve çevre koruma ile ilgili diğer talimatlar ile bağlantılı olarak okunmalıdır.
- İş yerlerinde kullanıcı tarafından temin edilen santrifüjlerin kullanımı konusunda ülkelere özgü iş güvenliği gereksinimlerini karşılamak kullanıcının sorumluluğundadır.

- Bu santrifüj, çalıştırılması son derece güvenli olan en yeni teknoloji ürünüdür. Ancak eğitim almamış personel tarafından, yanlış bir şekilde veya tasarım amacı dışında kullanıldığında kullanan kişiye veya başkalarına karşı tehlikeye yol açabilir.
- Çalıştırıldığı sırada santrifüj hareket ettirilmemeli veya sarsılmamalıdır.
- Hata veya acil durdurma halinde rotor dönmeyi kesmeden önce rotora dokunmayın.
- Cihaz soğuk bir odadan sıcak bir odaya taşındığında yoğunlaşma olmaması, için santrifüj ya ana şebekeye bağlanmadan önce 3 saat boyunca sıcak odada ısıtılmalıdır ya da soğuk odada 30 dakika boyunca sıcak çalıştırılmalıdır.
- Maksimum devir dakika ile santrifüjleme yapılırken malzemelerin veya malzeme karışımlarının yoğunluğu 1,2 kg/dm³ değerini aşmamalıdır.
- Santrifüj ancak dengenin kabul sınırı içinde olduğu durumda çalıştırılabilir.
- Santrifüj, patlama tehlikesi bulunan alanlarda çalıştırılmaz.
- Santrifüj, şunlarla çalıştırılmaz: yanıcı veya patlayıcı malzemeler birbiriyle etkileşime geçerek çok enerji üreten malzemeler.
- Bu santrifüje yönelik hiçbir biyogüvenlik sistemi mevcut değildir..
- Santrifüj, rotorların, askıların ve aksesuarların mekanik bütünlüğünü kötü etkileyebilecek olan yüksek düzeyde aşındırıcı maddeler ile çalıştırılmamalıdır.
- Onarım çalışmaları yalnızca üretici tarafından yetkilendirilmiş personel tarafından gerçekleştirilmelidir.
- Hastalar için en yüksek klinik güvenlik seviyesini sağlamak üzere Intra-Lock ürünleri insan plazması ile biyo-uyumlu malzemelerden yapılmıştır.
- Bu ürün tüm pazarlarda satış için onaylanmamıştır ve bulunduğunuz pazarda mevcut olmayabilir. Ek bilgiler için lütfen yerel Intra-Lock temsilcinize danışın.

4 INTRASPIN SİSTEM BİLEŞENLERİ

BİLEŞEN	SİSTEM BAŞINA MİKTAR
IntraSpin Santrifüj dahil:	1
Güç kablosu	1
Sigorta	2
Altıgen El Anahtarı	1
Greiner Kan toplama tüpleri ve dengeleme tüpleri (tek kullanımlık).	150
Greiner Safety Kan Alma Seti + Tutucu, 21G (tek kullanımlık)	24
Lateks içermeyen turnike	1
Test tüpü rafı	1
Cerrahi Kavisli Makas	1
Cerrahi Doku Forsepsi	1
Yuvarlak Paslanmaz Çelik Kase	1
Dikdörtgen Paslanmaz Çelik Kase	1
Çift Biyomalzeme Taşıyıcı Spatula	1
Çift Biyomateryal Paketleyici	1
Xpression® Kutusu	1

Sadece IntraSpin santrifüj ile doğrudan kullanım için onaylanmış uyumlu bileşenler tavsiye edilir ve garanti edilir:

UYUMLU PARÇA #	AÇIKLAMA
455092	Tüp 9ml CAT Serum Pıhtı aktivatörü, kırmızı kapak
455001	Beyaz Kapak 9ml Z Katkısız kan alma tüpü
BHEXZ (E613)	IntraSpin Altıgen Anahtar, 110v ve 220v
BROTORZ (E3694)	IntraSpin Rotoru, 100v ve 220v
BPOWER110Z (E1673)	IntraSpin Güç Kablosu, 110v
BPOWER220Z (E1669)	IntraSpin Güç Kablosu, 220v
BTUBEHOLDZ (E872 x 1)	IntraSpin Tüp Tutucusunun Değiştirilmesi
BFUSE110Z (E997)	IntraSpin Sigorta 110v
BFUSE220Z (E891)	IntraSpin Sigorta 220v

5 KISA SANTRİFÜJ KURULUMU

Taşıma civatalarını santrifüjün altından çıkarın ve saklayın.

AC kablosunu takın ve elektrik prizine takın.

Cihazın arkasındaki basmalı anahtarı kullanarak güç santrifüjü açın.

Hız ve zamanı seçin: Hız = 2700 & Zaman = 12:00 min.

START (BAŞLAT) düğmesine basın.

Santrifüj kapağı her döngü sonunda otomatik olarak açılır.

İlk prosedürden sonra, ayarlar değiştirilmedikçe süre ve hız parametreleri santrifüj belleğinde kaydedilir.

6 KAN TOPLAMA TÜPLERİ VE KAN TOPLAMA SETİNE İLİŞKİN DİKKAT EDİLECEK HUSUSLAR VE TALİMATLAR

- Yabancı madde varsa tüpleri kullanmayın.
- Kan toplama tüplerinin tamamen dolması beklenmelidir.
- Tüm biyolojik numuneleri ve kan toplama “keskin aletlerini” (ör. iğneler ve kan toplama setleri) tesisinizin politikalarına ve prosedürlerine göre kullanın.
- İğneyi bükmeyin.
- Etkinleştirildikten sonra iğne emniyet mekanizmasını zorla serbest bırakmayın veya yeniden etkinleştirmeyin.
- HIV (AIDS), viral hepatit veya diğer bulaşıcı hastalıkların olası bulaşmasından dolayı biyolojik örneklerle (örn. Delinme yaralanması yoluyla) maruz kalma durumunda uygun tıbbi yardım alın.
- Tüm kan toplama “keskinliklerini” onaylı biyolojik tehlike kaplarında atın.
- Bir numunenin şırıngadan tüpe aktarılması tavsiye edilen bir işlem değildir.
- İntravenöz (IV) bir hattan kan alınırsa, kan alma tüplerini doldurmaya başlamadan önce hattın IV solüsyonundan temizlendiğinden emin olmak için kurumunuzun politikalarını ve prosedürlerini izleyin.
- Kan pıhtılaşma hızlandırıcı tüp yüzeyinde beyaz görünebilir, bu da tüplerin performansı üzerinde hiçbir etkisi yoktur. Tüpte başka bir renk değişikliği veya çökeltiler varsa, kullanılmamalıdır.
- Son kullanma tarihinden sonra tüpleri kullanmayın.
- Kan toplama tüplerini 4–25 °C’de (40–77 °F) depolayın.
- Kan toplama setini (iğne ve tutucu) 4–36 °C’de (40–97 °F) depolayın.

- Doğrudan güneş ışığına maruz kalmaktan kaçının. Önerilen maksimum saklama sıcaklığının aşılması tüp kalitesinin bozulmasına neden olabilir (yani vakum kaybı, renklendirme vb.).
- Geri akışı önlemek için, hastanın kolunu aşağı konumda tutun, tüpü kapağı yukarı gelecek şekilde tutun, kan tüpe akmaya başlar başlamaz turnikeyi serbest bırakın, damar içeriğinin damar delinmesi sırasında kapağa veya iğnenin ucuna temas etmesinden kaçının .
- Damar deliği uygulamadan önce aşağıdaki malzemelere kolayca erişilebildiğinden emin olun: gerekli tüm kan toplama tüpleri, örneklerin pozitif hasta tanımlaması için tanımlanmış etiketler, kan toplama iğneleri ve tutucuları, delinme bölgesini temizlemek için alkollü çubuk, temiz gazlı bez, turnike, yapışkan siva veya bandaj, onaylı biyolojik tehlike kabı. Kan yoluyla bulaşan patojenlere maruz kalmaya karşı koruma için uygun KKD (Kişisel Koruyucu Donanım) önerilir (örn. Eldivenler, laboratuvar önlüğü, gözlük vb.).

Damara Girme Tekniği ve kan numunesini toplama:

Toplama tüplerinde antikoagülan olmadığı için kan toplama mümkün olduğunca çabuk yapılmalıdır. Kan örneği hemen pıhtılaşmaya başlayacaktır. Damara girme sırasında ve maruz kalma tehlikesini en aza indirmek için kan alma tüplerini tutarken eldiven giyin. Kan alımından önce, kan tüpü kapaklarının üstünü seçtiğiniz dezenfektan mendillerle silin. İğnenin valf bölümü üzerindeki kapağı çıkarın. Venipunktur bölgesini uygun bir antiseptik ile hazırlayın. Temizlikten sonra venipunktur bölgesini palpe etmeyin. Hastanın kolunu aşağı konumda yerleştirin. İğne siperini çıkartın. Damar deliğini kol aşağı ve tüp kapağı en üstte olacak şekilde gerçekleştirin. Gerekliğinde iğneyi bant ile sabitleyin. Kan alma tüpünü tutucuya ve kan alma tüpünün kauçuk diyaframını delen iğne valfi üzerine itin. Yan duvar penetrasyonunu ve müteakip erken vakum kaybını önlemek için kapağa nüfuz ederken kan toplama tüplerini tutucuda ortalayın. Kan toplama tüpünde kan görüldüğünde turnikeyi çıkarın. Prosedür sırasında toplama tüpünü her zaman baş parmağınızla bastırarak yerinde tutun. Bu, tam bir vakum çekişini sağlayacaktır. Kan alma tüpü otomatik olarak dolar. Toplama tüpüne hiç kan akışı olmazsa veya yeterli bir numune alınmadan önce kan akışı kesilirse, tatmin edici bir toplama işlemini tamamlamak için aşağıdaki adımlar önerilir.:

- Kan toplama tüpünü ileri doğru iterek kapağa girmesini sağlayın.
- İğnenin ven içinde doğru konumda olduğunu onaylayın.
- Hâlâ kan akışı yoksa toplama tüpünü söküp uygun şekilde atın. Yeni bir toplama tüpü alın ve iterek tutucuya yerleştirin.
- İkinci toplama tüpü kan çekmiyorsa iğneyi ve toplama tüpünü söküp uygun şekilde atın. Prosedürü tekrarlayın.
- Kan alma tüpünün maksimum hacim dolum hattına ulaştığında, yavaşça tutucudan çıkarın. İkinci bir kan alma tüpüyle tekrarlayın.

Her toplama tüpünü tutucudan çıkardıktan hemen sonra yavaşça ters çevirin. Kan örneği ile doldurulmuş tüpleri sallamayın. Güçlü karıştırma köpürmeye veya hemolize neden olabilir. Serum tüplerinde yetersiz karıştırma veya gecikmeli karıştırma gecikmeli pıhtılaşmaya neden olabilir.

Kan numunesi toplama işlemi tamamlandıktan sonra iğneyi damardan çıkarın. Kilidi takmak için göbeğin her iki tarafına bastırarak iğnenin emniyet mekanizmasını (emniyet kılıfı) etkinleştirin. Bir tık sesi duyulana dek emniyet mekanizmasını geriye doğru kaydırın. İğne batması nedeniyle yaralanma ve kan maruziyeti riskini artırdığından iğneyi tekrar kapatmayın. Kullanılmış iğneyi, uygun bir biyolojik tehlikeli atık kabı kullanarak

atın. Kanama durana kadar kuru steril bir çubukla ponksiyon bölgesine basınç uygulayın. İstenirse, pıhtılaşma meydana geldiğinde bir bandaj uygulayın. Doldurulmuş toplama tüplerinin dik konumda tutulması tavsiye edilir. İkinci tüp de dolduğunda çıkarın, birinci ve ikinci tüpü rotor dengesini sağlamak için santrifüjde karşıt konumlara koyun IntraSpin® santrifüjün kapağını kapatın ve 12 DAKİKA boyunca dönmesi için "START" (BAŞLAT) düğmesine basın.

İki tüpten fazla kan gerekirse, lütfen bu alternatif prosedürü takip edin: İlk iki kan tüpü toplanıp nazikçe ters çevrildikten sonra, bunları derhal IntraSpin santrifüje, santrifüj dengesini sağlamak için birbirlerine karşılıklı olarak yerleştirin. Kapağı kapatın ve BAŞLAT düğmesine basın ve kalan kan tüplerini alırken santrifüjün çalışmasına izin verin. STOP düğmesine basın ve santrifüjün tamamen durmasını bekleyin. Kapak açılır; dengeyi sağlamak için kalan tüpleri hemen santrifüjün tersine yerleştirin ve önerilen protokolü sıfırlamak ve tamamlamak için BAŞLAT düğmesine basın.

Santrifüj rotorunu dengelemek için tüpleri daima çiftler halinde ve birbirlerine karşılık gelecek şekilde yerleştirin. START (BAŞLAT) düğmesine basılmadan önce tüpler daima dengelenmiş olmalıdır aksi halde santrifüj ciddi anlamda hasar görebilir, uygun olmayan koagülasyon ve/veya ayrılma meydana gelebilir. Tüpler uygun şekilde dengelenmezse, santrifüjleme sırasında çok fazla titreşim olur ve zayıf bir L-PRF fibrin pıhtısı oluşur.

Santrifüjleyeceğiniz kan numunelerinin sayısı tek sayıysa rotorda çifti olmayan tüpün karşısına, belirtilen dolun çizgisine kadar su ile doldurulmuş beyaz kapaklı bir dengeleme tüpü (ör. 455001) yerleştirin. Santrifüj bu şekilde uygun bir şekilde dengelenebilir.

Santrifüj işlemine kan örnekleri toplanır toplanmaz başlayın. Gecikmeler kan ayırma prosedürünü etkiler ve zayıf bir L-PRF fibrin pıhtısı ile sonuçlanır.

7 L-PRF HAZIRLAMA

Santrifüj işleminde sonra üç segment görülür haldedir:

1. Üst Segment = trombosit açısından fakir plazma (PPP).
2. Orta Segment = fibrin pıhtı: L-PRF.
3. Alt Segment = alyuvar pıhtısı.

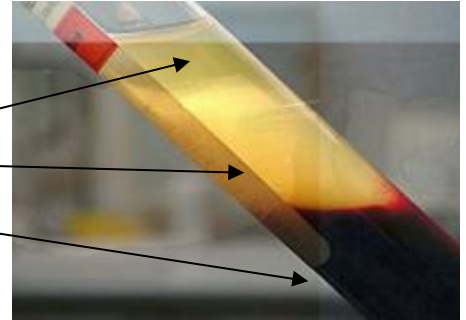

L-PRF fibrin membranları veya tapaları nispeten hızlı bir şekilde hazırlanmalıdır: santrifüj işleminden 0-15 dakika sonra aksi halde pıhtı tutulan serumu serbest bırakarak hacmen küçülecektir. Santrifüj işleminden sonra Her tüpün kauçuk başlığını çıkarın. Using the Surgical Tissue Forceps remove the L-PRF clot from the tube. Kırmızı kan hücresi pıhtısını L-PRF® fibrin pıhtısından Çift Biyomateryal Taşıyıcı Spatula'yı kullanarak nazikçe sıyırın, böylece L-PRF pıhtısına sadece minimum, artık miktarda kırmızı kan hücresi eklenir. Fibrin pıhtısını Xpression Delikli Tepsiyeye yerleştirin.

8 FIBRİN MATRIX HAZIRLIK

Protokol 1 L-PRF Membran

Her fibrin pıhtısını Xpression Delikli Tepsi üzerine yerleştirin. Tüm fibrin pıhtıları yerleştirildikten sonra, Xpression Sıkıştırma Plakasını ve Xpression Ağırlıklı Kapağı pıhtılar üzerinde herhangi bir baskı uygulamadan fibrin pıhtılarının üzerine yerleştirin.

Eksüda tepsinin dibine süzülürken kapağın ağırlığının fibrin pıhtısına yavaşça basmasına izin verin. Ağırlıklı kapağa baskı uygulamayın. Ağırlıklı kapak üzerindeki yerçekimi kuvveti pıhtıyı hafifçe sıkıştırarak ve fibrin ağına zarar vermeden L-PRF pıhtısından serumu eksprese edecektir.

Herhangi bir fibrin zararını çıkarmadan ve kullanmadan önce en az 5 dakika bekleyin. Gerçek kullanım zamanına kadar hiçbir fibrin zararını çıkarmayın. Fibrin membran Xpression Kutusu'nda 3 saate kadar bir süre kalabilir.

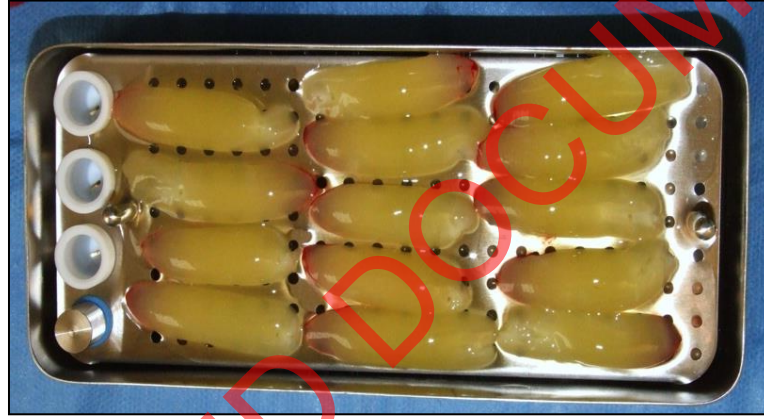

Protokol 2 L-PRF Fiş

Beyaz tapa imalat silindirinine içine bir fibrin pıhtısı yerleştirin. Pistonu kullanarak beyaz L-PRF tapa imalat silindirinine içindeki pıhtıya yavaşça bastırın. Pistonun üst kenarı beyaz L-PRF tapa imalat silindirinine üst kenarı ile aynı hizaya gelene kadar bastırmaya devam edin. Bu teknikte, ekstraksiyon soketi için kalın, yuvarlak bir fibrin tapası oluşturulabilir. Tek bir diş için bir L-PRF tapası yeterli olabilir. Ön azı dişleri için iki L-PRF tapaya ihtiyaç duyabilir ve çıkarma soketinin büyüklüğüne ve oluşturulan fibrin pıhtısının büyüklüğüne bağlı olarak azı dişleri için üç L-PRF tapa gerekebilir.

L-PRF® çalışma özellikleri, tercih ettiğiniz biyomalzeme ile birlikte kullanım için mükemmel bir madde sağlar. Aşağıdaki karıştırma protokollerinden biri kullanılarak biyomalzeme fibrin matrisi içine alınarak kullanım ve biyolojik kapasitesi artırılır.

Protokol 3- Biyomalzeme/L-PRF Karışımı

Biyomalzeme aleti ile istenen şekle ve kalınlığa nazikçe getirilebilen 'macun kıvamında' bir karışım elde etmek için aşağıdaki protokolü kullanın: L-PRF fibrin membran yavaşça cerrahi kavisli makas ile steril bir tabak içinde küçük parçalar halinde kesin. İstlenen kemik grefti malzemesini ekleyin. L-PRF® ile kemik

grefti malzemesini iyice karıştırın. Bu karışım, Çift Biyomateryal Taşıyıcı Spatula kullanılarak kusurlara yerleştirilebilir.



Protokol 4- iyomalzeme/L-PRF Matrisi Karışımı

Önceden belirlenmiş bir miktar kemik grefti malzemesini steril bir kaseye veya tepsiye koyun. İfade edilen L-PRF membran (lar) ı veya L-PRF membran parçalarını, greft materyali ile L-PRF membranının tüm yüzey alanını kaplayan greft materyaline batırın. Alternatif olarak, greft malzemesi L-PRF® membran üzerine, tüm yüzey alanı greft malzemesi ile kaplanacak şekilde de serpilebilir. Not: Daha ıslak bir L-PRF membranı, bir kurutucu L-PRF membranından biraz daha fazla greft malzemesi tutabilir. Greft malzemesi L-PRF® yüzeyine yapışmalıdır ancak istenirse greft malzemesini nazikçe L-PRF® membran içine bastırın. Cerrahi Doku Forsepsi bu karışımı defekt içine yerleştirmek için kullanılabilir.



Protokol 5- Biyomalzeme Hidrasyonu

Steril bir kaseye veya tepsiye istenen miktarda kemik grefti materyali ekleyin. Greft materyalini nemlendirmek için Xpression Toplama Tepsisinin alt kısmından eksüdayı kullanın. Eksüda ve kemik grefti malzemesini iyice karıştırın. Bu karışım, Çift Biyomateryal Taşıyıcı Spatula kullanılarak kusurlara yerleştirilebilir.

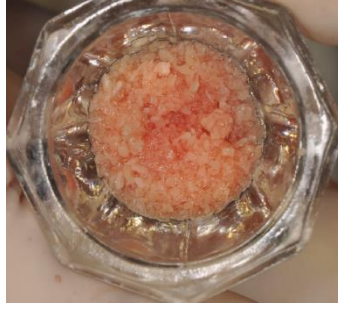

9 DOKU REJENERASYON KİTİ TEMİZLİK VE STERİLİZASYON

Xpression® Kutusu, fibrin membranların tutarlı bir kalınlıkta kolaylıkla üretimini sağlar. Eksüda, Xpression Delikli Tepsinin altındaki Xpression Toplama Tepsisinden toplanabilir. Xpression Kutusu, L-PRF tapa imalat silindirleri ve çıkarma sonrası soketlere kolayca uyan L-PRF tapaları üretmek için bir piston içerir.



Xpression Ağırlıklı Kapak

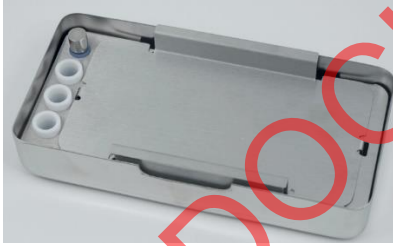

Xpression Sıkıştırma Plakası

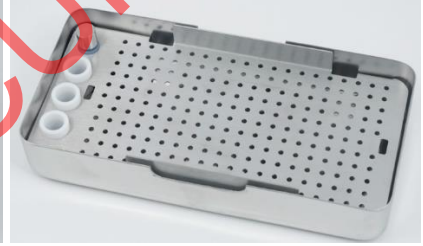

Xpression Toplama Tepsisindeki
Xpression Delikli Tepsi

Xpression Kutusu ve yardımcı cihazlar steril olarak verilmez. İlk sterilizasyondan önce nakliye malzemelerini çıkarın ve atın. Her kullanımdan önce Xpression Kutusu'nu ve yardımcı aletleri temizleyin ve sterilize edin.

Kalıntıların kapsüllenmesini, malzemede renk bozulmasını ve / veya bileşenlerin yetersiz kurumasını önlemek için her temizleme ve sterilizasyon döngüsünden önce Xpression kutusunu sökün. L-PRF tapa imalat silindirleri ve piston rondelası, temizleme ve sterilizasyon için Xpression Delikli Tepsisinden çıkarılmak üzere tasarlanmamıştır.

Temizlik: (1) Yumuşak kıl fırça ve Hu-Friedy'nin Enzymax® veya eşdeğeri gibi geniş spektrumlu bir temizleme veya dezenfekte edici ajan kullanarak Xpression kutusu bileşenlerinden ve yardımcı cihazlardan görünür kalıntıları giderin. İyi durulayın. (2) Xpression kutusu bileşenlerini ve yardımcı aletleri aynı çözeltinin uygun büyüklükte bir kabına yerleştirin ve 10 dakika sonikasyon uygulayın. İyi durulayın. (3) Sabun kalıntılarını ve mineralleri çıkarmak için Xpression kutu bileşenlerini ve yardımcı aletleri izopropil alkolle durulayın. (4) Xpression kutusu bileşenlerini ve yardımcı aletleri havsız bir havluyla kurulayın ve tamamen kurulayın. Kullanım talimatları için kullanılan temizlik maddesinin etiketine bakın.

Sterilizasyon: (1) Yeniden monte edilmiş Xpression kutusunu ve yardımcı aletleri FDA onaylı sterilizasyon torbasına veya sargısına yerleştirin. (2) Aşağıdaki kalifiye sterilizasyon döngülerinden birini uygulayın:

Sterilizasyon Yöntemi	Sıcaklık	Maruziyet süresi	Minimum Kuruma Süresi
Vakum Öncesi Buhar (ANSI/AAMI ST79)	132°C (270°F)	4 dakika	20-30 dakika
Vakum Öncesi Buhar (UK DoH Health Technical Memorandum 01-01)	134°C (273°F)	3 dakika	20-30 dakika

Dikkat! Yanlış temizlik yetersiz sterilizasyona neden olabilir. Otoklavlama sırasında Xpression Box bileşenlerinin ve yardımcı aletlerin tamamen kurumaması nem bırakabilir ve renk bozulmasına ve oksidasyona neden olabilir. Hidrojen peroksit veya diğer oksitleyici ajanların kullanımı, Xpression Box bileşenlerinin ve yardımcı aletlerin yüzeyine zarar verecektir. Ünitenin uygun çalışma düzeninde kalmasını sağlamak için otoklav ekipmanının periyodik testi, temizlenmesi ve kalibrasyonu önerilir.

10 SANTRİFÜJ TEMİZLEME VE BAKIM

Cihaz kirlenebilir. Temizlik işlemi öncesinde fişi çekin. Santrifüj, rotor ve aksesuarlar, durulama makinelerinde temizlenmemelidir. Yalnızca elle temizlenmeli ve sıvılarla dezenfekte edilmelidir. Su sıcaklığı, 20 – 25°C arasında olmalıdır. Sadece pH'ı 5-8 arasında olan ve kostik alkaliler, peroksitler, klor bileşikler, asitler ve alkalın çözeltileri içermeyen deterjanlar / dezenfektanlar kullanılabilir. Temizlik maddeleri veya dezenfektanlar ile korozyon oluşumunu önlemek için, üreticinin temizlik maddeleri veya dezenfektanlara yönelik uygulama kılavuzuna kesinlikle uyulmalıdır.

Santrifüj muhafazasını ve santrifüj haznesini düzenli olarak temizleyin, gerektiğinde nemli bez, sabun veya hafif deterjan kullanın kirleri yapıştırmak korozyonu önlemek için. Uygun deterjanların içerikleri arasında sabun, anyonik sürfaktanlar ve noniyonik sürfaktanlar bulunmaktadır. Deterjan kullandıktan sonra fazla deterjanı nemli bir bez ile silin. Temizliğin ardından yüzey hemen kurutulmalıdır. Kondensat oluşumu halinde santrifüj haznesini emici bir bez ile kurulayın. Her temizlik işleminden sonra santrifüj haznesinin kauçuk contasını talk pudrası veya kauçuk bakım ürünü ile hafifçe ovalayın. Santrifüjleme haznesi hasar açısından kontrol edilecektir. Güvenlikle ilgili bir hasar tespit edilmesi halinde santrifüj daha fazla kullanılmamalıdır. Bu durumda Müşteri Hizmetleri'ne bilgi verin.

Yüzey dezenfeksiyonu için, Bulaşıcı malzemelerin santrifüj haznesine girmesi halinde hemen dezenfekte edilmelidir. Uygun dezenfektanların içerikleri arasında etanol, n-propanol, etil heksanol, anyonik yüzey aktif cisimleri ve korozyon inhibitörleri bulunur. Dezenfektan kullandıktan sonra fazla dezenfektanı nemli bir bez ile silin. Dezenfeksiyonun ardından yüzey hemen kurutulmalıdır.

Radyoaktif kirlenmelerin uzaklaştırılması için, kullanılacak maddenin, radyoaktif kirlenmeleri gidermeye yönelik bir madde olduğu özel olarak etiketlenmiş olması gereklidir. Radyoaktif kirlenmeleri gidermeye yönelik uygun maddelerin içerikleri arasında anyonik yüzey aktif cisimleri, iyonik olmayan yüzey aktif cisimleri, polihidre edilmiş etanol bulunur. Radyoaktif kirlenmelerin giderilmesinden sonra kalan temizlik maddesini nemli bir bez ile silin. Yüzey, radyoaktif kirlenmelerin giderilmesinin hemen ardından kurutulmalıdır.

11 ROTOR VE AKSESUARLAR TEMİZLİK VE BAKIM

Korozyonu ve malzemelerde deęişiklik olmasını önlemek için rotor ve aksesuarlar, nemli bir bez, sabun veya hafifi temizlik maddesiyle düzenli olarak temilenmelidir. En az haftada bir defa temizlik yapılması önerilir. Kirletici maddeler hemen temizlenmelidir.

Uygun deterjanların içerikleri arasında sabun, anyonik sürfaktanlar ve noniyonik sürfaktanlar bulunmaktadır. Deterjan kullandıktan sonra fazla deterjanı suyla durulayın (yalnızca santrifüjün dış kısmı) veya nemli bir bezle silin. Rotor ve aksesuarlar, temizlik işleminin ardından hemen kurutulmalıdır. Rotor ve aksesuarları haftada bir aşınma veya korozyona karşı kontrol edin. Aşınma veya korozyon belirtileri görünen rotor ve aksesuarlar daha fazla kullanılmamalıdır. Rotorun sağlam bir şekilde oturduğunu haftada bir kontrol edin. Rotor veya aksesuarlara bulaşıcı madde girerse uygun bir şekilde dezenfekte edilmelidir.

Uygun dezenfektanların bileşenleri arasında etanol, n-propanol, etil heksanol, anyonik yüzey aktif cisimleri ve korozyon inhibitörleri bulunur. Dezenfektan kullandıktan sonra fazla dezenfektanı suyla durulayın (yalnızca santrifüjün dış kısmı) veya nemli bir bezle silin. Rotor ve aksesuarlar, dezenfeksiyon işleminin ardından hemen kurutulmalıdır.

Radyoaktif kirleticilerin uzaklaştırılması için, Kullanılacak maddenin, radyoaktif kirleticileri gidermeye yönelik bir madde olduğu özel olarak etiketlenmiş olması gereklidir. Radyoaktif kirleticileri gidermeye yönelik uygun maddelerin içerikleri arasında anyonik yüzey aktif cisimleri, iyonik olmayan yüzey aktif cisimleri ve polihidre edilmiş etanol bulunur. Radyoaktif kirleticiler giderildikten sonra fazla temizlik maddesini suyla durulayın (yalnızca santrifüjün dış kısmı) veya nemli bir bezle silin. Rotor ve aksesuarlar, radyoaktif kirleticilerin giderilmesinin hemen ardından kurutulmalıdır.

Rotor, 20 dakika boyunca 121oC / 250oF'de otoklavlanabilir ve uygun şekilde kurutulabilir. 10 otoklavlama döngüsünden sonra rotor, güvenlik sebepleriyle deęiştirilmelidir. Otoklavlama plastiklerin yaşlanma sürecini hızlandırır ve renk deęişikliğine neden olabilir. Otoklavlamadan sonra, tekrar kullanmadan önce rotorun ortam sıcaklığına soğumasını bekleyin. Sterillik derecesi konusunda bir beyanda bulunulamaz.

Rotorun kullanım süresi, hangisi önce gelirse, 50.000 çalışma döngüsü (santrifüjleme çalışması) veya 5 yıl ile sınırlıdır. Maksimum izin verilen işlem döngüsü sayısı rotor üzerinde görülebilir. Güvenlik sebebiyle rotor, maksimum izin verilen işlem döngüsü (üzerinde yazılıdır) sayısına ulaşıldıktan sonra kullanılmamalıdır. Cihaz, çalışma döngülerini (santrifügasyon işlemi) sayan bir döngü sayacı ile donatılmıştır.

Kan tütünün kırılması durumunda, tüm kırık parçalar ve kan tamamen çıkarılmalıdır. Santrifüj, belirtildiği gibi iyice temizlenecek ve kauçuk ekler ve rotorun plastik kovanları deęiştirilecektir.

12 SANTRİFÜJ TEKNİK ÖZELLİKLERİ

Model türü	IS220Z	IS110Z
Şebeke gerilimi (\pm %10)	200 - 240 V 1~	100 - 127 V 1~
Şebeke frekansı	50 - 60 Hz-	50 - 60 Hz
Bağlanmış yük	100 VA	100 VA
Akım tüketimi	0.5 A	1.0 A
kapasite	8 x 10 ml	
İzin verilen maksimum yoğunluk	1.2 kg/dm ³	
Azami hız (Dev/dk)	6,000	
Kuvvet (RCF)	3,461	
Kinetik enerji	750 Nm	
Kurulum alanı	Yalnızca kapalı alan	
Yükseklik	Deniz seviyesinden en fazla 2000 m	
Çalışma için ortam sıcaklığı	5°C - 40°C	
Çalışma için Bağıl Nem	31°C'ye varan sıcaklıklar için maksimum bağıl nem %80, 40°C'de doğrusal azalan %50 bağıl nem	
Aşırı voltaj kategorisi	II	
Kirlilik derecesi	2	
Cihaz koruma sınıfı	I	
	Patlama tehlikesi bulunan alanlarda kullanıma uygun değildir.	
Yayılan interferans, İnterferans dayanıklılığı	EN / IEC 61326-1, Sınıf B	FCC Sınıf B
Gürültü düzeyi (rotora bağlıdır)	\leq 50 dB(A)	
Santrifüj genişliği	261 mm	
Santrifüj Derinliği	353 mm	
Santrifüj Yüksekliği	228 mm	
Santrifüj Ağırlığı	yaklaşık 9 kg	

13 SANTRİFÜJ KULLANMA TALİMATLARI

2 vida (a) ve 2 ara (b) parçadan oluşan nakliye emniyet cihazının çıkarılması zorunludur. Cihazın taşınmasından önce tekrar takılması gerekeceği için taşıma emniyet aygıtını koruyun. Cihaz ancak taşıma emniyeti aygıtı takılı olarak taşınabilir. Taşıma sırasında cihaza hasar gelmesini önlemek için, motor yerine sabitlenmiştir. Cihaz çalıştırılmadan önce bu taşıma emniyeti aygıtının çıkarılması gereklidir.

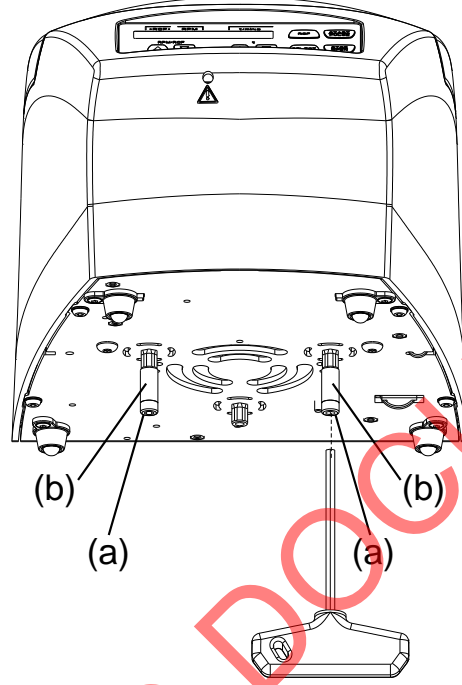

13.1 İLK ÇALIŞTIRMA

- Nakliye emniyet cihazını santrifüjün alt tarafından çıkarın.
- Santrifüjü uygun bir yere sabit ve düz hizalı olacak şekilde yerleştirin. Santrifüj, çalıştırılırken hiç kimse, hiçbir tehlikeli madde veya nesne santrifüjün çevresindeki 300 mm'lik güvenlik aralığı içinde bulunmamalıdır.
- Havalandırma boşlukları, kapalı olmamalıdır. Santrifüjün havalandırma yuva ve boşluklarından 300 mm'lik bir mesafe korunmalıdır.
- Şebeke voltajının, tip plakasında belirtilen değer ile uyumlu olup olmadığını kontrol edin.
- Santrifüjü, güç kablosu ile standart şebeke prizine takın.
- Ana şalteri açın.
- Panelde şu ekranlar görünür: santrifüj model tipi, yazılım sürümü ve son kullanılan santrifüj verileri.
- Kapak kapalı ise "Open the Lid (Kapağı aç)" mesajı gösterilir. Bu durumda santrifügasyon verisini görüntülemek için kapağı açın.

13.2 SANTRİFÜJ KAPAĞININ AÇILMASI VE KAPANMASI

Kapak yalnızca santrifüj ana düğmesi açık ve rotor hareketsiz halde iken açılabilir. Santrifüjleme çalışmasından sonra döngü sayacı aktif ise kapak açılırken kısa bir süre için geri kalan döngü sayısı (santrifüj çalışması) gösterilir.



Örnek:



Kapağı açmak için aşağıdaki tuşa basın . Kapak kilidi, motor tarafından açılır.  kapağın kilitsiz olduğunu gösterir.

. Kapak kilidi, motor tarafından açılır.  kapağın kilitsiz olduğunu gösterir.



Örnek:

Kapak ve muhafaza arasına parmaklarınızı uzatmayın. Kapağı sert bir şekilde kapatmayın.

Kapağı kapatmak için kapağın ön kenarına hafifçe bastırın.  kilitli kapağı gösterir.



Örnek:

13.3 ACİL KİLİT AÇMA

Elektrik kesintisi durumunda kapak, motor ile açılmaz. Acil kilit açma, elle yapılmalıdır. Acil bir durumda kilidi açmak için, Ana şalteri kapatın (şalter ayarı "0"). Rotorun durduğundan emin olmak için kapak üzerindeki pencereden bakın. Kapağı yalnızca rotor durur halde iken açın. Alyan anahtarını deliğe (A) sokun ve kapak açılana kadar dikkatli bir şekilde saat yönünün tersine (sola) çevirin. DİKKAT! Altıgen Allen anahtarının saat yönünde (sağa) çevrilmesi kilitleme sistemine zarar verebilir. Alyan anahtarını delikten çıkarın.

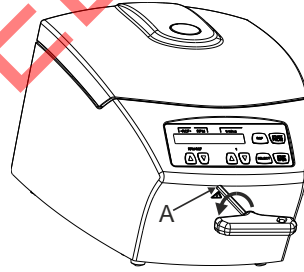

13.4 ROTORUN TAKILMASI VE ÇIKARILMASI

Rotoru çıkarmak için, alyan anahtarı (ürünle birlikte verilir) ile bağlama somununu saat yönünün tersine çevirerek sökün ve kaldırma basınç noktasına doğru çevirin. Kaldırma basınç noktasını geçtikten sonra rotor, motor şaftının yuvasından çıkar. Rotor, motor şaftından kaldırılabilir duruma gelene kadar bağlama somununu çevirin. Rotoru, motor şaftından kaldırın.

Rotoru takmak için, motor şaftını (A) ve rotor deliğini temizleyin ve ardından motor şaftına ince bir gres katmanı sürün. Motor şaftı ve rotor arasındaki kir parçacıkları, rotorun kusursuz bir şekilde oturmasını engeller ve düzgün bir şekilde çalışmamasına neden olur. Rotoru, dikey olarak motor şaftına yerleştirin. Rotoru yerleştirirken, rotorun üzerindeki işaret çizgileri, motor şaftının her iki yüzeyine (C) paralel olmalıdır. Rotorun bağlama somununu alyan anahtarı ile (teslimat kapsamındadır) saat yönüne çevirerek sıkın. Sağlam bir şekilde oturduğundan emin olmak için rotoru kontrol edin.

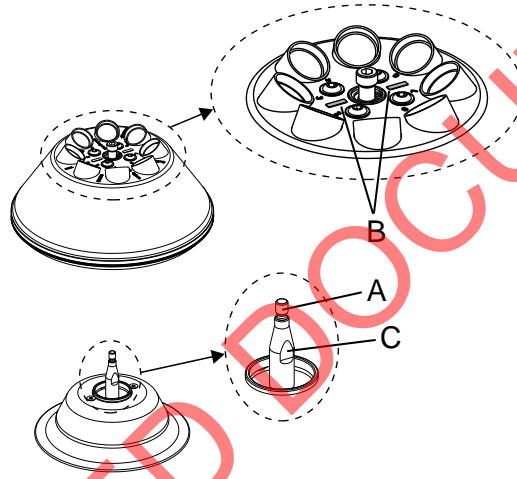

Rotorlar, simetrik olarak yüklenmelidir. Kan tüpleri tüm rotor pozisyonlarına eşit olarak dağıtılmalıdır.



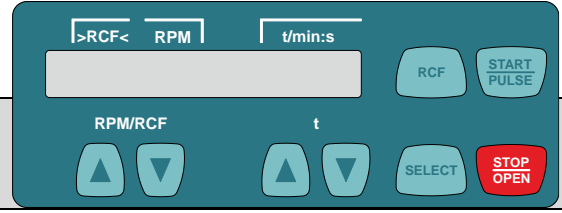

Kan tüpleri sadece santrifüjün dışında doldurulabilir. Kan tüpleri için maksimum dolm miktarı tüplerin kendisinde belirtilmiştir ve rotorda listelenen maksimum ağırlığı aşmamalıdır. Santrifüj hücreleri, yalnızca santrifüj çalışırken içlerinden sıvı atılmayacak kadar doldurulabilir. Rotor yüklenirken, rotora veya santrifüj haznesine sıvı girmemelidir. Santrifüj konteyneri içindeki ağırlık farklılıklarını olabildiğince marjinal tutmak için kan tüplerinde tutarlı bir dolm seviyesi önerilir.

13.5 EKRAN ELEMANLARI AÇIKLAMASI



sembol / Panel Anahtarı	Açıklama
	Kapak kilidi açık.
	Kapak kilitli.
	Dönüş ekranı. Dönüş ekranı yanar, rotor çalıştığı sürece, rotor dönerken.
	Hızı doğrudan girin. Tuş basılı tutulursa değer, artan hızla değişir.
	Çalışma süresini doğrudan girin. 1 saniye ile bir dakika arası adımlarda ve 1 dakikadan başlayan 1 dakikalık adımlarla ayarlanabilir. Santrifüjleme parametrelerini girin. Tuş basılı tutulursa değer, artan hızla değişir.
	Tek tek parametreleri etkinleştirmek için. Tuşa her basıldığında bir sonraki parametre etkinleştirilir. Tuşu 8 saniye basılı tutun çağırarak "MACHINE MENU" (MAKİNE MENÜSÜ). "Machine Menu" ekranında, "-> Info (Bilgi)", "-> Settings (Ayarlar)" ve "->Time & Cycles (Saat ve Döngüler)" menülerini seçin. Menülerde ileri devam edin.
	Hız göstergesi (RPM) ile bağıl merkezkaç kuvveti göstergesi (>RCF<) arasında geçiş yapmak için. RCF değerleri oklar arasında görüntülenir >>.
	Santrifügasyon çalışmasını başlatın. Kısa süreli santrifügasyon. Tuşa basılı tutulduğu sürece santrifügasyon çalışır. Menüleri seçmek için "->Info", "->Settings" ve "->Time & Cycles".
	Santrifügasyon çalışmasını bitirin. Rotor, önceden seçilmiş durma aşaması ile çalışmayı durdurur. Tuşa iki defa basılması, Acil Durdurmayı tetikler. Kapak kilidini açın.
t/min (s/dk)	Çalışma süresi. 1 dakikalık adımlarla 1 - 99 dk arasında ayarlanabilir.
t/sec (s/sn)	Çalışma süresi. 1 saniyelik adımlarla 1 - 59 sn arasında ayarlanabilir. Sürekli çalışma "--:--". t/min and t/sec parametrelerini sıfıra ayarlayın.
Dev/dk	Hız. 200 dev/dk ile rotorun maksimum hızı arasındaki bir sayısal değer ayarlanabilir. 10'luk adımlarla ayarlanabilir.
>RCF<	Bağıl santrifüj kuvveti. 200 dev/dk ile maksimum rotor hızı arasında bir sayısal bir değer ayarlanabilir. 1'lik adımlarla ayarlanabilir. Bağıl santrifüj kuvveti (RCF) ancak RCF ekranı (>RCF<) etkin ise girilebilir. Bağıl santrifüj kuvveti (RCF), santrifüjleme yarıçapına (RAD) bağlıdır. RCF girildikten sonra doğru santrifüjleme yarıçapının ayarlandığından emin olmak için kontrol edin.
RAD/mm	Santrifüjleme yarıçapı. 1 mm'lik adımlarla 10 mm ila 250 mm arasında ayarlanabilir. Santrifüjleme yarıçapı ancak RCF ekranı (>RCF<) etkin ise girilebilir.
~_DEC	Durma aşaması. fast (hızlı) = kısa durma süresi, slow (yavaş) = uzun durma süresi.

13.6 SANTRİFÜGASYON PARAMETRELERİNİN DOĞRUDAN GİRİLMESİ

Hız (RPM), bağıl santrifüj kuvveti (RCF), santrifüjleme yarıçapı (RAD) ve çalışma süresi, önceden   tuşuna basarak  tuşları ile doğrudan girilebilir. Santrifüjleme parametreleri yalnızca, santrifüjasyon çalışması başladıktan sonra kaydedilir.

Hız İçin (RPM):



Gerektiğinde RPM ekranını (RPM) etkinleştirmek için tuşa basın.



Tuşlarla istenen değeri ayarlayın.

Örnek:



Bağıl santrifüj kuvveti (RCF) ve santrifüjleme yarıçapı (RAD):



Gerektiğinde RCF ekranını (>RCF<) etkinleştirmek için tuşa basın.



Tuşlarla istenen RCF değerini ayarlayın.

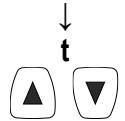

Gerektiğinde tuşlarla istenen santrifüjleme yarıçapını ayarlayın.

Örnek:



Çalışma süresi:

1 dakikaya kadar çalışma süresi 1 saniyelik adımlarla ve 1 dakikadan itibaren de yalnızca 1 dakikalık adımlarla ayarlanabilir. Sürekli çalışmaya ayarlamak için **t/min** (s/dk) ve **t/sec** (s/sn) parametrelerinin sıfıra getirilmesi gereklidir. Süre ekranında (t/min:s), "--:--" görünür.

Örnek:

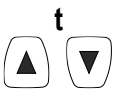

Tuşlarla istenen değeri ayarlayın.

Örnek:





13.7 "SELECT (SEÇ)" TUŞU İLE SANTRİFÜGASYON PARAMETRELERİNİ GİRİN.

Çalışma süresi dakika ve saniye olarak ayarlanabilir (**t/min** (s/dk) ve **t/sec** (s/sn) parametreleri). Sürekli çalışmaya ayarlamak için **t/min** (s/dk) ve **t/sec** (s/sn) parametrelerinin sıfıra getirilmesi gereklidir. Süre ekranında (t/min:s), "--:--" görünür.

Örnek: 

Bağlı santrifüj ivmelenmesi (RCF), santrifüleme yarıçapına (RAD) bağlıdır. RCF'in girilmesi sırasında ayarlanmış santrifüleme yarıçapı gösterilir. Parametre girişi sırasında veya seçimden sonra 8 saniye boyunca hiçbir tuşa basılmaz ise ekranda önceki değerler gösterilir. Ardından parametreler tekrar girilmelidir.

 düğmesine basıldığında ayarlar kaydedilecektir. Birden fazla parametre girilirse, son parametre ayarlandıktan sonra  tuşuna basılmalıdır.  tuşuna basılarak parametre girişi istenilen anda iptal edilebilir. Bu durumda ayarlar kaydedilmez.

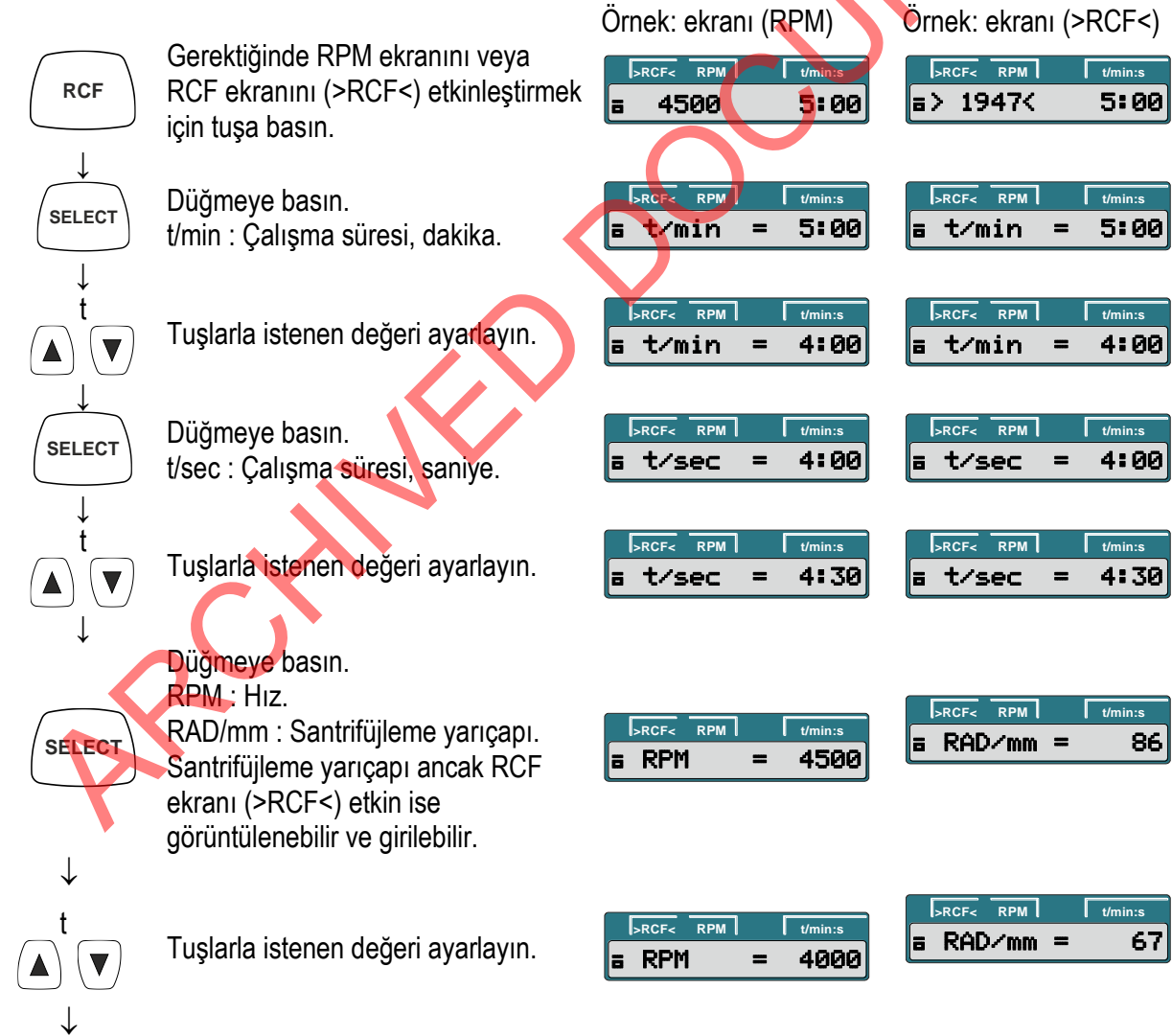



Düğmeye basın.
R : Santrifüjleme yarıçapı.
RCF : Bağlı santrifüj kuvveti

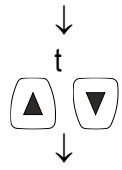

Tuşlarla istenen değeri ayarlayın.



Düğmeye basın.
~DEC: Durma aşaması.
fast (hızlı) : kısa durma süresi.
slow (yavaş) : uzun durma süresi.

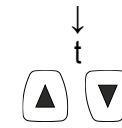

Tuşlarla istenen değeri ayarlayın.



Ayarları kaydetmek için düğmeye basın.



13.8 KONTROL PANELİ EKRANI

Her santrifügasyon çalışmasından sonra kapak kilitliken kalan çalışma döngüsü sayısı (santrifügasyon çalışmaları) kısa bir süre için görüntülenir.

Örnek:



Rotor yükünde izin verilebilir ağırlık farkı aşılmış ise, santrifügasyon çalışma başlatma sırasında kesilir ve "IMBALANCE" görüntülenir.

Örnek:



Santrifügasyon çalışması sırasında  tuşuna basılarak istendiği zaman kesilebilir. Santrifügasyon çalışması sırasında santrifügasyon parametreleri seçilebilir ve değiştirilebilir. Ancak değiştirilen değerler yalnızca

devam eden santrifügasyon çalışmasına uygulanır ve kaydedilmez.  tuşu ile istediğini zaman RPM ekranı (RPM) ve RCF ekranı (>RCF<) arasında geçiş yapabilirsiniz. RCF ekranı (>RCF<) ile çalışılıyor ise, santrifüjleme yarıçapı girilmelidir. Bunun ardından santrifüjün çalışması ancak kapağın açılmasından sonra olabilir. Çalışma hataları ve arızalar gösterilecektir.

Örnek:



13.9 ÖN AYARLI SÜRE İLE SANTRİFÜGASYON

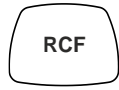

Gerektiğinde RPM ekranını (RPM) veya RCF ekranını (>RCF<) etkinleştirmek için tuşa basın.



İstenen santrifügasyon parametrelerini girin



Santrifügasyon çalışmasını başlatmak için tuşa basın. Santrifügasyon çalışması sırasında rotor hızı veya ortaya çıkan RCF değeri ve kalan süre gösterilir.



Süre dolduğunda ya da  tuşuna basılarak santrifügasyon çalışması kesildiğinde, belirlenmiş durma aşaması ile işlemin durması gerçekleşir. Durma aşaması \sim -f gösterilir.

Örnek: ekranı (RPM)

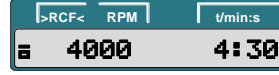
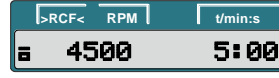

Örnek: ekranı (>RCF<)

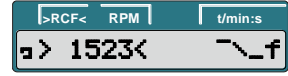
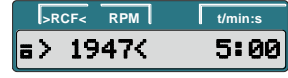

13.10 SÜREKLİ ÇALIŞMA



Gerektiğinde RPM ekranını (RPM) veya RCF ekranını (>RCF<) etkinleştirmek için tuşa basın.



İstenen santrifügasyon parametrelerini girin. t/min (s/dk) ve t/sec (s/sn) parametrelerini sıfıra ayarlayın



Santrifügasyon çalışmasını başlatmak için tuşa basın. Santrifügasyon çalışması sırasında rotor hızı veya ortaya çıkan RCF değeri ve kalan süre gösterilir.



Santrifügasyon çalışmasını sonlandırmak için tuşa basın. Belirlenmiş durma aşaması ile işlemin durdurulması gerçekleşir. Durma aşaması \sim -f gösterilir.

Örnek: ekranı (RPM)

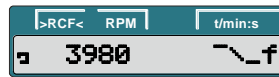

Örnek: ekranı (>RCF<)

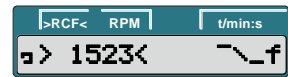

13.11 KISA SÜRELİ SANTRİFÜGASYON

- RCF
- Gerektiğinde RPM ekranını (RPM) veya RCF ekranını (>RCF<) etkinleştirmek için tuşa basın.
- ↓
- İstenen santrifügasyon parametrelerini girin
- ↓
- START PULSE
- Tuşa basın ve basılı tutun. Santrifügasyon çalışması sırasında rotor hızı veya ortaya çıkan RCF değeri ve geçen süre gösterilir.
- ↓
- START PULSE
- Santrifügasyon çalışmasını sonlandırmak için tuşu tekrar bırakın. Belirlenmiş durma aşaması ile işlemin durdurulması gerçekleşir. Durma aşaması ~\f gösterilir.

Örnek: ekranı (RPM)

>RCF<	RPM	t/min:s
4500		5:00

Örnek: ekranı (>RCF<)

>RCF<	RPM	t/min:s
> 1947<		5:00

>RCF<	RPM	t/min:s
4000		5:00

>RCF<	RPM	t/min:s
> 1538<		5:00

>RCF<	RPM	t/min:s
4000		0:24

>RCF<	RPM	t/min:s
> 1538<		0:24

>RCF<	RPM	t/min:s
3980		~\f

>RCF<	RPM	t/min:s
> 1523<		~\f

13.12 ACİL DURDURMA

- STOP OPEN
- Düğmeye iki kez basın. Acil Durdurma anında çalışmanın durdurulması "fast (hızlı)" durma aşamasıyla (kısa durma süresi) gerçekleşir. Durma aşaması ~\f gösterilir.

Örnek: ekranı (RPM)

>RCF<	RPM	t/min:s
4270		~\f

Örnek: ekranı (>RCF<)

>RCF<	RPM	t/min:s
> 1753<		~\f

13.13 DÖNGÜ SAYACI

Santrifüj, çalışma döngülerini (santrifügasyon işlemi) sayan bir döngü sayacı ile donatılmıştır. Her santrifügasyon çalışmasından sonra kapak kilitli kalan çalışma döngüsü sayısı (santrifügasyon çalışmaları) kısa bir süre için görüntülenir.

Örnek:

>RCF<	RPM	t/min:s
RemCycles=	16703	

Rotorun maksimum izin verilebilir çalışma döngüsü aşıldığında bir santrifügasyon çalışmasının başlatıldığı her seferde aşağıdaki bilgi gösterilir ve santrifügasyon çalışmasının yeniden başlatılması gerekir. Rotor, güvenlik sebepleriyle hemen yeni bir rotor ile değiştirilmelidir. Rotor değiştirildikten sonra döngü sayacı "0" a getirilmelidir.

Örnek:



13.14 DÖNGÜ SAYACININ SIFIRA AYARLANMASI

Rotor değiştirildikten sonra döngü sayacının tekrar sıfıra ayarlanması gereklidir. Döngü sayacı, ancak rotor yenisiyle değiştirildikten sonra sıfırlanabilir. Rotor durma halinde iken döngü sayacı aşağıdaki gibi sıfırlanabilir. Prosedür  tuşuna basılarak istendiği zaman kesilebilir. Bu durumda ayarlar kaydedilmez.



Tuşu sekiz saniye boyunca basılı tutun.



Aşağıdaki bilgi görüntülenene kadar tuşu basılı tutun.

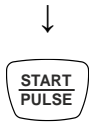

Düğmeye basın.

Örnek:

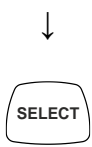

Aşağıdaki bilgi görüntülenene kadar tuşu basılı tutun:
Cyc sum (Döngü toplamı) : Tamamlanmış işlem döngüsü sayısı.

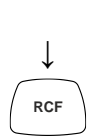

Düğmeye basın.



Düğmeye basın.
Tamamlanmış işlem döngüsü sayısı sıfıra ayarlanır.



Ayarları kaydetmek için düğmeye basın.

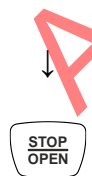

Tuşa "-> Time & Cycles" (Süre ve Döngü)" menüsünden çıkmak için iki kez veya "* MACHINE MENU (MAKİNE MENÜSÜ) *" menüsünden çıkmak için üç kez basın.



Örnek:



13.15 AYARLAR VE SORGULAR

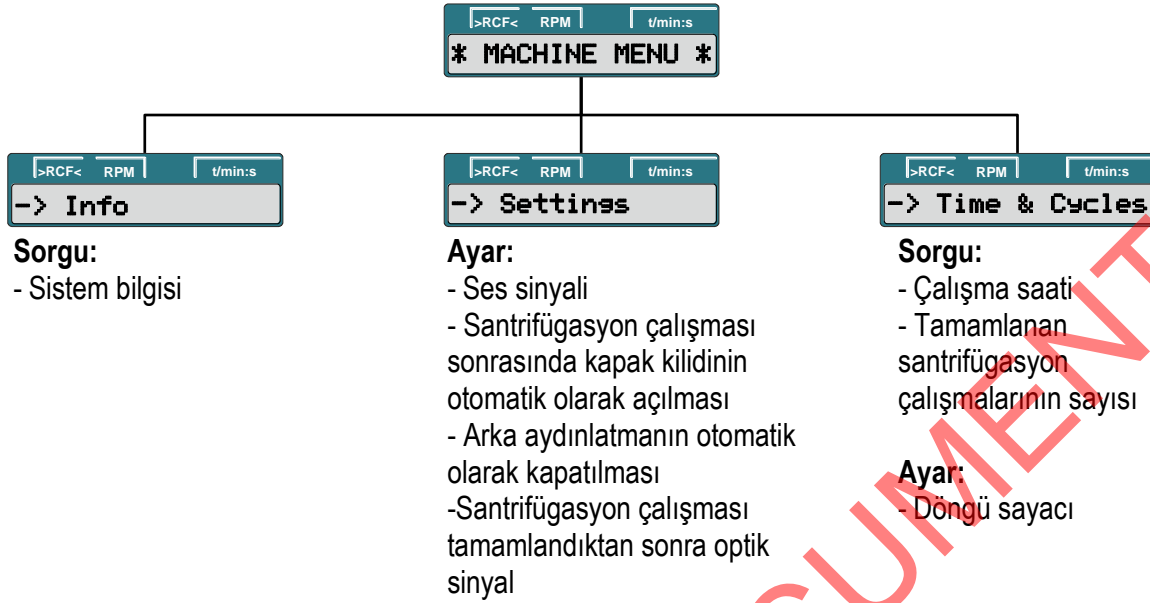





13.16 SİSTEM BİLGİSİ SORGULAMA

Aşağıdaki sistem bilgisi sorgulanabilir:

- Cihaz modeli,
- Cihazın program versiyonu,
- Cihazın tip numarası,
- Cihazın üretim tarihi,
- Cihazın seri numarası,
- Frekans konvertörü tipi
- Frekans konvertörünün program versiyonu

Rotor durma halinde iken sorgu aşağıdaki gibi işlenebilir: Prosedür  tuşuna basılarak istendiği zaman kesilebilir.

-  Tuşu sekiz saniye boyunca basılı tutun.
- ↓
-  Düğmeye basın.
- ↓
-  Düğmeye basın.
Cihaz modeli.
- ↓
-  Düğmeye basın.
Cihazın program versiyonu.

*** MACHINE MENU ***

-> Info

BOECO SC-8

Örnek:

CP FW= V02.00-05



Düğmeye basın.
Type#1 (Tip#1): Cihazın tip numarası.

Örnek:



Düğmeye basın.
Type#2 (Tip#2): "Type#1" ekran alanından daha fazla konumu varsa tip numarasının devamı.

Örnek:



Düğmeye basın.
Cihazın üretim tarihi.

Örnek:



Düğmeye basın.
Cihazın seri numarası.

Örnek:



Düğmeye basın.
Frekans konvertörü tipi.

Örnek:



Düğmeye basın.
Frekans konvertörünün program versiyonu.

Örnek:



Tuşa "-> Info (Bilgi)" menüsünden çıkmak için iki kez veya "* MACHINE MENU (MAKİNE MENÜSÜ) *" menüsünden çıkmak için üç kez basın.



Örnek:



13.17 SES SİNYALİ

Ses sinyali aşağıdakilerden sonra duyulur: (1) arıza meydana geldiğinde 2 saniyelik aralıklarla. (2) santrifügasyon çalışması sonlandığında ve rotor durduğunda 30 saniyelik aralıklarla. Ses sinyali, herhangi bir tuşa basıldığında sonlanır. Rotor durma pozisyonunda ise ses sinyali aşağıdaki gibi ayarlanabilir.

Prosedür  tuşuna basılarak istendiği zaman kesilebilir. Bu durumda ayarlar kaydedilmez.



Tuşu sekiz saniye boyunca basılı tutun.



Aşağıdaki bilgi görüntülenene kadar tuşu basılı tutun.





Düğmeye basın.

End beep (Sonlanma ikaz sesi) :

Santrifügasyon çalışması tamamlandıktan sonra sesli sinyal.

off (kapalı) : Sinyal devre dışı.

on (açık) : Sinyal etkin.

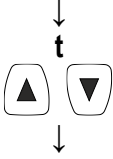

Tuşlar ile **off** veya **on** olarak ayarlayın.



Düğmeye basın.

Error beep (hata ikaz sesi) : Arıza oluştuğunda verilen ses sinyali.

off : Sinyal devre dışı.

on : Sinyal etkin.

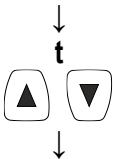

Tuşlar ile **off** veya **on** olarak ayarlayın.



Düğmeye basın.

Beep volume (ikaz sesi düzeyi) : Ses sinyali düzeyi.

min (en düşük) : yumuşak

mid (orta) : orta

max (en yüksek) : yüksek sesli

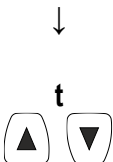

Tuşlar ile, **min**, **mid** veya **max** olarak ayarlayın.



Ayarları kaydetmek için düğmeye basın.



Tuşa "-> Settings (Ayarlar)" menüsünden çıkmak için bir kez veya "* MACHINE MENU (MAKİNE MENÜSÜ) *" menüsünden çıkmak için iki kez basın.



Örnek:



13.18 SANTRİFÜGASYON ÇALIŞMASI TAMAMLANDIKTAN SONRA OPTİK SİNYAL

Santrifügasyon çalışmasından sonra, santrifügasyon çalışmasının bittiğini görsel olarak işaret etmek için ekranın arka aydınlatması yanıp söner. Optik sinyal, rotor durma halindeyken açılabilir veya kapatılabilir.

Prosedür  tuşuna basılarak istendiği zaman kesilebilir.

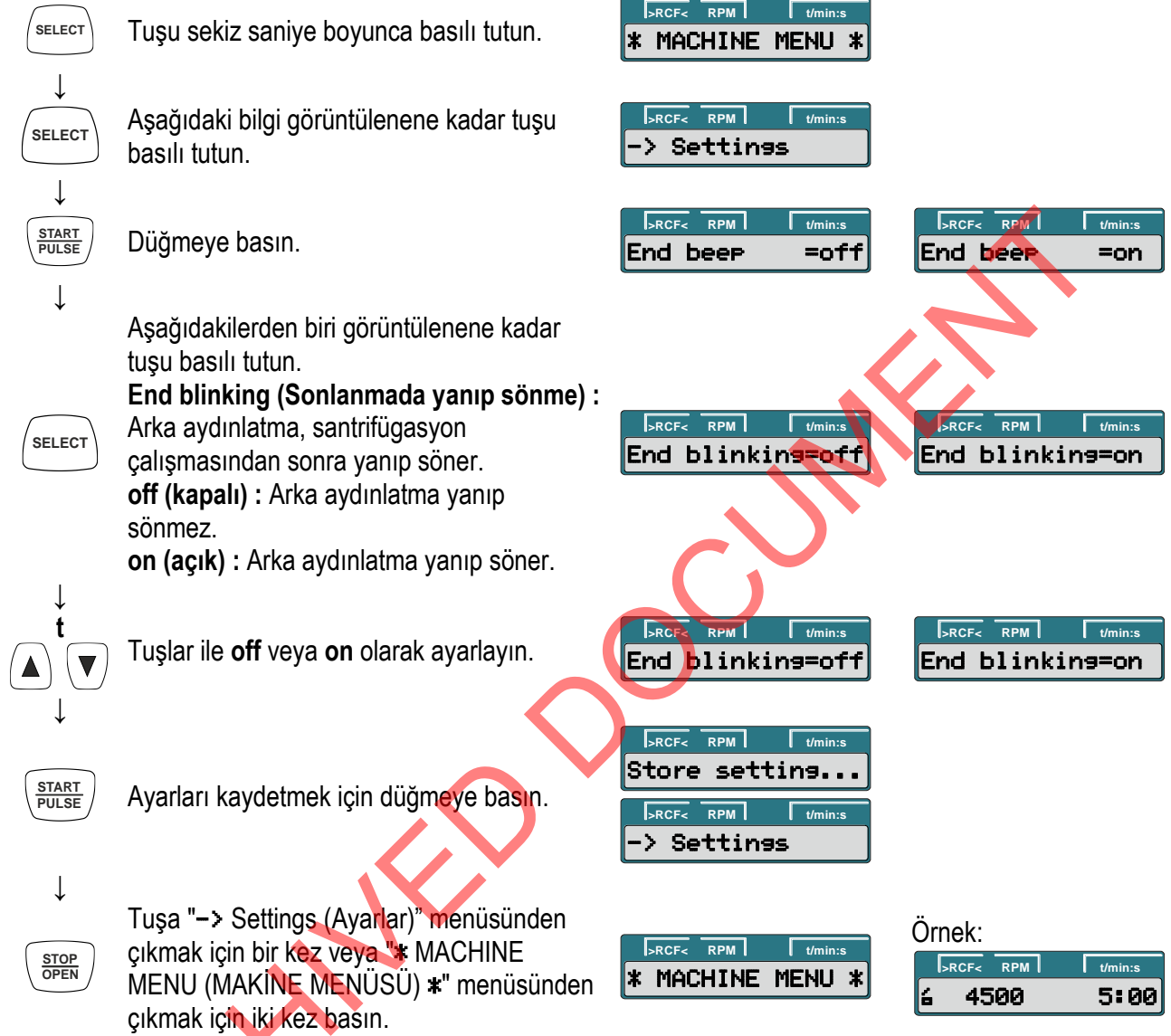

13.19 SANTRİFÜGASYON ÇALIŞMASI SONRASINDA KAPAK KİLİDİNİN OTOMATİK OLARAK AÇILMASI

Santrifügasyon çalışmasından sonra kapak kilidinin otomatik olarak açılıp açılmaması gerektiği ayarlanabilir. Rotor durma halinde iken aşağıdaki gibi ayarlanabilir. Prosedür  tuşuna basılarak istendiği zaman kesilebilir. Bu durumda ayarlar kaydedilmez.

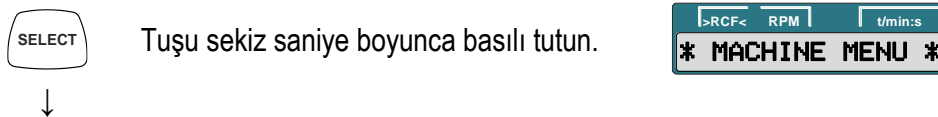



Aşağıdaki bilgi görüntülenene kadar tuşu basılı tutun.

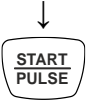

Düğmeye basın.



Aşağıdakilerden biri görüntülenene kadar tuşu basılı tutun.

Lid AutoOpen (Kapağı otomatik olarak aç) : Santrifügasyon çalışması sonrasında kapak kilidinin otomatik olarak açılması.
off (kapalı) : Kapak kilidi otomatik olarak açılmaz.
on (açık) : Kapak kilidi otomatik olarak açılır.

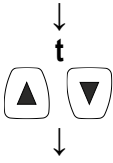

Tuşlar ile **off** veya **on** olarak ayarlayın.



Ayarları kaydetmek için düğmeye basın.



Tuşa "-> Settings(Ayarlar)" menüsünden çıkmak için bir kez veya "*MACHINE MENU*" (MAKİNE MENÜSÜ) menüsünden çıkmak için iki kez basın.



Örnek:



13.20 EKRANIN ARKA AYDINLATMASI

Enerji tasarrufu sağlamak için ekranın arka aydınlatması, santrifügasyon çalışmasının ardından 2 dakika sonra kapatılacak şekilde ayarlanabilir. Rotor durma halinde iken aşağıdaki gibi ayarlanabilir. Prosedür



tuşuna basılarak istendiği zaman kesilebilir. Bu durumda ayarlar kaydedilmez.



Tuşu sekiz saniye boyunca basılı tutun.

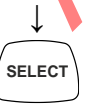

Aşağıdaki bilgi görüntülenene kadar tuşu basılı tutun.



Düğmeye basın



↓
Aşağıdakilerden biri görüntülenene kadar tuşu basılı tutun.



Power save (Güç tasarrufu) : Arka aydınlatma otomatik olarak kapatılır.
off (kapalı) : Otomatik kapatma devre dışı.
on (açık) : Otomatik kapatma etkin.



↓
Tuşlar ile off veya on olarak ayarlayın.



↓
Ayarları kaydetmek için düğmeye basın.



↓
Tuşa "-> Settings (Ayarlar) " menüsünden çıkmak için bir kez veya "* MACHINE MENU (MAKİNE MENÜSÜ) *" menüsünden çıkmak için iki kez basın..



Örnek:

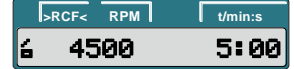

13.21 ÇALIŞMA SAATİ VE SANTRİFÜGASYON ÇALIŞMALARININ SAYISININ SORGULANMASI

Çalışma saatleri, dahili ve harici çalışma saatleri olarak ikiye ayrılmıştır. Dahili çalışma saatleri: Cihazın açık olduğu toplam süre. Harici çalışma saatleri: Önceki santrifügasyon çalışmalarının toplam süresi. Rotor durma halinde iken sorgu aşağıdaki gibi işlenebilir. Prosedür  tuşuna basılarak istendiği zaman kesilebilir.

↓
Tuşu sekiz saniye boyunca basılı tutun.



↓
Aşağıdaki bilgi görüntülenene kadar tuşu basılı tutun.



↓
Düğmeye basın.
TimeExt (Harici süre): Harici çalışma saatleri..



Örnek:



↓
Düğmeye basın.
TimeInt (Dahili süre): Dahili çalışma saatleri.



Örnek:





Düğmeye basın.
Starts (Başlatma): Tüm santrifügasyon çalışmalarının sayısı.



Tuşa "-> Time & Cycles (Süre ve Döngü) " menüsünden çıkmak için iki kez veya "* MACHİNE MENU (MAKİNE MENÜSÜ) *" menüsünden çıkmak için üç kez basın..

Örnek:



Örnek:

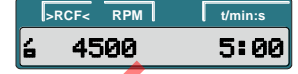



14 HATALAR

Aşağıdaki arıza tablosunun yardımıyla arıza giderilemezse, lütfen Müşteri Hizmetlerine başvurun ve santrifüj tipini ve seri numarasını belirtin. Her iki numara da santrifüjün isim plakasında bulunabilir.



MAINS RESET (ANA ŞALTER SIFIRLAMA) gerçekleştirin: Ana şalteri kapatın (şalter konumu "0"). En az 10 saniye bekleyin ve ana şalteri tekrar açın (şalter konumu "1").

Mesaj / hata	Neden	Çözüm	
Ekran yok	Voltaj yok Şebeke giriş sigortası arızalı.	<ul style="list-style-type: none">Dağıtım voltajını kontrol edin.Şebeke güç girişi sigortasını kontrol edin ve şebeke sigortasını değiştirmek için talimatlara bakın.Ana şalteri açın.	
IMBALANCE (DENGESİZLİK)	Rotor, eşit olmayan biçimde yüklenmiştir	<ul style="list-style-type: none">Kapağı rotor durur halde iken açın.Rotorun yüklenmesini kontrol edin.Santrifügasyon çalışmasını tekrarlayın.	
MAINS INTER (ŞEBEKE KESİNTİ)	11	<ul style="list-style-type: none">Kapağı rotor durur halde iken açın.Start/pause düğmesine basın.Gerekli ise santrifügasyon çalışmasını tekrarlayın.	
MAINS INTERRUPT (ŞEBEKE KESİNTİSİ)	Santrifügasyon çalışması sırasında güç arızası. (Santrifügasyon çalışması tamamlanmadı.)		
TACHO ERROR (TAKO HATASI)	1, 2	<ul style="list-style-type: none">Rotor durur halde ike MAINS RESET gerçekleştirin.	
LID ERROR (KAPAK HATASI)	4.1 – 4.127		Kapak kilitleme veya kapak örtme hatası.
OVER SPEED (AŞIRI HIZ)	5		Dönme çok hızlı
VERSION ERROR (VERSİYON HATASI)	12	<ul style="list-style-type: none">Rotor durur halde ike MAINS RESET gerçekleştirin.	
UNDER SPEED (DÜŞÜK HIZ)	13		Yanlış santrifüj modeli tespit edildi. Hata / arızalı elektronik parçalar Dönme çok yavaş

CTRL ERROR (CTRL HATASI)	22.1, 25.2	Hata / arızalı elektronik parçalar	
CRC ERROR (CRC HATASI)	27.1		
COM ERROR (COM HATASI)	31 – 36		
FC ERROR (FC HATASI)	60, 61.1 – 61.21, 61.64 – 61.142		
FC ERROR (FC HATASI)	61.23	Hız ölçüm hatası	<ul style="list-style-type: none"> – Dönme ekranı  yandığı ve döndüğü sürece cihaz kapatılamaz.  (kapak kilitli) sembolü görünene kadar bekleyin (yaklaşık 120 saniye sonra). Ardından, MAINS RESET gerçekleştirin.
TACHO ERROR (TAKO HATASI)	61.22		
FC ERROR (FC HATASI)	61.153	Hata / arızalı elektronik parçalar	<ul style="list-style-type: none"> – MAINS RESET (ANA ŞALTER SIFIRLAMA) gerçekleştirin. – Verilen talimatlara göre rotorun yüklenmesini kontrol edin. – Santrifügasyon çalışmasını tekrarlayın.

15 BAĞIL SANTRİFÜJ KUVVETİ (RCF)

Bağıl santrifüj kuvveti (RCF), yer çekimi ivmesinin (g) katı olarak verilir. Birimsiz değerdir ve separasyon ile sedimentasyon performansının karşılaştırılması işlevi görür. Bağıl santrifüj kuvveti (RCF), devir dakika ve santrifüj yarıçapı bağlamında durur. Aşağıdaki formül kullanılarak hesaplanabilir:

$$RCF = \left(\frac{RPM}{1000} \right)^2 \times r \times 1,118 \quad \Rightarrow \quad RPM = \sqrt{\frac{RCF}{r \times 1,118}} \times 1000$$

RCF = bağıl santrifüj kuvveti

RPM = dönme hızı (devire dakika)

r = mm olarak santrifüj yarıçapı = dönme ekseninin merkezinden santrifüj kabının alt kısmına olan mesafe.

16 TAŞIMA VE DEPOLAMA

Cihazın taşınmasından önce taşıma emniyeti aygıtı takılmalıdır. Cihaz ve aksesuarları yalnızca kapalı ve kuru odalarda depolanmalıdır. Cihaz ve aksesuarlar taşındığında veya saklandığında, aşağıdaki koşullara uyulmalıdır:

Ortam sıcaklığı: -20°C - +60°C.

Bağıl nem: %10 - %80, yoğunlaşmayan.

17 ŞEBEKE GİRİŞ SİGORTALARININ DEĞİŞTİRİLMESİ

Şebeke anahtarını kapatarak ve cihazı şebekeden ayırarak başlayın. Şebeke giriş sigortalarının bulunduğu sigorta yuvası (A), ana şalterin yanında yer alır. Bağlantı kablosunu, makinenin fişinden çıkarın. Esneyerek takılanı (B) sigorta yuvasına (A) itin ve çıkarın. Arızalı şebeke giriş sigortalarını değiştirin. Yalnızca üretici

tarafından sağlanan santrifüj tipi için tanımlanan sınıftaki sigortaları kullanın. Esneyerek oturan klik sesiyle yerleşene kadar sigorta yuvasını yerine koyun. Cihazı, tekrar şebeke kaynağına bağlayın.

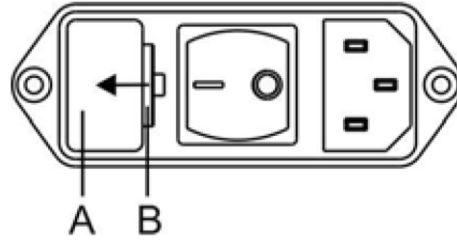

18 CİHAZLARIN İADE EDİLMESİ

Cihazı iade etmeden önce taşıma emniyeti aygıtı takılmalıdır. Cihaz veya aksesuarları yasal üreticiye iade edilirse, insanlar, çevre ve malzemeler için koruma sağlamak amacıyla, gönderilmeden önce dekontamine edilmeli ve temizlenmelidir. Yasal üretici, kontamine cihazları veya aksesuarları reddetme hakkını saklı tutar. Temizlik ve dezenfeksiyon maliyetleri, müşteri tarafından ödenir.

19 BERTARAF ETME

Bertaraf etmeden önce insanları, çevreyi ve malı korumak için cihazın kirliliği giderilmeli ve temizlenmelidir. Cihazı bertaraf ederken ilgili yasal kurallara uyulmalıdır. 2002/96/EC (WEEE) kılavuzu uyarınca, 13 Ağustos 2005 tarihinden sonra temin edilmiş cihazlar, evsel atık olarak atılamaz. Cihaz, 8. gruba (tıbbi cihazlar) aittir ve işletmeler arası alanda kategorize edilmiştir. Üzeri çizilmiş çöp kutusu ikonu, cihazın evsel atık olarak atılamayacağını göstermektedir. Her AB ülkesinin atık bertarafı kılavuzu farklılık gösterebilir. Gerekli ise tedarikçiniz ile irtibata geçiniz.



下面的符号表仅供参考. 有关适用的符号, 请参阅产品包装标签.

符号	符号说明
	注意
	电子使用说明
	制造商
	BioHorizons产品 带有 CE 认证标志, 并符合医疗器械指令 93/42/EEC 的要求
	参考/款号
	发运批号/生产批号
	请勿重复使用
	请勿重复灭菌
	有效期
	通过伽马辐照灭菌
	制造日期
	注意: 美国联邦法律规定这些器械仅限由牙医或医生或者遵医嘱销售、分发和使用

符号	符号说明
	起始位置
	如果包装损坏, 请勿使用
	医疗器械
	未灭菌
	保持干燥
	脆弱;小心轻放
	温度极限
	这面朝上
	湿度极限
	警告;生物危害
	重要笔记
	分开收集电气和电子设备。
	欧盟授权代表

1 使用说明

IntraSpin 系统旨在利用从患者床旁检测获取的少量血液样本中安全快速地制备自体富血小板纤维蛋白 (L-PRF)。将 PRF 用于骨质缺损之前，需要先将 L-PRF 与自体骨和/或异体骨进行混合以改善处理特性。遵守使用说明中的所有信息也是预期用途的一部分。

2 禁忌症

IntraSpin 离心机仅用于设备预期用途中所述的目的。该设备的任何其他使用均被视为非预期的。在以下一种或多种临床情况下，禁止使用 IntraSpin 离心机：患有酒精成瘾或精神病，血液异常，不受控制的糖尿病，甲状腺功能亢进，口腔感染，恶性肿瘤或最近 12 个月内发生过心肌梗死的患者。患有免疫系统受损的全身性疾病的患者（例如艾滋病），使用可能会损害植入部位愈合的药物的患者，病史较差或不遵守口腔卫生程序的患者。

参与抗凝治疗的患者。这些患者并未被排除在 PRF 的益处之外，相反，护理点必须在离心机上增加额外的时间以使分离有效地使用。

3 安全注意事项

- 只有在遵循手册中的所有说明的情况下，制造商才会考虑受理质保要求。
- 操作说明是设备的一部分。它们必须始终保持随时可用。如果将设备安装在其他位置，则必须随附操作说明。
- 离心机应当安装在良好稳定的基座上。
- 在使用离心机前一定要检查转子以确保其已稳固安装。
- 依据 EN / IEC 61010-2-020，当离心机运转时，人、危险物质或物体都不得位于离心机周围 300 毫米的安全界限内。
- 已有腐蚀痕迹或机械损坏或者使用期限已过的转子、悬架和附件不可再使用。
- 离心机的离心室如有关乎安全的损坏，则该离心机不可再使用。
- 对于缺少温控的离心机，当室温升高和/或频繁使用设备时，离心室可能会升温。因此，不排除样品材料会因温度而发生变化的可能。
- 在您首次操作离心机之前，您应当阅读并重视操作说明书。只有阅读并理解了操作说明书的人员才可操作本设备。
- 除了操作说明书和事故预防法规之外，您还应当遵守为确保您以安全专业的方式工作的认可的职业规范。应当结合任何其他基于设备使用地所在国家的法规制定的有关事故防御和环境保护的说明一起阅读操作说明书。

- 使用者符合特定国家有关就该目的在工作场所使用离心机的职业安全要求是使用者的职责。
- 本离心机是一台最先进的设备，操作起来及其安全。不过，如果由未经培训的人员以不恰当的方式使用，或者将其用于预期用途之外的目的，则可能导致危险。
- 在操作过程中不得移动或敲打离心机。
- 在出现故障或紧急释放时，请勿在其停止运转之前触碰转子。
- 当由冷房转移到暖房时，为防止离心机因冷凝损坏，在接通电源以前必须在暖房里预热离心机至少 3 小时，或者在冷房里运行升温 30 分钟。
- 当以每分钟最大转速进行离心时，材料或材料混合物的密度不得超过 1.2 千克/立方厘米。
- 只有其平衡性在可接受范围内时才可操作离心机。
- 不可在有爆炸危险的区域操作离心机。
- 不可将离心机与以下材料一起使用：易燃或爆炸性的材料 彼此间发生反应产生大量能量的材料。
- 对于本离心机没有可用的生物安全系统。
- 不得用本离心机离心高腐蚀性物质，该类物质可能损害转子、悬架和附件的机械完整性。
- 修理工作只能由制造商授权的人员进行。
- 为了给患者提供最高水平的临床安全，IntraSpin 产品采用与人体血浆具有生物相容性的材料制作而成。
- 本产品并未获准可在所有市场销售，所以有可能在您所在的市场不适用。请咨询您当地的代表获取其他信息。

4 INTRASPIN 系统组件

零件	每个系统的数量
IntraSpin 离心机包括:	1
电源线	1
保险丝	2
六角扳手	1
Greiner 采血管和平衡管 (一次性使用)	150

Greiner 安全采血套件+固定器, 21G (单次使用)	24
乳胶止血带	1
试管架	1
外科弯曲剪刀	1
手术组织钳	1
圆形不锈钢碗	1
矩形不锈钢碗	1
双生物材料载体刮刀	1
双生物材料包装机	1
Xpression® 组件	1

仅推荐并担保直接与 IntraSpin 离心机一起使用的经过验证的兼容组件:

兼容零件号	描述
455092	Tube 9ml CAT 血清凝块激活剂, 红色盖
455001	白色无盖 9 Z ml 管
BHEXZ (E613)	IntraSpin 六角扳手 110v 和 220v
BROTORZ (E3694)	IntraSpin 转子, 100v 和 220v
BPOWER110Z (E1673)	IntraSpin 电源线, 110v
BPOWER220Z (E1669)	IntraSpin 电源线, 220v
BTUBEHOLDZ (E872 x 1)	IntraSpin 管支架更换
BFUSE110Z (E997)	IntraSpin 保险丝 110v
BFUSE220Z (E891)	IntraSpin 保险丝 220v

5 简要离心设置

从离心机底部卸下并保存运输螺栓。

连接交流电缆并插入电源插座。

使用设备背面的翘板开关打开离心机。

选择速度和时间: 速度 = 2700 & 时间 = 12:00 分钟

按 START (开始) 。

离心机盖会在每个循环结束时自动打开。

完成首次操作后，除非更改设置，否则离心机存储器会记录时间和速度。

6 采血管和采血套件注意事项及使用说明

- 如有异物，请不要使用采血管。
- 必须允许采血管完全填满。
- 请根据您所在设施的政策及程序处理所有生物样本和采血“锐器”（例如，针头和采血套件）。
- 请勿弯曲针头。
- 激活针头安全机制后，请勿强行拆解或重新激活。
- 由于可能传播 HIV（艾滋病），病毒性肝炎或其他传染病，因此如果接触生物样品（例如通过穿刺伤），应获得适当的医疗护理。
- 将所有采血“利器”丢弃在认可的生物危害容器中。
- 不建议将样品从注射器转移到试管中。
- 如果通过静脉（IV）管路收集血液，请在开始填充血液收集管之前，按照您所在机构的政策和程序，确保已清除管路中的 IV 溶液。
- 凝血促进剂在试管表面可能看起来是白色的，这对试管的性能没有影响。如果试管中还存在其他变色或沉淀，则不应使用。
- 试管到期后请勿使用。
- 请将采血管存放于 4–25°C (40–77°F) 环境。
- 请将采血套件（针头及管座）存放于 4–36°C (40–97°F) 环境。
- 避免暴露在直射的阳光下。超过建议的最高存储温度可能会导致灯管质量下降（即真空损失，变色等）。
- 为防止倒流，将患者的手臂放在向下的位置，盖好管盖并向上提，在血液开始流入管内后立即松开止血带，避免在静脉穿刺期间管内的东西与盖或针头接触。
- 进行静脉穿刺之前，请确保以下材料易于取用：所有必需的采血管，用于正确的患者识别样品的已标识标签，采血针和支架，用于清洁穿刺部位的酒精棉签，干净的纱布，止血带，橡皮膏或绷带，已批准的生物危害容器。为了防止暴露于血源性病原体，建议使用适当的 PPE（个人防护设备）（例如手套，实验室外套，护目镜等）。

静脉穿刺技术和血液样本采集：

由于收集管中没有抗凝剂，因此必须尽快进行血液收集。血液样本将立即开始凝结。在静脉穿刺期间以及在操作采血管时要戴手套，以最大程度地减少暴露的危险。在抽血之前，用您选择的消毒湿巾擦拭血管盖的顶部。取下针阀部分的盖子。准备静脉穿刺部位并使用适当的杀菌剂。清洁后请勿触诊静脉穿刺区域。将患者的手臂向下放置。取下针头护罩。进行静脉穿刺，手臂朝下，管盖朝上。必要时，请用胶带固定针头。将采血管推入支架，然后推到针阀上，刺破采血管的橡胶膜。穿过盖子时，将采血管对准支架的中心，以防止侧壁穿透和随后的过早真空损失。一旦血液进入采血管，请移除止血带。在操作过程中，请始终用拇指将收集管固定在适当的位置。这样可以确保完全由真空来抽血。采血管将自动填充。如果没有血液流入采集管，或者在采集足够的标本之前血流停止，建议采取以下步骤完成满意的采集：

- 向前推动采血管，以确保盖子已被刺穿。
- 确认针在静脉中的正确位置。
- 如果仍然没有血液流动，请取出并适当丢弃收集管。获取一个新的收集管并推入支架。
- 如果第二根收集管没有抽出，请取出并适当丢弃针头和收集管。重复该过程。
- 当达到采血管的最大填充线时，将其从固定架上轻轻取下。用第二个采血管重复上述步骤。

·从支架上取下后，立即轻轻地翻转每个收集管。不要摇动装有血液样本的试管。剧烈混合可能导致起泡或溶血。血清管中混合不充分或混合延迟可能会导致凝血延迟。

血样采集完成后，请从静脉中取出针头。按压针座两侧，即可激活针头安全机制（防护罩）以开启锁定。向后滑动安全机制，直到听见咔哒声。请勿回套针头，这样会增加针头刺伤和血液暴露的风险。请使用适当的生物危害处置容器处理用过的针头及管座。用干燥的无菌棉签对穿刺部位施加压力，直到出血停止。如果需要，一旦发生凝结，请包扎绷带。建议将充满的收集管保持直立位置。一旦第二个采血管已装满，将其取出并将第一和第二个管放在离心机的相对位置以平衡转子。关闭 IntraSpin 离心机的盖子，然后按 START（开始）按钮使其旋转 12 分钟。

若需要两管以上的血液，请遵循以下替代程序：装满前两根采血管并轻柔倒置后，立即将它们放入 IntraSpin 离心机中的相对位置上，以确保离心机妥为平衡。合上盖子并按“开始”按钮，并在收集剩余血液管的同时让离心机运行。按下“停止”按钮，使离心机完全停止。盖子将弹出。立即将剩余的试管放置在彼此相对的离心机中，以确保适当的平衡，然后按“开始”按钮重置并完成推荐的操作规程。

始终将采血管成对放置在相对位置以平衡离心机转子按下 START (开始) 按钮之前，采血管必须始终在转子中保持平衡，否则可能会对离心机造成严重损坏，使血液发生不当凝结和/或分离。如果试管平衡不当，则离心过程中振动会太大，从而导致 L-PRF 纤维蛋白凝块变差。

如需对奇数量的血样进行离心，请在带白色盖子的平衡管（例如 455001）中装入达到最高注水线的水，然后放入转子中未配对采血管的对侧。这样即可保持离心机的适当平衡。

采集血样后立即开始离心。延迟会影响血液分离过程，并导致不良的 L-PRF 纤维蛋白凝块。

7 L-PRF 制备

经过离心，管内血液分为三层：

1. 上层 = 贫血小板血浆 (PPP)。
2. 中层 = 纤维蛋白凝胶：L-PRF®。
3. 下层 = 红细胞凝胶。

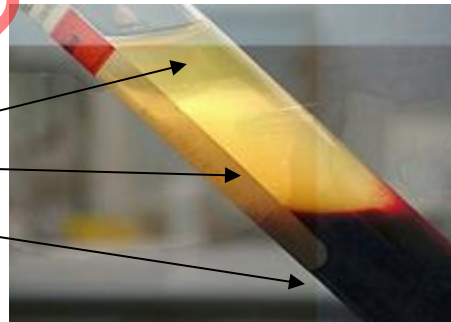

L-PRF 纤维蛋白膜或栓必须相对较快地制备：离心 0-15 分钟后，否则凝块会通过释放捕获的血清而缩小体积。离心后，从每个管子上卸下橡胶塞。使用外科组织钳将 L-PRF 凝块从管中取出。使用双重生物材料载体刮刀轻轻地从联合处下方的 L-PRF® 纤维蛋白凝块上刮下红细胞凝块，以便仅将少量残留的红细胞附着在 L-PRF 凝块上。将纤维蛋白凝块放在 Xpression 穿孔纸盘上。

8 纤维蛋白基质的制备

方案 1 L-PRF 膜

将每个纤维蛋白凝块放在 Xpression 穿孔纸盘上。放置所有血纤蛋白凝块后，将 Xpression 压缩板和 Xpression 称重盖放在血纤蛋白凝块上，而不会对血凝块施加任何压力。

在渗出液过滤到托盘底部的同时，让盖子的重量缓慢向下压血纤蛋白凝块。请勿对配重盖施加压力。在加重的覆盖物上的重力将轻柔地压缩血凝块并从 L-PRF 血凝块表达血清，而不会损坏血纤蛋白网络。

至少等待 5 分钟，然后再去除和使用任何纤维蛋白膜。在实际使用之前，请勿去除任何纤维蛋白膜。纤维蛋白膜可以在 Xpression Box 中保留长达 3 小时的时间。

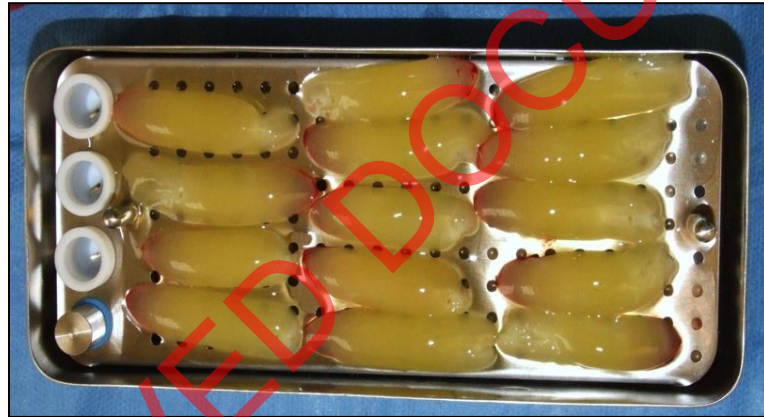

方案 2 L-PRF 插头

将纤维蛋白凝块放入白色塞子制造圆柱体中。用活塞缓慢将白色 L-PRF 塞子制造缸内的血块压入。继续按直到活塞的顶部边缘与白色 L-PRF 阀芯制造缸的顶部边缘齐平。通过这种技术，人们将能够为抽出插座形成一个厚的圆形纤维蛋白塞。对于单颗牙齿，一个 L-PRF 塞子就足够了。前臼齿可能需要两个 L-PRF 塞子，而臼齿可能需要三个 L-PRF 塞子，具体取决于提取套筒的大小和所产生的血纤蛋白凝块的大小。

L-PRF® 的工作特性可提供一种能与您的首选生物材料结合使用的优良介质。利用以下任何混合方案，都能增加在纤维蛋白基质中捕获的生物材料的处理和生物学能力。

方案 3 - 生物材料 / L-PRF 混合物

如需创建可使用生物材料内容物轻松形成所需形状和厚度的“油灰样”混合物，可使用以下方案：在带有外科弯曲剪刀的无菌培养皿中，将 L-PRF 纤维蛋白膜轻轻切成小块。添加所需量的骨移植材料。L-PRF® 和骨移植材料彻底混合均匀。可使用双重生物材料载体刮刀将此混合物置于缺陷中。



方案 4 - 生物材料 / L-PRF 基质混合物

将预定量的骨移植材料放入无菌碗或无菌盘中。将表达的 L-PRF 膜或 L-PRF 膜碎片浸入覆盖有 L-PRF 膜整个表面的接枝材料中。或者，可以将移植物材料撒在覆盖有整个表面区域的 L-PRF 膜上，并用移植物材料覆盖。注意：相对于较干的 L-PRF 膜，较湿的 L-PRF 膜可保留更多的接枝材料。接枝材料应粘在 L-PRF 的表面，但是，如果需要，可将接枝材料轻轻地压在 L-PRF 膜上。手术组织钳可用于将该混合物放入缺损处。

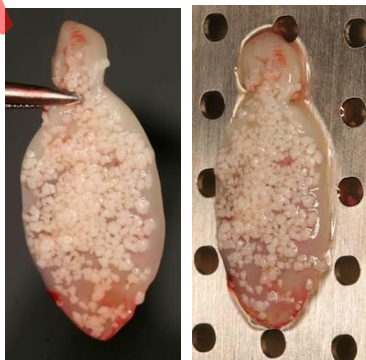

方案 5 - 生物材料水化

将所需量的骨移植材料添加到无菌碗或托盘中。利用 Xpression Collection Tray 底部的渗出液水化移植材料。充分混合渗出液和骨移植材料。可使用双重生物材料载体刮刀将此混合物置于缺陷中。

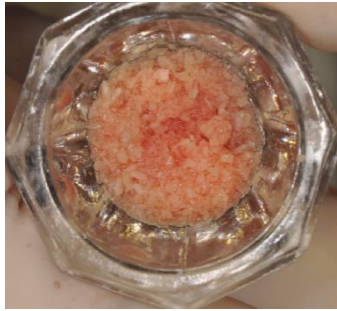

9 组织再生套件的清洁和消毒

Xpression® 制备盒可以轻松制造恒定厚度的纤维蛋白膜。渗出液可从 Xpression 多孔托盘下方的 Xpression 收集托盘中收集。Xpression 盒包括 L-PRF 塞子制造缸和一个活塞，用于制造 L-PRF 塞子，这些塞子容易安装在提取后的插座上。



Xpression 加重封盖



Xpression 压力板



Xpression 穿孔盘在 Xpression 收集盘中的

Xpression 盒和辅助仪器提供时并没有灭菌。第一次灭菌之前，请移除并丢弃所有运输材料。每次使用前都要对 Xpression Box 和辅助仪器进行清洁和消毒。

在每个清洁和灭菌周期之前，请拆解 Xpression 盒子，以避免碎屑包裹，材料变色和/或组件干燥不足。L-PRF 塞子制造缸和活塞环不需要从 Xpression 多孔板中取出进行清洁和消毒。

清洗: (1) 使用软毛刷和广谱清洁剂或消毒剂 (例如 Hu-Friedy 的 Enzymax® 或同等产品), 从 Xpression 盒子组件和辅助仪器中清除所有可见的碎屑。彻底冲洗。(2) 将 Xpression 盒组件和辅助仪器放在适当大小的相同溶液容器中, 并声处理 10 分钟。彻底冲洗。(3) 用异丙醇冲洗 Xpression 盒的组件和辅助仪器, 以除去任何肥皂残留物和矿物质。(4) 用不起毛的毛巾吸干 Xpression 盒的组件和辅助仪器, 并完全风干。有关使用说明, 请参阅所用清洁剂的标签。

消毒: (1) 将重新组装的 Xpression 盒和辅助仪器放在经过 FDA 许可的灭菌袋或包装中。
(2) 执行以下合格的灭菌循环之一:

灭菌方法	温度	接触时间	最短干燥时间
真空前蒸汽 (ANSI/AAMI ST79)	132°C (270°F)	4 分钟	20-30 分钟
真空前蒸汽 (UK DoH Health Technical Memorandum 01-01)	134°C (273°F)	3 分钟	20-30 分钟

注意! 清洁不当可能导致灭菌不足。高压灭菌过程中未能完全干燥 Xpression Box 组件和辅助仪器可能会留下水分, 并导致变色和氧化。使用过氧化氢或其他氧化剂会损坏 Xpression Box 组件和辅助仪器的表面。建议对高压灭菌器设备进行定期测试, 清洁和校准, 以确保设备保持正常的工作状态。

10 离心清洁和维护

本设备可能会被污染。在清洁之前拔掉电源。离心机、转子和附件不可在洗涤机中清洁。它们只能手工清洁并用液体消毒。水温必须在 20-25°C 之间。只能使用 pH 值为 5-8 且不含腐蚀性碱, 过氧化物, 氯化物, 酸和碱溶液的清洁剂/消毒剂为了防止清洁剂或杀菌剂导致的腐蚀现象, 必须绝对仔细地阅读清洁剂或杀菌剂制造商的使用指南。

为了防止附着在设备上的杂质的腐蚀, 可使用肥皂或温和清洁剂及湿布清洁。如有必要, 定期清洁离心机外壳和离心室。合适的洗涤剂的成分包括肥皂, 阴离子表面活性剂和非离子表面活性剂。使用清洁剂后, 用湿布擦除残留的清洁剂。清洁之后必须立即干燥表面。如有凝结水形成, 请用吸水布擦干离心室。每次清洁之后, 用滑石粉或橡胶护理产品轻轻擦抹离心室的橡胶密封。应检查离心室是否损坏。如果发现可影响安全性的损坏, 离心机就不可再投入使用。在该情况下请通知客服中心。

表面消毒: 如果传染性物质渗入了离心室, 则需要立即消毒。合适的消毒剂的成分包括乙醇, 正丙醇, 乙基己醇, 阴离子表面活性剂和腐蚀抑制剂。使用消毒剂后, 用湿布擦除残留消毒剂。消毒后必须立即干燥表面。

去除放射性污染物: 去污剂必须是特别标明用于去除放射性污染物的试剂。用于去除放射性污染物的合适试剂的成分包括阴离子表面活性剂, 非离子表面活性剂, 多元水乙醇。去除放射性污染物后, 用湿布擦除残留的试剂。去除放射性污染物后必须立即干燥表面。

11 转子和附件 清洁与保养

为了防止腐蚀和对材料的改变, 必须定期使用肥皂或温和的清洁剂和湿布清洁转子和附件。建议一周至少清洁一次。必须立即去除污染物。

合适的洗涤剂的成分包括肥皂, 阴离子表面活性剂和非离子表面活性剂。使用清洁剂后, 用水冲洗 (仅限在离心室外) 或用湿布擦除残留的清洁剂。清洁之后必须立即干燥转子和附件。每周检查一次转子和附件以确保没有磨损和腐蚀。转子和附件如有磨损和腐蚀迹象, 就不可再使用。每周定期检查转子定位的牢固性。如果传染性物质附在了转子或附件上, 必须对它们进行适当的消毒。

合适的消毒剂的成分包括乙醇, 正丙醇, 乙基己醇, 阴离子表面活性剂和腐蚀抑制剂。使用消毒剂后, 用水冲洗 (仅限在离心机外) 或用湿布擦除残留的消毒剂。转子和附件必须在消毒之后立即干燥。

用于去除放射性污染物, 试剂必须是特别标明用于去除放射性污染物的试剂。用于去除放射性污染物的合适试剂的成分包括阴离子表面活性剂, 非离子表面活性剂和多元乙醇。去除放射性污染物后, 用水冲洗 (仅限在离心机外) 或用湿布擦除残留的试剂。去除放射性污染物后必须立即干燥转子和附件。

转子可在 121°C / 250°F 高压灭菌 20 分钟, 然后适当干燥。出于安全考虑, 在 10 个灭菌周期后应更换转子。高压灭菌会加速塑料的老化过程, 并可能导致变色。高压灭菌后, 等转子冷却至环境温度后再使用。不能做有关无菌程度的说明。

转子的使用期限限制为 50,000 个运行周期（离心运行）或 5 年，以先到者为准。最大允许运行周期数可在转子上看到。出于安全考虑，当转子达到允许的最大运行周期数（标记于转子上）时，转子就不可再使用。设备装有循环计数器，会计算运行周期（离心运行）数。

万一发生血管破裂，应彻底清除所有破裂的部分和血液。离心机应按照指示进行彻底清洁，并应更换转子的橡胶衬套和塑料套。

12 离心技术规格

型号类型	IS220Z	IS110Z
电源电压 (± 10%)	200 - 240 伏 1~	100 - 127 伏 1~
电源频率	50 - 60 赫兹	50 - 60 赫兹
连接负载	100 伏安	100 伏安
电流消耗	0.5 安	1.0 安
容量	8 x 10 毫升	
最大允许密度	1.2 千克/立方分米	
最大速度 (每分钟转数)	6,000	
力 (相对离心力)	3,461	
动能	750 牛米	
安装地点	仅室内	
海拔	最高海平面以上 2,000 米	
运行环境温度	5° C 到 40° C	
相对湿度	31°C 以下最高相对湿度 80%, 40°C 时线性降低至 50%。	
过电压类型	II	
污染程度	2	
设备防护等级	I	
	不适于在有爆炸危险的区域使用。	
辐射干扰, 抗干扰性	EN / IEC 61326-1, 等级 B	FCC 等级 B
噪声等级 (依据转子而不同)	≤ 50 分贝 (A 声级)	
离心机宽度	261 毫米	
离心深度	353 毫米	
离心机高度	228 毫米	
离心机重量	约 9 千克	

13 离心机操作说明

必须拆除由 2 (a) 个螺钉和 2 (b) 个垫片组成的运输固定装置。将运输保护装置保存在安全的地方，因为下次运输本设备前将需要再次安装保护装置。只有在安装了运输保护装置后才可运输本设备。将转子固定在一个位置以避免设备在运输过程中受到损坏。当操作设备时，必须移除运输保护装置。

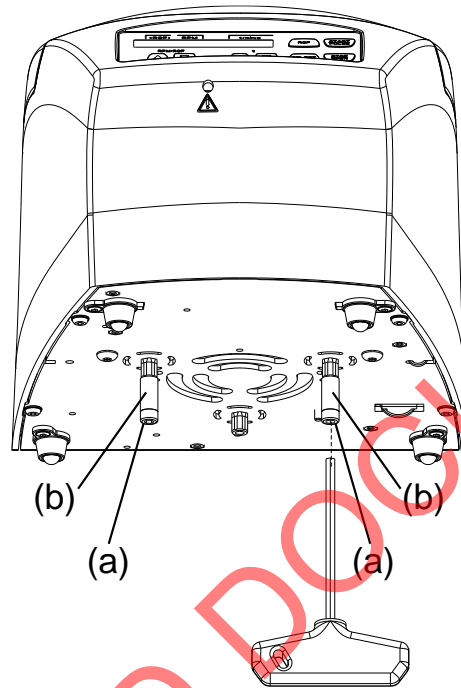

13.1 初次操作

- 从离心机底侧卸下运输固定装置。
- 在合适的位置稳定水平放置离心机。当离心机运转时，人、危险物质或物体都不得位于离心机周围 300 毫米的安全界限内。
- 不可挡住通风口。从离心机的开口和通风槽开始须保留 300 毫米的距离。
- 检查电源电压是否符合铭牌上的说明。
- 将离心机的电源线接到标准电源插座上。
- 接通电源开关。
- 面板上显示以下内容：离心机型号，软件版本和最后使用的离心数据。
- 如果机盖呈关闭状态，则会显示“Open the lid（打开机盖）”信息。在此情况下，请打开机盖以显示离心数据。

13.2 打开和关闭离心盖

只有在离心机通电、转子静止的情况下才能打开机盖。当离心机开始运行且循环计数器开启后，打开机盖时会短暂显示剩余的运行循环（离心运行）数。



示例：



要打开盖子，请按以下键。机盖被电机解锁。表示机盖已解锁。



示例：

请勿将手指探入机盖和外壳之间。不要猛力关闭机盖。

要合上盖子，请轻轻向下按盖子的前边缘。表示盖已锁定。

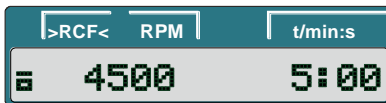

示例：

13.3 紧急解锁

在停电的情况下，机盖无法由电机解锁。紧急解锁必须手动进行。要在紧急情况下解锁，关闭电源开关（开关设在“0”位置）。通过机盖的窗户向里看，确保转子处于静止状态。仅在转子停止时打开机盖。将内六角扳手沿水平方向插入孔（A），然后小心地逆时针（向左）旋转，直到机盖打开。注意！沿顺时针方向（右侧）转动六角六角扳手可能会损坏锁定系统。将内六角扳手从孔中取出。

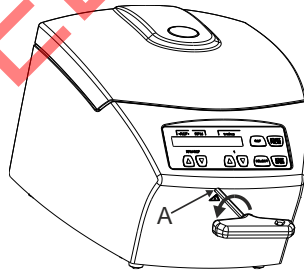

13.4 安装和移除转子

要卸下转子，用内六角扳手（随货附带）逆时针旋转以松开转子上的夹紧螺母，然后上移至提升压力点。越过提升压力点之后，转子就从电机轴的锥体中脱出。旋转夹紧螺母直到转子能够从电机轴上拿起。将转子从电机轴上拿下来。

要安装转子，清洁电机轴（A）以及转子孔，然后在电机轴上涂一薄层油脂。电机轴和转子之间的灰尘粒子会使转子底座不良，并导致其运转时不稳定。将转子垂直放置在电机轴上。安装转子时，转子上的标记梁（B）必须同时与电机轴的两个表面（C）平行。用内六角扳手（随货附带）顺时针旋转以拧紧转子上的夹紧螺母。检查转子以确保其安置稳固。

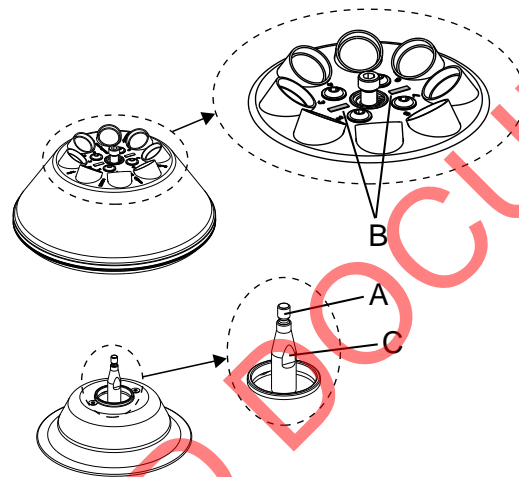

转子必须对称加载。血液管必须均匀分布在所有转子位置上。



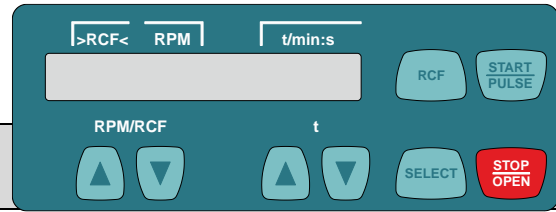

血液管只能在离心机外部填充。血液管的最大填充量在血液管本身上指定，并且不得超过转子上列出的最大重量。离心容器的填充应以离心机运行时没有液体溅出为准。当加载转子时，不能有液体进入转子或离心室。为了使离心容器内的重量差异尽可能小，建议在血管中保持一致的填充水平。

13.5 显示元素说明



符号/面板按钮	描述
	机盖解锁。
	机盖锁住。
	旋转显示。在转子旋转期间，旋转显示亮起, 转子顺时针旋转。
	直接输入速度值。如果一直按住该键，数值将加速改变。
	直接输入运转时间。可以按秒调节，最大调节量为1分钟，也可从1分钟开始，按1分钟幅度调节。输入离心参数。如果一直按住该键，数值将加速改变。
	激活单个参数。每次按下该键，下一个参数就会被激活。按住该键8秒钟以调用“MACHINE MENU”（机器菜单）。在“Machine Menu”（机器菜单）中，选择菜单“-> Info（信息）”、“-> Settings（设置）”和“-> Time & Cycles（时间和循环）”。在菜单里向前滚动。
	在速度显示（RPM）和相对离心力显示（RCF）之间切换。RCF值显示在箭头><之间。
	开始离心运行。短期离心运行。如一直按住该键，离心将持续运行。选择菜单“->Info”, “->Settings”和“->Time & Cycles”。
	结束离心运行。转子在预选的制动阶段停止。按该键两次将触发紧急停机。解锁机盖。
t/min (时间/分)	运行时间。在1-99分钟范围内可按1分钟的幅度调节。
t/sec (时间/秒)	运行时间。在1-59秒的范围内可按1秒钟的幅度调节。持续运行“:-:”。设置参数 t/min 和 t/sec 为零。
RPM	速度。可以用在200转每分和转子的最高速度之间的一个数值进行设置。可以10每分转的幅度调节。
>RCF<	相对离心力。可以设置数字值，使速度处于200每分转和最大转子转速之间。可以按1每分转的幅度调节。仅在相对离心力（>RCF<）显示启用后才可输入相对离心力（RCF）数值。相对离心力（RCF）的大小视离心半径（RAD）而定。在输入相对离心力值后，请检查以确保设置了正确的离心半径。
RAD/mm	离心半径。可在10毫米和250毫米之间调节，调节幅度为1毫米。仅在相对离心力显示（>RCF<）启用后才可输入离心半径数值。
~_DEC	制动阶段：fast（快速）= 短制动时间；slow（慢速）= 长制动时间

13.6 离心参数的直接输入

速度（RPM）、相对离心力（RCF）、离心半径（RAD）以及运行时间都可以通过   键直接键入，而不用提前按  键。设置的离心参数仅在开始离心运行之后才会被储存。

速度（每分钟转数）：

 按需要启用每分钟转数（RPM）显示。

RPM/RCF 利用按键设置需要的数值。



示例：



相对离心力（RCF）和离心半径（RAD）：

 按照需要启用相对离心力（>RCF<）显示。

RPM/RCF 利用按键设置需要的相对离心力数值。



t 按照需要利用按键设置需要的离心半径。



示例：

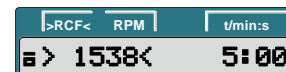
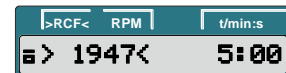

运行时间：

对于1分钟及以下，运行时间可以按1秒的幅度设置；从1分钟开始，只能按照1分钟的幅度设置。为了设置持续运行，参数 t/min（时间/分）和 t/sec（时间/秒）必须设置为零。在时间显示（t/min:s）中出现“--:--”。



t 利用按键设置需要的数值。



示例：





13.7 用“SELECT (选择)”键输入离心参数

运行时间可以设置为分和秒 (参数 t/min (时间/分) 和 t/sec (时间/秒))。

为了设置持续运行, 参数 t/min 和 t/sec 必须设置为零。在时间显示 (t/min:s) 中出现 “--:--”。

示例：

相对离心加速 (RCF) 的大小视离心半径 (RAD) 而定。在输入相对离心加速过程中, 会显示设置的离心半径。如在选择后或在参数输入过程中没有按键达到 8 秒钟, 就会显示之前的数值。然后参数必须重新输入。通过按住  按钮, 设置将被保存。

如果输入了数个参数,  必须在设置最后一个参数后按此键。

通过按  键可以在任何时候取消输入参数。在该情况下, 设置将不会保存。

RCF

按照需要按此键启用每分钟转数显示 (RPM) 或相对离心力显示 (>RCF<)。

SELECT

按键。
t/min : 运行时间, 分钟。



利用按键设置需要的数值。

SELECT

按键。
t/sec : 运行时间, 秒钟。



利用按键设置需要的数值。

按按键。
RPM : 速度。
RAD/mm : 离心半径。
只有在相对离心力显示 (>RCF<) 启用后才可显示并输入离心半径数值。

示例：每分钟转数显示 (RPM)

示例：相对离心力显示 (>RCF<)



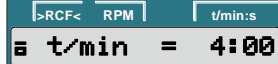



13.8 控制面板显示

在每次离心运行之后，当机盖解锁时，会简要显示剩余的运行循环（循环运行）数。

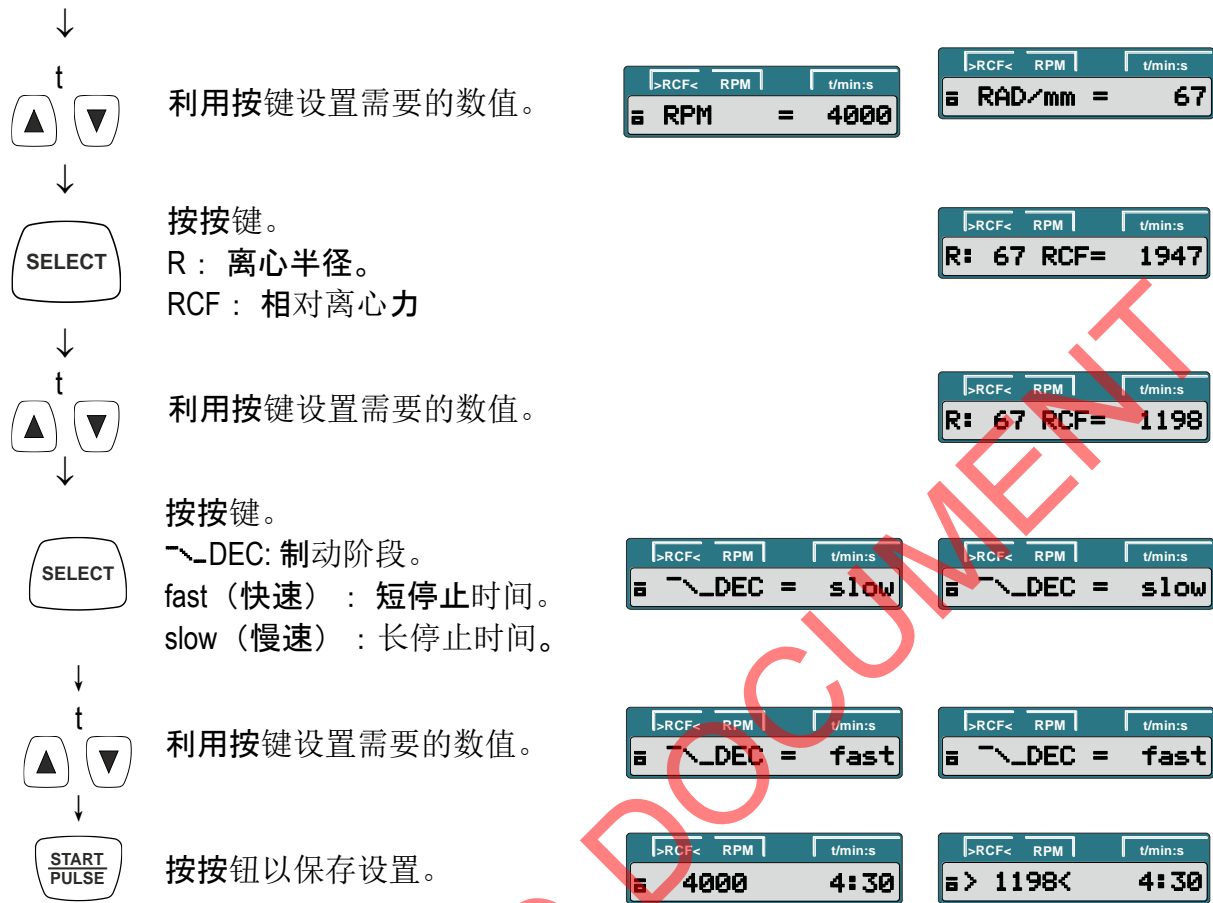
示例：

如果在转子负载范围内超过了允许的重量差，则在启动期间中止离心运行，并显示“IMBALANCE”。

示例：

通过按 键可以随时中止离心运行。

在离心运行期间，可以选择并更改离心参数。更改的数值仅应用于当前离心运行且不会被保存。利用 键，您可以随时在每分钟转数显示（RPM）和相对离心力显示（>RCF<）

之间切换。如果修改相对离心力显示 (>RCF<), 则必须输入离心半径。只有在打开机盖后才可能对离心机进行进一步操作。将显示操作错误和故障。

示例：

13.9 预设时间离心

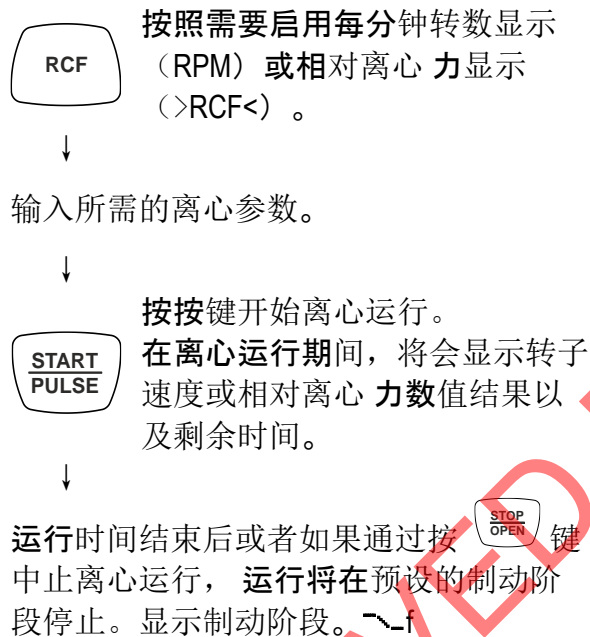

示例：
每分钟转数显示 (RPM)









示例：
相对离心力显示 (>RCF<)







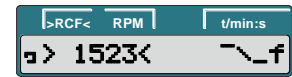

13.10 连续运行

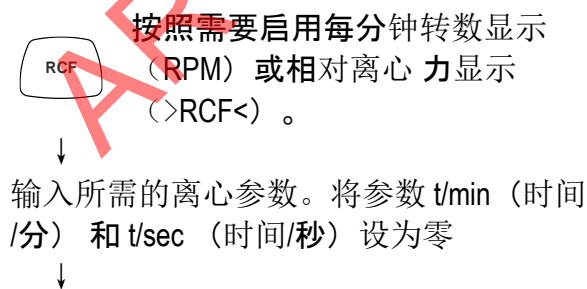

示例：
每分钟转数显示 (RPM)



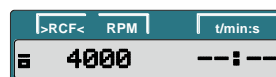

示例：
相对离心力显示 (>RCF<)

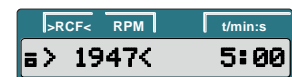

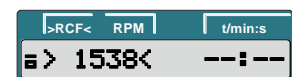

START PULSE
按按键开始离心运行。
在离心运行期间，将会显示转子速度或相对离心力数值结果以及运行时间。

>RCF<	RPM	t/min:s
4000		2:45

>RCF<	RPM	t/min:s
1538		2:45

STOP OPEN
按按键结束离心运行。
在设置的制动阶段停止运行。显示制动阶段。~f

>RCF<	RPM	t/min:s
3980		~f

>RCF<	RPM	t/min:s
1523		~f

13.11 短期离心设置

RCF
按照需要启用每分钟转数显示 (RPM) 或相对离心力显示 (>RCF<)。

示例：
每分钟转数显示 (RPM)

示例：
相对离心力显示 (>RCF<)

输入所需的离心参数（参阅“输入离心参数”一章）。

>RCF<	RPM	t/min:s
4500		5:00

>RCF<	RPM	t/min:s
1947		5:00

按下按键并一直按住。
在离心运行期间，将会显示转子速度或相对离心力数值结果以及运行时间。

>RCF<	RPM	t/min:s
4000		5:00

>RCF<	RPM	t/min:s
1538		5:00

START PULSE
再次松开按键结束离心运行。
在设置的制动阶段停止运行。显示制动阶段。~f

>RCF<	RPM	t/min:s
4000		0:24

>RCF<	RPM	t/min:s
1538		0:24

>RCF<	RPM	t/min:s
3980		~f

>RCF<	RPM	t/min:s
1523		~f

13.12 紧急制动

STOP OPEN
按按键两次。
在紧急制动期间，运行将在“fast（快速）”制动阶段（短停止时间）停止。将显示制动阶段。~f

示例：
每分钟转数显示 (RPM)

示例：
相对离心力显示 (>RCF<)

>RCF<	RPM	t/min:s
4270		~f

>RCF<	RPM	t/min:s
1753		~f

13.13 循环计数器

离心机装有循环计数器，会计算运行周期（离心运行）。在每次离心运行之后，当机盖解锁时，剩余的运行循环（循环运行）数会简要显示。

示例：

如果超出了允许的最大转子运行周期数，则当每次开始离心运行时将会显示以下信息，而且必须重启离心运行。为确保安全必须立刻更换新转子。在更换转子后，循环计数器必须重设为“0”。

示例：

13.14 将循环计数器重设为零

在更换转子后，循环计数器必须重新设置为零。仅在更换新转子后才需要将循环计数器重设为零。当转子停止时，循环计数器可按如下进行重设。通过按  键可以随时中止该过程。在该情况下，设置将不会保存。



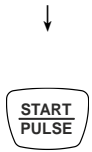

按按钮以保存设置。

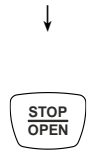
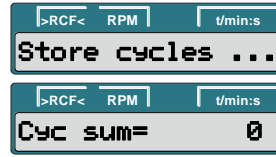

按键两次以退出 "-> Time & Cycles" (时间和循环) 菜单, 或按键三次以退出 "* MACHINE MENU (机器菜单) *"



示例 :



13.15 设置和查询

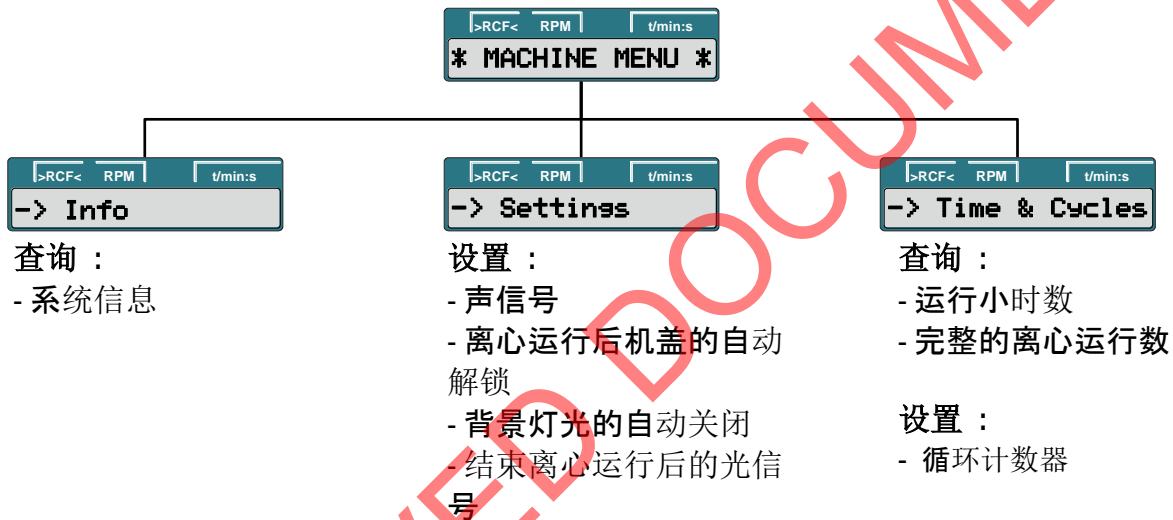

13.16 查询系统信息

可以查询以下系统信息:

- 设备型号;
- 设备的程序版本;
- 设备的型数;
- 设备制造日期;
- 设备序列号;
- 变频器类型;
- 变频器程序版本

当转子停止时, 查询可按如下方式进行: 通过按 键可以随时中止该过程。



按下并按住按钮 8 秒钟。



按按键。



按按键。
设备型号。

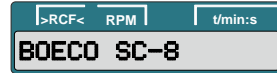

按按键。
设备的程序版本。

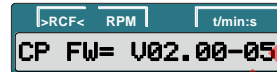

示例：



按按键。
Type#1 (型数 1)：设备的型数。



示例：



按按键。
Type#2 (型数 2)：如果位置超出
“Type#1”显示字段，型数继续。

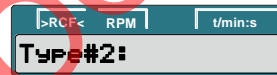

示例：



按按键。
设备制造日期。

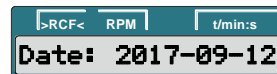

示例：



按按键。
设备序列号。



示例：



按按键。
变频器类型。



示例：



按按键。
变频器程序版本。



示例：



按键两次以退出 “-> Info (信息)” 菜
单，或按键三次以退出 “* MACHINE
MENU (机器菜单) *”。



示例：

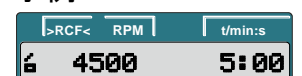

13.17 声信号

声信号的声音：(1) 故障发生后以 2 秒的间隔发声。(2) 离心运行结束及转子停止后，以 30 秒的时间间隔发声。按任意键均可终止声信号。如果转子处于静止状态，可按照以下方式设置声信号。通过按  键可以随时中止该过程。在该情况下，将不会保存设置。



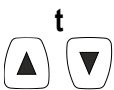

利用按键, 设置 min、mid 或 max。



按按钮以保存设置。



按键一次以退出 "-> Settings (设置)" 菜单, 或按键两次以退出 "* MACHINE MENU (机器菜单) *".



示例:

13.18 结束离心运行后的光信号

离心运行结束后背光显示将闪烁, 这是通过视觉信号表明离心运行已经结束。

当转子停止时, 可以开启或关闭光信号。通过按  键可以随时中止该过程。



按下并按住按钮八秒钟。



按下按钮直到显示以下内容。



按按钮。



按下按钮直到显示以下内容之一:
End blinking (结束闪光): 在离心运行后的显示背光闪烁。
off (关闭): 背光没有闪烁。
on (开启): 背光闪烁。



利用按键设置 off 或 on。



按按钮以保存设置。





按键一次以退出 "-> Settings (设置)" 菜单, 或按键两次以退出 "* MACHINE MENU (机器菜单) *".



示例 :



13.19 离心运行后机盖的自动解锁

可以设置在离心运行之后机盖是否可自动解锁。

当转子停止时, 这可按如下方式进行设置。通过按  键可以随时中止该过程。在该情况下, 设置将不会保存。



按下并按住按钮 8 秒钟。



按下按钮直到显示以下内容。



按按钮。



按下按钮直到显示以下之一：
Lid AutoOpen (机盖自动打开) : 在离心运行之后机盖的自动打开。
off (关闭) : 机盖不会自动解锁。
on (开启) : 机盖自动解锁。

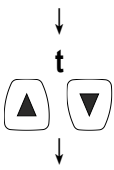

利用按钮设置 off 或 on。



按按钮以保存设置。



按键一次以退出 "-> Settings (设置)" 菜单, 或按键两次以退出 "* MACHINE MENU (机器菜单) *".



示例 :

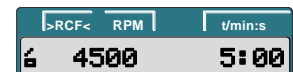

13.20 显示背光

为了节能，可以如下设置：离心运行结束后，显示背光在 2 分钟后关闭。当转子停止时，可按如下进行设置。通过按  键可以在任何时候中止此过程。在该情况下，设置将不会保存。

 按下并按住按钮八秒钟。

 按下按钮直到显示以下内容：

 按按钮。

按下按钮直到显示以下之一：











 **Power save (能量节约)**：背光的自动关闭。

- off (关闭)：禁用自动关闭。
- on (开启)：启用自动关闭。

 利用按钮设置 off 或 on。

 按按钮以保存设置。

 按键一次以退出 "-> Settings (设置)" 菜单，或按键两次以退出 "*MACHINE MENU (机器菜单)*"。

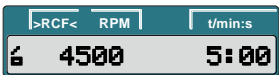

示例：

13.21 查询运行时间及离心运行次数

运行时间分为内部运行时间和外部运行时间。内部运行时间：设备开启的总时间。外部运行时间：上次离心运行的总时间。当转子停止时，查询可按如下方式进行。通过按  键可以在任何时候中止此过程。

 按下并按住按钮八秒钟。



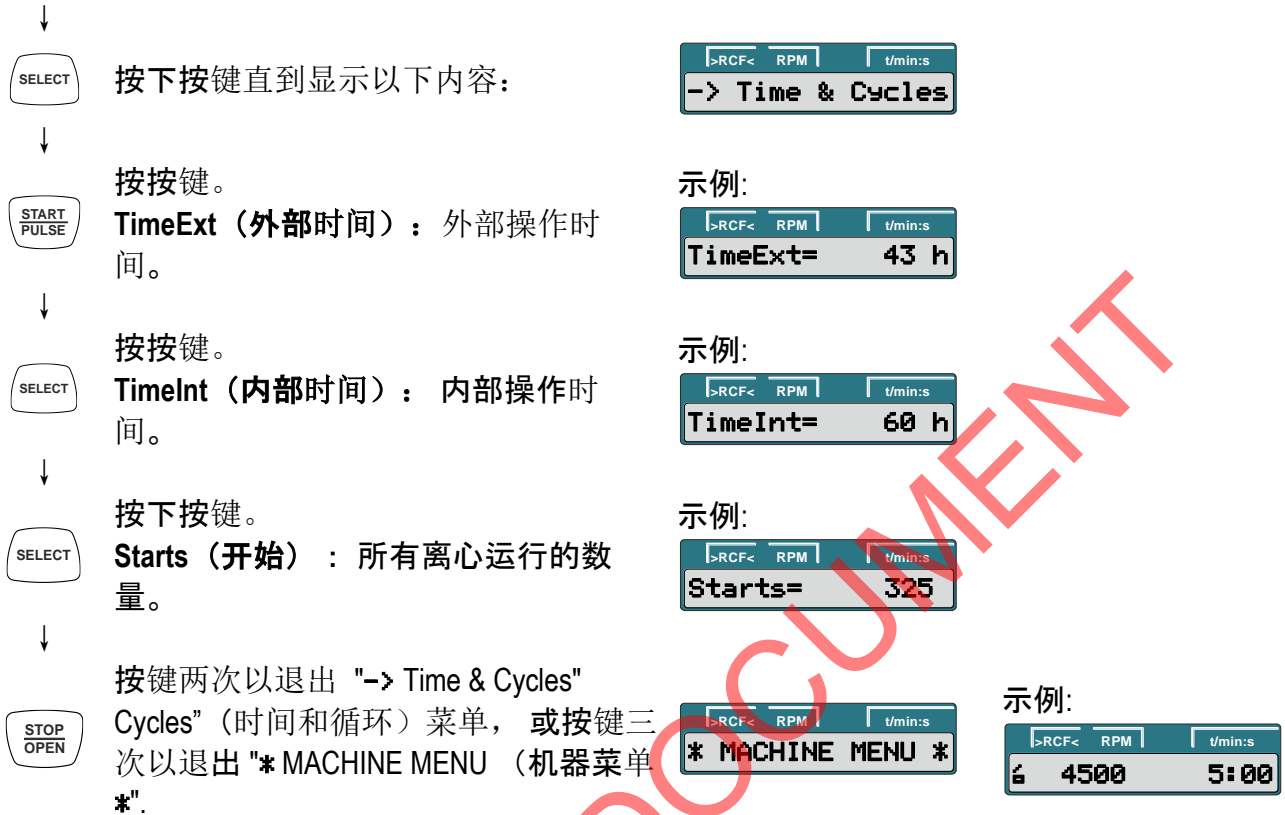

14 故障

如果无法使用下表中的故障表消除故障, 请联系客户服务并告知离心机的类型和序列号。两个数字都可以在离心机的铭牌上找到。

执行 MAINS RESET (主电源重置): 打开总电源开关 (转到位置“0”)。等待至少 10 秒钟, 然后再次打开主电源开关 (切换到位置“1”)。

信息/故障		原因	补救办法
无显示		无电压 主电源输入保险丝有问题。	<ul style="list-style-type: none"> - 检查配电电压。 - 检查电源输入保险丝, 并参考更换电源保险丝的说明。 - 主电源接通。
IMBALANCE (不平衡)		转子的负载不均衡。	<ul style="list-style-type: none"> - 在转子停止后打开机盖。 - 检查转子的负载 - 重复离心运行。
MAINS INTER (电源中断)	11	在离心运行过程中断电。(未完成离心运行。)	<ul style="list-style-type: none"> - 在转子停止后打开机盖。 - 按下 start/pause 按钮。 - 如有必要, 请重复离心运行。
MAINS INTERRUPT			

(电源中断)			
TACHO ERROR (转速计故障)	1, 2	运行中无速度脉冲。	- 当转子停止时, 进行 MAINS RESET。
LID ERROR (机盖出错)	4.1 - 4.127	机盖锁定或关闭出错。	
OVER SPEED (超速)	5	旋转过快	
VERSION ERROR (版本错误)	12	识别的离心机型号不正确。 电子设备故障/有缺陷	- 当转子停止时, 进行 MAINS RESET。
UNDER SPEED (速度不足)	13	旋转过慢	
CTRL ERROR (控制错误)	22.1, 25.2	电子设备故障/有缺陷	
CRC ERROR (循环冗余码校验错误)	27.1		
COM ERROR (通信端口错误)	31 - 36		
FC ERROR (变频器故障)	60, 61.1 - 61.21, 61.64 - 61.142	速度测量错误	
FC ERROR (变频器故障)	61.23		
TACHO ERROR (转速计故障)	61.22		
FC ERROR (变频器故障)	61.153	电子设备故障/有缺陷	- 进行 MAINS RESET。 - 按照提供的说明检查转子的负载。 - 重复离心运行。

15 相对离心力 (RCF)

相对离心力 (RCF) 以重力加速度 (g) 的倍数表示。它是一个没有单位的数值, 用于比较分离和沉降性能。相对离心力 (RCF) 与每分钟转数和离心半径相关。可以使用以下公式计算:

$$RCF = \left(\frac{RPM}{1000} \right)^2 \times r \times 1,118 \quad \Rightarrow \quad RPM = \sqrt{\frac{RCF}{r \times 1,118}} \times 1000$$

RCF = 相对离心力

RPM = 转速（每分钟转数）

r = 离心半径（单位：毫米）= 从旋转轴中心到离心机容器底部的距离。

16 运输和贮存

在运输此设备前，必须安装运输保护装置。设备和附件只能贮存在密闭且干燥的室内。运输或存放设备和配件时，必须符合以下条件：

环境温度：-20°C 到 60°C

相对湿度：10% 到 80%，不结露

17 更换主电源输入保险丝

首先关闭电源开关，然后将设备与电源分开。装有电源输入保险丝的保险丝座（A）位于电源开关旁。将连接电缆从机器插座上拔掉。按压保险丝座（A）的扣合（B），移除保险丝座。更换故障电源保险丝。只能使用制造商提供的离心机类型所定义额定值的保险丝。重新插入保险丝座，直到扣合咔哒一声锁定。将设备重新连接到电源。

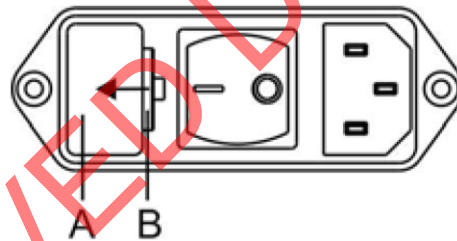

18 退回设备

在退回该设备前，必须安装运输保护装置。如果将设备或其配件退还给合法的制造商，则为了保护人员，环境和材料，必须在运输之前对其进行净化和清洁。合法制造商保留拒绝受污染的设备或配件的权利。由清洁和消毒而产生的费用将向客户收取。

19 弃置

在弃置之前，必须净化和清洁设备以保护人员、环境和财产。当您弃置该设备时，必须遵守相应的法律规则。依据指令 2002/96/EC（报废电子电气设备指令），所有在 2005 年 8 月 13 日之后供给客户的设备都不可作为生活垃圾弃置。此设备隶属于第 8 组（医疗设备），且被归类于企业对企业领域。打了叉的垃圾桶图标也显示该设备不可作为生活垃圾弃置。各个欧共体国家的废物处理准则可能有所不同。如有必要，请联系您的供应商。



下記の記号表は参考用です。適用記号については、製品の包装ラベルを参照してください。

シンボル	シンボル説明
	注意
	電子版取扱説明書
	製造元
	BioHorizonsはCEマークを取得しており、医療機器指令93/42/EECの要件を満たしています
	参照 / 商品番号
	ロット / バッチ番号
	再利用禁止
	再滅菌しないでください。
	使用期限
	ガンマ線照射による滅菌
	製造年月日
	注意：米国連邦法により、これらの機器の購入、流通および使用は、歯科医、医師、または歯科医、医師による発注のみに限られています。

シンボル	シンボル説明
	ホームポジション
	パッケージが破損している場合は、使用しないでください
	医療機器
	非滅菌
	水濡れ注意
	割れ物注意
	温度制限
	横積厳禁
	湿度制限
	警告;バイオハザード
	重要な注意事項
	電気および電子機器の分別収集。
	欧州連合の承認された正式な代表者

1 使用目的

IntraSpin システムは、治療現場において患者の少量の血液検体から自己多血小板フィブリン (L-PRF) を安全かつ迅速に調製するのに使用することを目的としています。それぞれ材料の特性を生かすために、骨欠損部への適用前に L-PRF を自己移植骨や同種移植骨と混合します。取扱説明書をすべてよくお読みになり、記載事項を遵守するようお願い致します。

2 禁忌

IntraSpin 遠心分離機は、デバイスの使用目的に記載されている事項のみに限ります。それ以外の使用は意図されていないと見なされます。IntraSpin 遠心分離機の使用は、患者様に次の臨床的状況が1つ以上存在する場合は禁忌です：アルコール依存症または精神疾患、血液異常症、コントロール不良の糖尿病、甲状腺機能亢進症、口腔感染症、悪性腫瘍、または12か月以内に心筋梗塞を起こした。AIDSなどの免疫系に支障をきたすような疾患のある。インプラント部位の治癒を損なう可能性のある薬物治療中である。過去に口腔衛生手順に従わない、不十分であったなど。

抗凝固療法を受けている患者様は PRF の禁忌から除外されますが、遠心分離機にかける時間を追加して、分離を充分にする必要があります。

3 安全に関する注記

- このマニュアルのすべての指示に従わない使用については、製造元による保証の対象外となります。
- 取扱説明書はデバイスの一部です。常にすぐに利用できるようにしておかなければなりません。デバイスが別の場所に設置されている場合は、操作説明書も一緒に提供する必要があります。
- 遠心分離機は十分に安定した台の上に設置する必要があります。
- 遠心分離機を使用する前に、しっかりと配置されているかどうかローターを確実にチェックしてください。

- EN / IEC 61010-2-020 では、遠心分離機周辺は 30 cm 以上離すようにしてください。遠心機に事故が発生したときに二次災害や周囲の危機の破損を防ぐためです
- ローター、サスペンションや付属品に微量の腐食や機械的損傷がある場合、または使用期限が切れている場合は、使用できません。
- 遠心分離室に安全性にかかるとの損傷がある場合も、使用には適しません。
- 室温管理ができない状況での遠心分離機の使用は、室温が上昇したときや装置が頻繁に使用されたときにまたは両者が同時に起った時に遠心分離室の室温が上昇した場合、試料が変性する可能性があります。
- 遠心分離機を初めて使用する前に操作マニュアルをよく読み、操作手順を十分に理解してください。操作マニュアルを読んで理解した人のみが装置を操作するようにしてください。
- 操作マニュアルおよび事故防止に関する法的規制に加えて、安全で専門的な方法で操作できるよう、認められた専門規制にも従う必要があります。本操作マニュアルは、装置を使用する国の国内規則に基づく、事故防止および環境保護に関するその他の指示と併せてお読みください。
- 遠心分離機の使用を目的とする作業場においてこの装置の使用にかかわる労働安全上の国特有の要件を満たすことは、使用者の責任です。
- 本遠心分離機は操作が非常に安全な最先端の装置です。ただし、訓練を受けていない人が不適切な方法もしくは所定外の目的で使用した場合には、本人または他の人に危険をもたらす可能性があります。
- 遠心分離機は作動中に動かしたり衝撃を与えたりしてはなりません。
- 故障あるいは緊急解除の際には、回転を停止するまでローターには絶対に触れないでください。
- 凝縮液による損傷を避けるため、寒い部屋から暖かい部屋に移す際は、遠心分離機を本線に接続する前に暖かい部屋に少なくとも 3 時間置いて常温に上げるか、冷たい部屋で 30 分稼働させる必要があります。
- 毎分最大回転数で遠心分離させる場合、材料または材料混合物の密度は 1.2 kg/dm³ を超えてはなりません。
- 遠心分離機はバランスが許容範囲内である場合にのみ稼働できます。
- 遠心分離機は爆発の危険のある領域では稼働できません。

- 遠心分離機は決して以下に対し使用しないでください：可燃性または爆発性物質互いに反応して莫大なエネルギーを生じる物質。
- この遠心分離機にはバイオセーフティシステムはありません。
- ローター、ハンガー、付属品の機械的完全性を損なう可能性のある高腐食性物質を遠心分離機で扱ってはなりません。
- 修理を実行できるのは製造元から認可された担当者のみです。
- 患者に最高レベルの臨床的安全性を供与するため、Intra-Lock 製品はヒト血漿と検体適合性のある材料で作成されています。
- 本製品は、地域によっては販売許可を得ていないため、お住まいの地域では入手できない場合もあります。詳細は、最寄りの Intra-Lock 代理店にご相談ください。

4 INTRASPIN システムコンポーネント

部品	数量
IntraSpin 遠心分離機:	1
電力ケーブル	1
ヒューズ	2
六角ハンドレンチ	1
Greiner 採血チューブとバランシングチューブ (単回使用)	150
グライナーセーフティブラッドコレクションセット+ホルダー、21G (使い捨て)	24
ラテックスフリー止血帯	1
試験管立て	1
外科用湾曲はさみ	1
外科用組織鉗子	1
ラウンドステンレススチールボウル	1
長方形のステンレス鋼ボウル	1
二重生体材料担体へら	1
デュアル生体材料パッカー	1
Xpression® ボックス	1

IntraSpin 遠心分離機で直接使用できる検証済みの互換性のあるコンポーネントのみが推奨され、保証されています:

互換パーツ	説明
455092	チューブ 9ml CAT セラムクロットアクティベーター、赤いキャップ
455001	ホワイトキャップ 9mlZ 無添加チューブ
BHEXZ (E613)	IntraSpin 六角キー、110v および 220v
BROTORZ (E3694)	IntraSpin ローター、100v&220v
BPOWER110Z (E1673)	IntraSpin 電源コード、110v
BPOWER220Z (E1669)	IntraSpin 電源コード、220v
BTUBEHOLDZ (E872 x 1)	IntraSpin チューブホルダーの交換
BFUSE110Z (E997)	IntraSpin ヒューズ 110v
BFUSE220Z (E891)	IntraSpin ヒューズ 220v

5 遠心分離のセットアップの概要

遠心分離機の底から輸送ボルトを取り外して保管します。

AC ケーブルを接続し、コンセントに差し込みます。

デバイスの背面にあるロッカースイッチを使用して、遠心分離機の電源を入れます。

速度と時間を選択: 速度 = 2700 と時間 = 12:00 分 00 秒

START (開始) ボタンを押します。

各サイクル終了時に、遠心分離機のカバーが自動的に開きます。

最初の手順の後、設定を変更しない限り、タイミングと速度は遠心分離機のメモリに記憶されます。

6 採血チューブと採血セットの注意と指示

- 異物がある場合はチューブを使用しないでください。
- 採血チューブは完全に充填できなければなりません。
- すべての生体試料と採血用「シャープス」（針、採血セットなど）は、施設のポリシーと手順に従って処理します。
- 針を曲げないでください。
- 針安全機構が作動した後は、無理に解除したり、再度作動させたりしないでください。
- HIV（AIDS）、ウイルス性肝炎、またはその他の感染症の感染の可能性があるために、針刺し事故などによる生体試料への曝露があった場合、適切な医療処置を受けてください。
- 採血に使用された注射針等は承認されたバイオハザードコンテナに廃棄してください。
- サンプルをシリンジからチューブに移すことはお勧めできません。
- 静脈内（IV）ラインを介して採血する場合は、施設のポリシーと手順に従って、採血管への充填を開始する前にラインから IV 溶液が除去されていることを確認してください。
- 血液凝固促進剤は、チューブの表面に白く見える場合がありますが、チューブの性能には影響しません。チューブに他の変色や沈殿物がある場合は、使用しないでください。
- 有効期限を過ぎたチューブは使用しないでください。
- 採血チューブは 4~25° C (40~77° F) で保管してください。
- 採血セット（針とホルダー）は 4~36° C (40~97° F) で保管します。
- 直射日光を避けてください。最大推奨保管温度を超えると、チューブの品質が損なわれる可能性があります（真空の損失、着色など）。
- 逆流を防ぐには、患者様の腕を下向きにし、キャップを上にしてチューブを持ち、血液がチューブに流れ始めたらすぐに止血帯を解放し、静脈穿刺中にチューブの内容物がキャップまたは針の端に接触しないようにします。
- 静脈穿刺を実行する前に、次の材料にすぐにアクセスできることを確認してください：必要なすべての採血管、サンプルの患者を確実に識別するための識別されたラベル、採血針とホルダー、穿刺部位を洗浄するためのアルコール綿棒、清潔

なガーゼ、止血帯、絆創膏または包帯、承認されたバイオハザード容器。血液由来の病原体への曝露から保護するために、適切な PPE（個人用保護具）が推奨されます（例：手袋、実験室用コート、ゴーグルなど）。

静脈穿刺法と血液サンプル採取:

採血管には抗凝固剤がないため、採血はできるだけ早く行う必要があります。血液サンプルはすぐに凝固し始めます。静脈穿刺時および採血管の取り扱い時には手袋を着用して、暴露の危険を最小限に抑えます。採血の前に、選択した消毒用ワイプで血液チューブキャップの上部を拭いてください。ニードルのバルブセクションのカバーを取り外します。適切な防腐剤で静脈穿刺部位を準備します。クレンジング後に静脈穿刺部分を触らないでください。患者様の腕を下向きに置きます。ニードルシールドを取り外します。腕を下にしてチューブキャップを一番上にして静脈穿刺を行います。必要に応じて、針をテープで固定します。採血管をホルダーに挿入し、採血管のゴム製ダイヤフラムに穴を開けるニードルバルブに押し込みます。キャップを貫通するときに採血管をホルダーの中心に置き、側壁の貫通とその後の早期の真空損失を防ぎます。採血管に血液が入ったらすぐに止血帯を外してください。手順の間、親指でそれを押して、常にコレクションチューブを所定の位置に保持します。これは完全な真空引きを保証します。採血管が自動的に一杯になります。コレクションチューブに血液が流れない場合、または適切な検体が収集される前に血流が停止した場合は、満足のいく収集を完了するために次の手順が推奨されます。

- 採血管を前方に押して、キャップが貫通していることを確認します。
- 静脈内の針の正しい位置を確認します。
- それでも血液が流れない場合は、コレクションチューブを取り外して適切に廃棄します。新しいコレクションチューブを入手し、ホルダーに押し込みます。
- 2 番目のコレクションチューブが引き出されない場合は、針とコレクションチューブを取り外し、適切に廃棄します。手順を繰り返します。
- 採血管の最大充填ラインに達したら、ホルダーからそっと取り外します。2 番目の採血管で繰り返します。

ホルダーから取り外したらすぐに各コレクションチューブを静かに反転させます。血液サンプルで満たされたチューブを振らないでください。激しく混合すると、泡立ち

や溶血を引き起こすことがあります。血清チューブでの混合が不十分または混合が遅れると、凝固が遅れる可能性があります。

採血が完了したら、静脈から針を取り外します。ハブの両側を押し込んで針の安全機構（安全シールド）を作動させ、ロックをかけます。カチッという音が聞こえるまで、安全機構を後方にスライドさせます。針刺し傷や血液への暴露リスクが高まるため、針のキャップを付け直さないでください。使用済みの針は、適切なバイオハザード処理容器を使用してホルダーとともに廃棄してください。出血が止まるまで、乾いた滅菌綿棒で穿刺部位に圧力を加えます。必要に応じて、凝固が起こったら包帯を巻いてください。充填済みのコレクションチューブは、直立した状態で保管することをお勧めします。2番目の採血管がいっぱいになったら、それを取り外し、遠心機の反対側の位置に1番目と2番目のチューブを配置して、ローターのバランスを調整します。IntraSpin 遠心機のカバーを閉じ、START ボタンを押して12分間回転させます。

3本以上の血液チューブが必要な場合は、次の代替手順に従ってください。最初の2本に採血して静かに反転させた後、すぐに IntraSpin 遠心分離機の互いに反対側に置き、遠心分離機のバランスが適切に保たれるように調整します。カバーを閉じ、START ボタンを押して、残りの血液チューブを採取しながら遠心分離機を作動させます。STOP ボタンを押して、遠心機を完全に停止させます。カバーが飛び出します。残りのチューブをすぐに反対側の遠心機に入れ、適切なバランスを確保し、START ボタンを押してリセットして推奨プロトコルを完了します。
：遠心分離機のローターが釣り合うよう、常に管をペアにして相対する位置に置いてください。TART（開始）ボタンを押す前に、必ずローター内の管が釣り合っていることを確認してください。

遠心分離する血液サンプルの数が奇数の場合は、フルラインまで水で満たされた白いキャップのバランシングチューブ（例えば 455001）を、対になるようにローター内に配置します。こうすることで、遠心分離機がうまく釣り合います。血液検体の採取後すぐに遠心分離を開始します。遅延は血液分離手順に影響を与え、L-PRF フィブリン血餅の質を低下させます。

7 L-PRFでの調製

遠心分離後、3つのセグメントが見えます。

1. 上部セグメント = 血小板乏血漿 (PPP)。
2. 中間セグメント = フィブリン凝塊: L-PRF®。
3. 下部セグメント = 赤血球の凝塊。

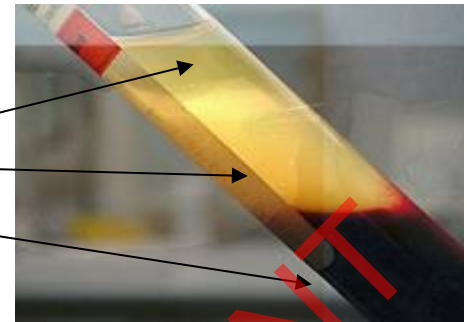

L-PRF フィブリンメンブレンまたはプラグは、遠心分離後 15 分経過すると、トラップされた血清が放出されて血餅の体積が減少するので、15 分以内に準備する必要があります。遠心後、各チューブからゴム栓を外します。外科用組織鉗子を使用して、チューブから L-PRF 血餅を除去します。L-PRF クロットに付着する赤血球の量が最小限になるように、デュアル生体材料キャリアスパチュラを使用して、ユニオンのすぐ下の L-PRF® フィブリンクロットから赤血球クロットをそっとこすり落とします。Xpression の穴のあいたトレイにフィブリン塊を置きます。

8 フィブリンマトリックスの準備

プロトコル 1 L-PRF メンブレン

各フィブリン塊を Xpression の穴のあいたトレイに置きます。すべてのフィブリン塊が配置されたら、Xpress 圧縮プレートと Xpression 加重カバーを血栓に圧力をかけずにフィブリン塊に配置します。

浸出液がトレイの底に濾過される間、カバーの重量がフィブリン塊をゆっくりと押し下げます。加重カバーに圧力をかけないでください。加重カバーにかかる重力により、血餅が穏やかに圧縮され、フィブリンネットワークに損傷を与えることなく、L-PRF 血餅から血清が分離されます。

フィブリンメンブレンを取り外して使用する前に、少なくとも 5 分間待ちます。実際の使用時までフィブリンメンブレンを取り外さないでください。フィブリンメンブレンは、最長 3 時間、Xpression ボックスに置いておくことが可能です。



プロトコル 2 L-PRF プラグ

白いプラグ製作シリンダーの内側にフィブリン塊を置きます。ピストンを使用して、白い L-PRF プラグ製造シリンダー内の血餅をゆっくりと押し下ろします。ピストンの上端が白い L-PRF プラグ製作シリンダーの上端と面一になるまで押し続けます。この技術を使用すると、抽出ソケット用の厚く丸いフィブリンプラグを形成できます。単一の歯の場合、L-PRF プラグは 1 つで十分です。抜歯ソケットのサイズと作成されたフィブリン塊のサイズによっては、大白歯には 2 つの L-PRF プラグが必要で、大白歯には 3 つの L-PRF プラグが必要になる場合があります。

L-PRF® の加工性により、好みのバイオマテリアルと組み合わせて使用する優れた媒体が提供されます。下記の混合プロトコルのうちいずれかを利用して、バイオマテリアルをフィブリン基質に捕獲させて取り扱いおよびバイオリジック・キャパシティを増加させます。

プロトコル 3- バイオマテリアル/L-PRF 混合物

バイオマテリアル器具でやさしく希望する形状と厚みに形成できる「パテ状」混合物を作成するには、下記のプロトコルを使用します。外科用湾曲ハサミを使用して、L-PRF フィブリンメンブレンを無菌皿の中で細かく細かく切ります。希望する量の骨移植材料を追加します。L-PRF® と骨移植材料をしっかりと混ぜます。この混合物は、二重の生体材料担体へらを使用して欠陥に配置することができます。



プロトコル4- バイオマテリアル/L-PRF 基質混合物

所定量の骨移植材料を滅菌ボールまたはトレーに入れます。発現した L-PRF メンブレンまたは L-PRF メンブレンの破片を、L-PRF メンブレンの表面積全体をグラフト材料で覆うグラフト材料に浸します。あるいは、グラフト材料を、全表面積をグラフト材料で覆う L-PRF 膜上に振りかけることができる。注：湿った L-PRF メンブレンは、乾燥した L-PRF メンブレンよりもわずかに多くのグラフト材料を保持する場合があります。グラフト材料は L-PRF の表面に付着する必要がありますが、必要に応じて、グラフト材料を L-PRF 膜に優しく押し付けます。外科組織鉗子を使用して、この混合物を欠損部に配置できます。

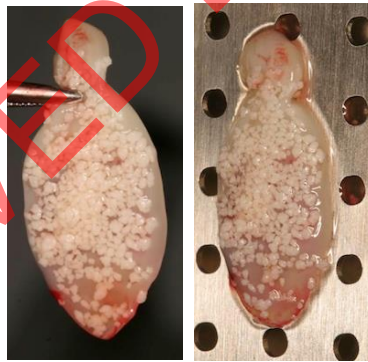

プロトコル5 - 生体材料の水和

必要な量の骨移植片材料を滅菌ボウルまたはトレーに追加します。Xpression 収集トレイの底部からの浸出液を利用して、グラフト材料を水和させます。浸出液と骨移植片材料を完全に混合します。この混合物は、二重の生体材料担体へらを使用して欠陥に配置することができます。

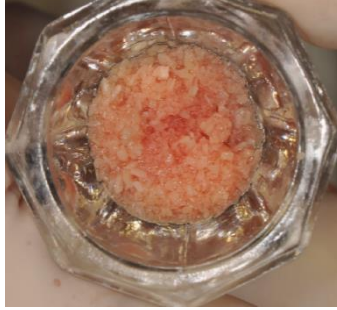

9 組織再生キットの洗浄と滅菌

Xpression ボックスを使用すると、一定の厚さのフィブリン膜を簡単に作成できます。浸出液は、Xpression 穴あきトレイの下にある Xpression 収集トレイから収集できます。Xpression ボックスには、L-PRF プラグ製造シリンダーと、ポスト抽出ソケットに簡単に適合する L-PRF プラグを製造するためのピストンが含まれています。



Xpression 加重カバー



Xpression 圧縮プレート



Xpression Collection トレイ
の Xpression 穴あきトレイ

Xpression ボックスと付属機器は無菌状態では提供されません。最初の滅菌の前に、輸送資材をすべて取り除いて廃棄してください。使用する前に、Xpression ボックスと付属機器を洗浄および滅菌してください。

各洗浄および滅菌サイクルの前に Xpression ボックスを分解して、破片のカプセル化、材料の変色、および/またはコンポーネントの不適切な乾燥を回避します。L-PRF プラグ製作シリンダーとピストングロメットは、洗浄と滅菌のために Xpression の穴あきトレイから取り外すことはできません。

洗浄: (1) 柔らかい毛のブラシと、Hu-Friedy'sEnzymax®または同等品などの広域スペクトルの洗浄剤または消毒剤を使用して、Xpression ボックスコンポーネントおよび補助器具から目に見える破片を取り除きます。よくすすいでください。(2) Xpression ボックスのコンポーネントと付属機器を適切なサイズの同じ溶液の容器に入れ、10 分間超音波処理します。よくすすいでください。(3) Xpression ボックスのコンポーネントと付属機器をイソプロピルアルコールですすぎ、石鹼の残留物とミネラルをすべて取り除きます。(4) 糸くずの出ないタオルで Xpression ボックスのコンポーネントと付属機器をふき取り、完全に風乾します。使用方法については、使用する洗浄剤のラベルを参照してください。

滅菌: (1) 組み立て直した Xpression ボックスと付属機器を FDA 承認済みの滅菌バッグまたはラップに入れます。(2) 以下の認定された滅菌サイクルのいずれかを実行します。

滅菌方法	温度	曝露時間	最短乾燥時間
事前真空蒸気 (ANSI/AAMI ST79)	132° C (270 ° F)	4 分	20-30 分
事前真空蒸気 (UK DoH Health Technical Memorandum 01-01)	134° C (273 ° F)	3 分	20-30 分

注意! 不適切な洗浄は、不十分な滅菌につながる可能性があります。オートクレーブ中に Xpression ボックスのコンポーネントと付属機器を完全に乾燥させないと、湿気が残り、変色や酸化を引き起こす可能性があります。過酸化水素または他の酸化剤を使用すると、Xpression Box コンポーネントおよび付属機器の表面が損傷します。ユニットが適切に機能する状態を保つためにはオートクレーブ装置の定期的なテスト、クリーニング、およびキャリブレーションを推奨します。

10 遠心分離機のクリーニングとメンテナンス

装置は汚染されている可能性があります。クリーニング前に電源プラグを外してください。遠心分離機、ローターおよび付属品は、機械洗浄しないでください。これらは手洗いで洗浄し、液体消毒のみが可能です。20 ~ 25° C の水温で洗浄してください。また洗浄剤/消毒液は pH 5~8 で、苛性アルカリ、過酸化剤、塩素化合物、酸、アルカリ溶液を

含まないもののみ使用してください。洗浄剤や消毒剤による腐食を防ぐために、洗浄剤または消毒剤の製造元からの適用上の注意厳守して使用してください。

不純物の付着による腐食を防ぐために、必要に応じて石鹼または中性洗剤と湿らせた布を使用して、遠心機室と遠心分離チャンバーを定期的に清掃します。適切な洗剤の成分には、石鹼、陰イオン界面活性剤および非イオン界面活性剤が含まれるものを使用してください。洗剤使用後は、湿った布で拭いて洗剤の残留物を取り除きます。クリーニング後は直ちに表面を乾かしてください。結露水が生じた場合は吸収性のある布で拭き取って遠心分離室を乾かしてください。クリーニングのたびに、遠心分離室のゴム製シールをタルカムパウダーまたはゴム用ケア製品でやさしくこすります。遠心分離チャンバーに損傷がないかチェックします。安全性に関わる損傷が見つかった場合、遠心分離機の使用を中止し、カスタマーサービスまでご連絡ください。

表面消毒には感染性物質が遠心分離室に浸透した場合、直ちに消毒してください。エタノール、n-プロパノール、エチルヘキサノール、陰イオン界面活性剤および腐食防止剤が含まれる消毒液を使用してください。消毒剤使用後は、湿った布で拭いて消毒剤の残留物を取り除きます。消毒後は直ちに表面を乾かしてください。

放射性汚染物質の除去のために薬剤は、放射性汚染物質除去のための薬剤であることが明確に表示されているものでなければなりません。陰イオン界面活性剤、非イオン界面活性剤、多水和エタノールが含まれる薬剤を使用してください。放射性汚染物質除去後は、湿った布で拭き取って残留薬剤を除去します。放射性汚染物質除去後は直ちに表面を乾かしてください。

11 ローターと付属品 クリーニングとメンテナンス

腐食や材料の変化を防ぐために、ローターと付属品は必ず石鹼または中性洗剤と湿った布を使って定期的にクリーニングしてください。クリーニングは少なくとも週に一度が推奨されます。汚染は直ちに除去しなければなりません。

、石鹼、陰イオン界面活性剤および非イオン界面活性剤が含まれる洗剤を使用してください。洗剤使用後は、（遠心分離機の外側のみを）水ですすぐか、湿らせた布で拭いて洗剤残留物を除去します。ローターと付属品は、クリーニング後直ちに乾かしてください。摩耗や腐食による損傷がないか、ローターと付属品を毎週点検してください。ローターと付属品は、摩耗や腐食の兆候が見られたら使用を中止してください。ローターが

しっかり着座しているかを毎週定期的に確認してください。感染性物質がローターや付属品に付着したら、速やかに適切な薬剤を使用して消毒してください。

エタノール、n-プロパノール、エチルヘキサノール、陰イオン界面活性剤および腐食防止剤を含む消毒剤を使用してください。消毒剤使用後は、（遠心分離機の外側のみを）水ですすぐか、湿らせた布で拭いて消毒剤残留物を除去します。ローターと付属品は消毒後直ちに乾かしてください。

放射性汚染物質の除去のために、薬剤は、放射性汚染物質除去のための薬剤であることが明確に表示されているものでなければなりません。放射性汚染物質を除去するための適切な薬剤は、陰イオン界面活性剤、非イオン界面活性剤および多水和エタノールが含まれるものを使用してください。後放射性汚染物質除去後は、（遠心分離機の外側のみを）水ですすぐか、湿らせた布で拭いて薬剤残留物を除去します。ローターと付属品は放射性汚染物質除去後直ちに乾かしてください。

ローターを 121oC / 250oF で 20 分間オートクレーブし、適切に乾燥させます。オートクレーブ 10 サイクル後には、安全上の理由からローターを交換しなければなりません。オートクレーブ処理はプラスチックの劣化プロセスを加速させ、変色を引き起こす可能性があります。オートクレーブ後、ローターが周囲温度に冷めるまで待ってから、再度使用してください。滅菌の程度については明言できません。

ローターの使用期間は、50,000 回の運転サイクル（遠心分離運転）または 5 年のいずれか早い方に制限されます。最大許容作動サイクル数は、ローターに記載されています。安全上の理由から、（ローター本体に記載された）最大許容作動サイクル数に達するとそのローターは使用できなくなります。本装置には実行中のサイクル（遠心分離実行）をカウントするサイクルカウンターが装備されています。

血液チューブが破損した場合、破損したパーツと血液サンプルはすべて完全に除去してください。遠心機は指示どおりに完全に洗浄し、ローターのゴム製インサートとプラスチック製スリーブを交換する必要があります。

12 遠心機仕様

モデルタイプ	IS220Z	IS110Z
電源電圧 (± 10%)	200 - 240 V 1~	100 - 127 V 1~
電源周波数	50 - 60 Hz-	50 - 60 Hz
接続負荷	100 VA	100 VA
電流消費	0.5 A	1.0 A
容量	8 x 10 ml	
最大許容密度	1.2 kg/dm ³	
最大速度 (RPM)	6,000	
相対遠心力 (RCF)	3,461	
運動エネルギー	750 Nm	
設置場所	屋内のみ	
高度	海拔 2,000 m 以下	
動作時の周囲温度	5° C ~ 40° C	
操作のための相対湿度	31° C までの温度では最高相対湿度 80%、40° C では相対湿度 50% まで段階的に減少	
過剰電圧カテゴリー	II	
汚染度	2	
装置保護等級	I	
	爆発の危険にさらされている領域での使用には適しません。	
放出干渉、干渉耐性	EN / IEC 61326-1, クラ	FCC クラス B
騒音レベル (ローターに依存)	≤ 50 dB(A)	
遠心分離機の幅	261 mm	
遠心分離機の深さ	353 mm	
遠心分離機の高さ	228 mm	
遠心分離機の重量	約 9 kg	

13 CENTRIFUGE の使用方法

2(a) 本のネジと 2 (b)つのスペーサーで構成される輸送用固定装置を取り外すことが不可欠です。装置を移動する場合に必ず取り付けなければならないため、移動用固定具は安全な場所に保管しておいてください。装置を移動するには必ず移動用固定具を取り付けなければならない。移動による損傷から装置を保護するため、モーターは定位置に固定されています。この移動用固定具は、装置を作動させる際には取り外さなければならない。

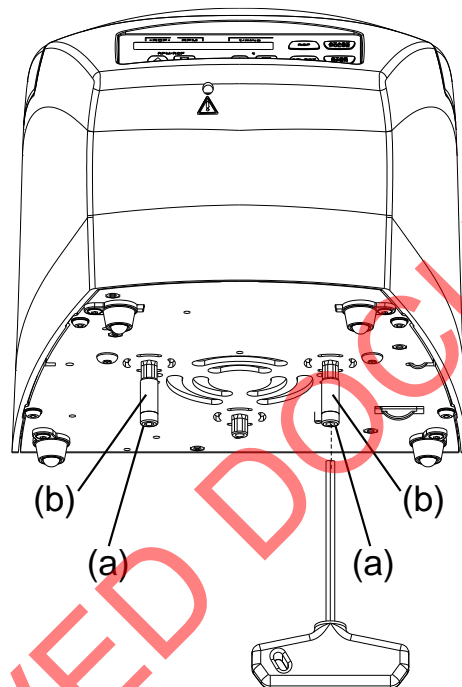

13.1 初期操作

- 輸送用固定装置を遠心機の底面から取り外します。
- 遠心分離機を適切な場所に安定させて水平に置きます。遠心分離機が作動しているときは、人、危険物、または物体が遠心分離機の周囲 30 cm の安全マージン内にならないようにしてください。
- 換気口はブロックされていない場合があります。換気スロットと遠心分離機の開口部から 30 cm の間隔を維持しなければなりません。
- 電源電圧が銘板に記載されている値と一致するかを確認してください。
- 遠心分離機を電源コードで通常のコンセントに接続します。
- 電源スイッチをオンにします。

- パネルには、遠心分離機のモデルタイプ、ソフトウェアのバージョン、最後に使用した遠心分離データが表示されます。
- 蓋が閉じている場合、「Open the lid (蓋を開ける)」というメッセージが表示されます。その場合、蓋を開けると遠心分離データが表示されます。

13.2 CENTRIFUGE 蓋の開閉

遠心分離機のスイッチが入っていてローターが静止している場合にのみ蓋を開けることができます。サイクルカウンタが有効になっている場合、遠心分離終了後に蓋を開けると残りの作動サイクル数（遠心分離回数）が短い間表示されます。

例：

蓋を開くには、次のキーを押します 。蓋がモーターによりロック解除されます。蓋がロック解除されていることを示します。

例：

蓋とハウジングの間に指を入れないでください。蓋を乱暴に閉じないでください。蓋を閉じるには、蓋の前端を軽く押し下げます。蓋がロックされていることを示します。

例：

13.3 緊急時のロック解除

停電の場合、モーターで蓋をロック解除することができません。緊急時ロック解除は手で行わなければなりません。緊急時にロックを解除する場合は、電源スイッチをオフにします（スイッチを「0」に設定）。蓋にある窓から、ローターが静止していることを確認します。ローターが静止するまで蓋を開けないでくださいアレンキーを穴 (A) に水平に挿入し、蓋が開くまで慎重に反時計回り（左）に回します。注意！六角アレンキー

を時計回り（右）に回すと、ロックシステムが損傷する可能性がありますアレンキーを穴から引き出します。

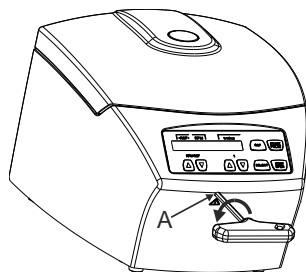

13.4 ローターの取り付けと取り外し

ローターを取り外すには、アレンレンチ（付属品）でローターのクランピングナットを反時計方向に回して緩め、吊り上げ圧力ポイントまで上に上げます。上昇圧力点を超えた後は、ローターはモーターシャフトの円錐から外れます。ローターがモーターシャフトから持ち上がるまで、クランプナットを回します。モーターシャフトからローターを持ち上げます。

ローターを取り付けるには、モーターシャフト (A) とローターの穴を掃除してからモーターシャフトにグリースを薄く塗ります。モーターシャフトとローターの間にごみの粒子があると、ローターの着座が不完全となり回転が不安定になります。ローターをモーターシャフトに垂直に置きます。ローターを装着するとき、ローターのマーキングビーム (B) はモーターシャフトの両面 (C) と平行でなければなりません。アレンレンチ（付属品）でローターのクランピングナットを時計方向に回して締めます。ローターがしっかりと取り付けられていることを確認してください。

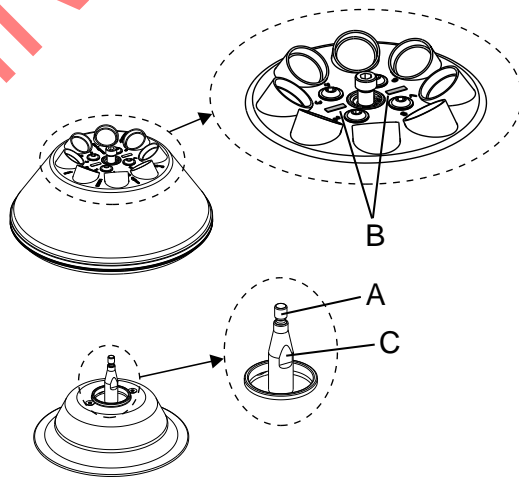

ローターは左右対称に装填しなければなりません。血液チューブは、ローターのすべての位置に均等に配置する必要があります。

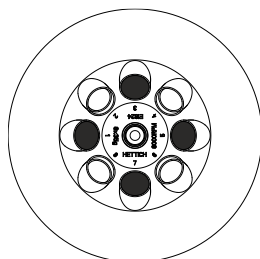

均等に装填されたローター

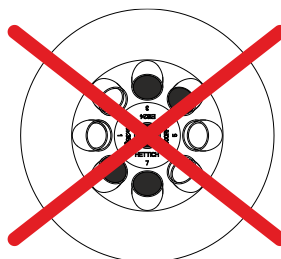

ローターの装填が不均等
使用できません!

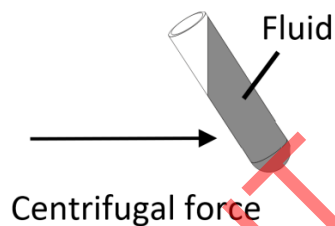

血液チューブは、遠心分離機の外でのみ充填できます。血液チューブの最大充填量はチューブ自体に指定されており、ローターに記載されている最大重量を超えてはなりません。遠心分離機容器を充填できるのは、装置の作動中に容器から液体が放出されないレベルまでのみです。ローターを装填する際、ローターまたは遠心分離室に液体を混入させてはなりません。遠心分離容器内の重量差をできる限り最小限に維持するために、血液チューブの一定の充填レベルが推奨されます。

ARCHIVED DOCUMENT

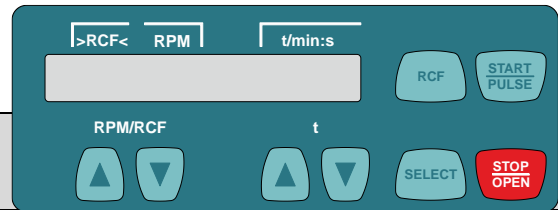

13.5 ディスプレイ表示、ボタンの説明



シンボル/ パネルキー	表示内容
	蓋ロックオフ（解除）。
	蓋ロックオン（固定）。
	回転表示。ローターが回転している間は回転表示が点灯し、ローターが回転しているとき。
	速度を直接入力できます。 キーを押し続けると、値がより速く変わります。
	実行時間を直接入力できます。1分以内の場合は1秒ごとに、1分を超える場合には1分ごとに調整できます。 遠心分離パラメータを入力できます。キーを押し続けると、値がより速く変わります。
	個々のパラメータをアクティブ化します。キーを押すごとに、次のパラメータが有効になります。 キーを8秒間押し続けると、「MACHINE MENU」（マシンメニュー）が呼び出されます。[Machine Menu] 内で [Info（情報）]、[Settings（設定）]、[Time & Cycles（時間 & サイクル）] メニューを選択します。 ・メニュー内をスクロールして進みます。
	速度表示（RPM）と相対遠心力表示（>RCF<）を切り替える。 RCF 値は、矢印> <の間に表示されます。
	遠心分離を開始できます。短期遠心分離。 キーが押されている限り、遠心分離が実行されます。メニューを選択するには [->Info], [->Settings] そして [->Time & Cycles]
	遠心分離を終了します。 ローターはあらかじめ選択されているブレーキ段階で徐々に停止します。 キーを2回押すと緊急停止が作動します。蓋のロックを解除できます。
t/min (時間 / 分)	作動時間。1～99分の間で、1分ごとに調整可能。
t/sec	作動時間。1～59秒の間で、1秒ごとに調整可能。

(時間 / 秒)	継続作動「--:--」。パラメータ [t/min] と [t/sec] をゼロに設定します。
RPM	速度。200 rpm からローターの最高速度までの数値を設定できます。「10」ずつ増減可能。
>RCF<	相対遠心力。200 rpm と最大ローター速度の間で速度となる数値を設定できます。「1」ずつ増減可能。 相対遠心力 (RCF) を入力できるのは、RCF 表示 (>RCF<) が有効である場合のみです。相対遠心力 (RCF) は遠心半径 (RAD) に依存します。RCF 表示にアクセスし、正しい遠心半径が設定されていることを確認してください。
RAD/mm	遠心半径。10 mm から 250 mm まで 1 mm ごとに調整可能。遠心半径を入力できるのは、RCF 表示 (RCF) が有効である場合のみです。
~_DEC	ブレーキ段階。[fast (高速)] = 短い時間で停止、[slow (低速)] = ゆっくり停止。

13.6 遠心分離パラメータの直接入力

速度 (RPM)、相対遠心力 (RCF)、遠心半径 (RAD) と実行時間は、事前に  キーを押さなくても   のキーで直接に入力できます。設定した遠心分離パラメータは、遠心操作を開始した後にのみ保存されます。

速度 (RPM):



必要に応じてキーを押して RPM 表示 (RPM) を有効にします。

RPM/RCF キーで希望する値を設定します。



例:

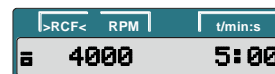

相対遠心力 (RCF) と遠心半径 (RAD):



必要に応じてキーを押して RCF 表示 (>RCF<) を有効にします。



RPM/R キーで希望する RCF 値を設定します。

CF



t

必要に応じてキーで希望の遠心半径を設定します。



例:



作動時間:

1 分以内の場合、作動時間は 1 秒ごとに設定でき、1 分を超える場合には 1 分ごとのみで設定できます。継続作動を設定するには、パラメータ [t/min (時間 / 分)] と [t/sec (時間 / 秒)] はゼロでなければなりません。時間表示 (t/min:s) 部位に「--:--」が表示されます。

例:

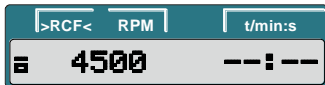

t

キーで希望する値を設定します。



例:

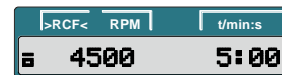

13.7 [SELECT (選択)] キーで遠心分離パラメータを入力する

作動時間には分と秒を設定できます (パラメータ t/min [時間/分] と t/sec [時間/秒])。継続作動を設定するには、パラメータ [t/min] と [t/sec] はゼロでなければなりません。時間表示 (t/min:s) 部位に「--:--」が表示されます。

例:

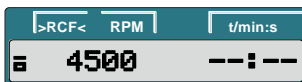

相対遠心加速度 (RCF) は遠心半径 (RAD) に依存します。RCF 入力中には設定された遠心半径が表示されます。選択後またはパラメータ入力中に 8 秒間キーを押さないと、ディスプレイには以前の値が表示されます。その場合にはパラメータを再度入力してください。**START PULSE** ボタンを押すと、設定が保存されます。複数のパラメータを入力した場合は、最後のパラメータを設定した後に **START PULSE** キーを押さなければなりません。パラメータの入力は、**STOP OPEN** キーを押すことでいつでもキャンセルできます。この場合、設定は保存されません。

例：表示 (RPM)

例：表示 (>RCF<)

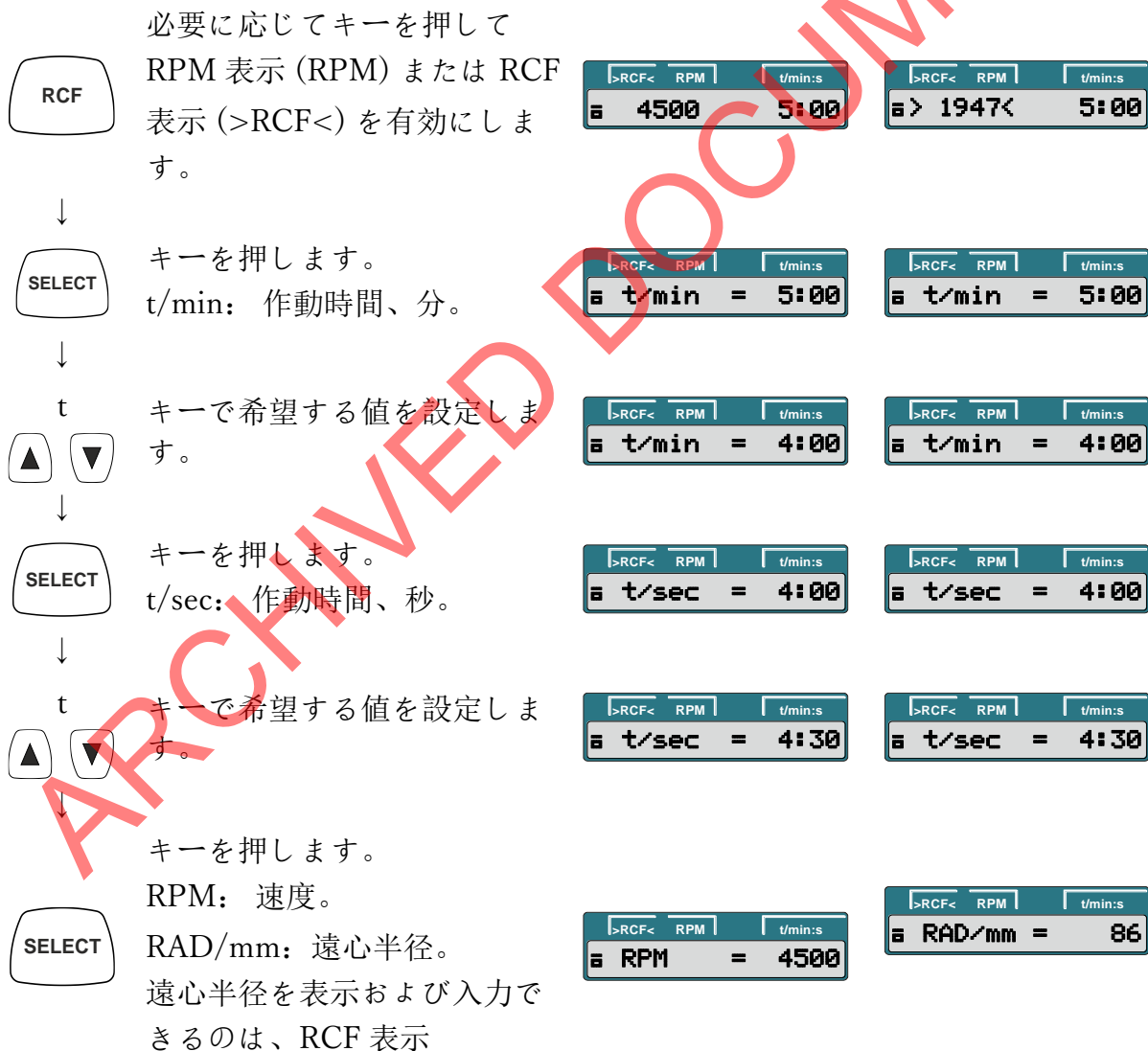

(>RCF<) が有効である場合のみです。

↓

t
▲ ▼

キーで希望する値を設定します。

4000 RPM t/min:s

>RCF< RPM t/min:s
RAD/mm = 67

↓

キーを押します。

SELECT

R: 遠心半径。
RCF: 相対遠心力。

67 RCF= 1947

↓

t
▲ ▼

キーで希望する値を設定します。

1198 RCF= 1198

↓

キーを押します。

SELECT

〜DEC: ブレーキ段階。

fast (高速): 短い時間で停止。
slow (低速): ゆっくり停止。

slow

slow

↓

t
▲ ▼

キーで希望する値を設定します。

fast

fast

↓

START PULSE

ボタンを押して設定を保存します。

4000 4:30

> 1198< 4:30



13.8 コントロールパネルディスプレイ

各回の遠心分離終了後、蓋がロック解除されている間に、残りの作動サイクル数（遠心分離回数）が短い間表示されます。

例:  The LCD display shows three indicators at the top: '>RCF<', 'RPM', and 't/min:s'. The main display area shows 'RemCycles= 16703'.

ローターの装填においてローター間の許容荷重差を超過した場合、遠心分離のサイクルは起動時に中止され、「IMBALANCE」が表示されます。

例:  The LCD display shows three indicators at the top: '>RCF<', 'RPM', and 't/min:s'. The main display area shows 'IMBALANCE'.

遠心分離は  キーを押すことでいつでも中止できます。遠心分離中に遠心分離パラメータを選択して変更することができます。ただし、変更した値は現在の遠心分離にのみ適用され、保存はされません。  キーでは RPM 表示 (RPM) と RCF 表示 (>RCF<) を随時切り替えられます。RCF 表示 (>RCF<) の場合には、遠心半径を入力しなければなりません。この場合、遠心分離機は蓋を開けなければ作動を再開しません。操作エラーおよび誤動作と表示されます。

例:  The LCD display shows three indicators at the top: '>RCF<', 'RPM', and 't/min:s'. The main display area shows 'Open the lid'.

13.9 事前設定した時間で遠心分離するには

必要に応じてキーを押して
RPM 表示 (RPM) または RCF
表示 (>RCF<) を有効にしま
す。

↓
希望する遠心分離パラメータを入力しま
す

↓
キーを押して遠心分離を開始し
ます。遠心分離中は、ローター
速度または結果的な RCF 値と
残り時間が表示されます。

↓
時間が経過した後、または **STOP
OPEN** キーを
押して遠心分離を中止した場合には、設
定したブレーキ段階で振れが生じます。
ブレーキ段階 \sim f が表示されます。

例：表示 (RPM)

>RCF<	RPM	t/min:s
■	4500	5:00

>RCF<	RPM	t/min:s
■	4000	4:30

>RCF<	RPM	t/min:s
□	4000	3:15

>RCF<	RPM	t/min:s
□	3980	\sim f

例：表示 (>RCF<)

>RCF<	RPM	t/min:s
■	> 1947<	5:00

>RCF<	RPM	t/min:s
■	> 1538<	4:30

>RCF<	RPM	t/min:s
□	> 1538<	3:15

>RCF<	RPM	t/min:s
□	> 1523<	\sim f

13.10 継続作動

必要に応じてキーを押して
RPM 表示 (RPM) または RCF
表示 (>RCF<) を有効にしま
す。

↓
希望する遠心分離パラメータを入力しま
す。パラメータ [t/min (時間 / 分)] と
[t/sec (時間 / 秒)] をゼロに設定しま
す

例：表示 (RPM)

>RCF<	RPM	t/min:s
■	4500	5:00

>RCF<	RPM	t/min:s
■	4000	--:--

例：表示 (>RCF<)

>RCF<	RPM	t/min:s
■	> 1947<	5:00

>RCF<	RPM	t/min:s
■	> 1538<	--:--

START PULSE

キーを押して遠心分離を開始します。遠心分離中は、ローター速度または結果的な RCF 値と残り時間が表示されます。

>RCF< RPM t/min:s
4000 2:45

>RCF< RPM t/min:s
> 1538< 2:45



STOP OPEN

キーを押して遠心分離を終了します。設定したブレーキ段階で振れが生じます。ブレーキ段階 ~ f が表示されます。

>RCF< RPM t/min:s
3980 ~ f

>RCF< RPM t/min:s
> 1523< ~ f

13.11 短期遠心分離

例：表示 (RPM)

例：表示 (>RCF<)

RCF

必要に応じてキーを押して RPM 表示 (RPM) または RCF 表示 (>RCF<) を有効にします。

>RCF< RPM t/min:s
4500 5:00

>RCF< RPM t/min:s
> 1947< 5:00



希望する遠心分離パラメータを入力します

>RCF< RPM t/min:s
4000 5:00

>RCF< RPM t/min:s
> 1538< 5:00



START PULSE

キーを長押しします。遠心分離中は、ローター速度または結果的な RCF 値と経過時間が表示されます。

>RCF< RPM t/min:s
4000 0:24

>RCF< RPM t/min:s
> 1538< 0:24



START PULSE

キーを再び放して遠心分離を終了します。設定したブレーキ段階で振れが生じます。ブレーキ段階 ~ f が表示されます。

>RCF< RPM t/min:s
3980 ~ f

>RCF< RPM t/min:s
> 1523< ~ f

13.12 緊急停止

キーを二度押します。
緊急停止の間、「fast（速
い）」ブレーキ段階で振れが生
じます（短い時間で停止しま
す）。ブレーキ段階 \sim f が表示
されます。



例：表示 (RPM)

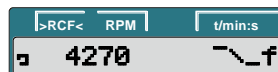

例：表示 (>RCF<)



13.13 サイクルカウンタ

遠心分離機には実行中のサイクル（遠心分離実行）をカウントするサイクルカウンタが
装備されています。各回の遠心分離終了後、蓋がロック解除されている間に、残りの作
動サイクル数（遠心分離回数）が短い間表示されます。

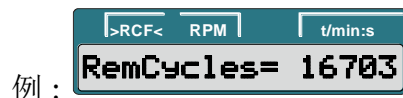

ローターの最大許可サイクル数を超えた場合、遠心分離を開始しようとするたびに以下
が表示され、遠心分離操作のやり直しが必要になります。安全上の理由から、ローター
を直ちに新品と交換しなければなりません。ローター交換後はサイクルカウンタを「0」
にリセットする必要があります。



13.14 サイクルカウンタをゼロにリセットする

ローター交換後、サイクルカウンタを再びゼロにリセットする必要があります。サイク
ルカウンタをゼロにリセットできるのは、ローターを新品に交換したときのみです。サ
イクルカウンタのリセットは、ローターが停止した状態で、次の手順で行います。この
手順は  キーを押すことでいつでも中止できます。この場合、設定は保存されませ
ん。



ボタンを 8 秒間長押しします。



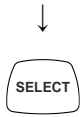

図のように表示されるまでキーを押します。



キーを押します。



例 :



次のメニューが表示されるまでキーを押します。
Cyc sum (サイクル合計) : 完了した作動サイクル数。

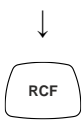

キーを押します。

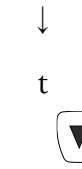

キーを押します。
完了した作動サイクル数がゼロにリセットされます。



ボタンを押して設定を保存します。

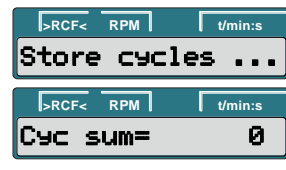

キーを2回押して [-> Time & Cycles (時間 & サイクル)] メニューを終了するか、3回押して [* MACHINE MENU * (マシンメニュー)] を終了します。



例 :



13.15 設定と照会

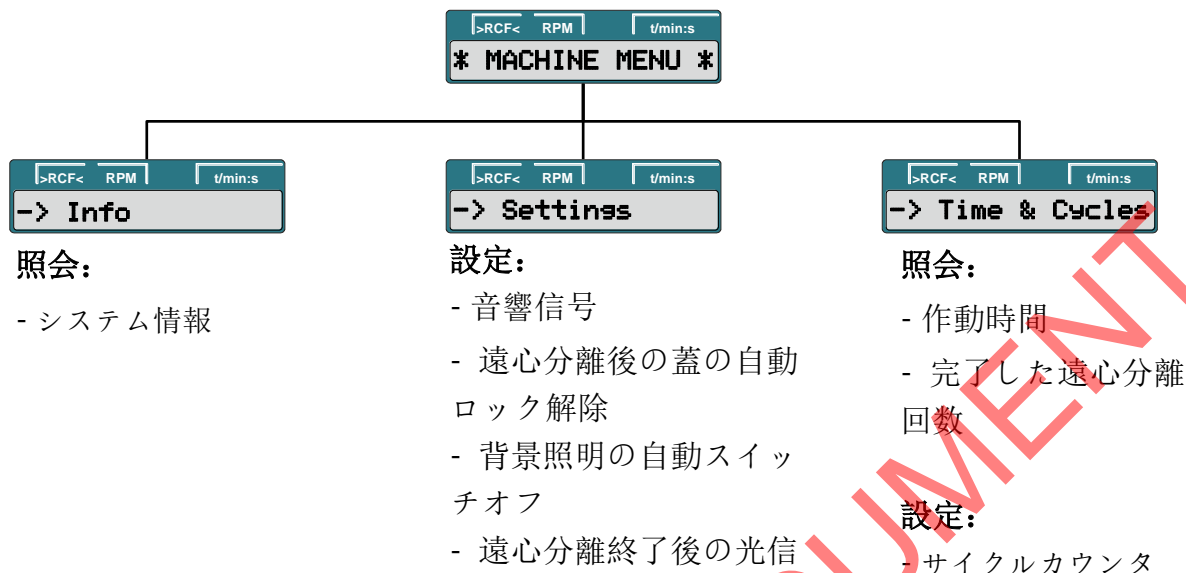

13.16 システム情報の照会

次のシステム情報を照会できます:

- 装置モデル
- 装置のプログラムバージョン
- 装置タイプ番号
- 装置製造年月日
- 装置シリアル番号
- 周波数変換器タイプ
- 周波数変換器プログラムバージョン

照会はローターが停止した状態で行います。システム情報は次の順序で表示されます。

この手順は  キーを押すことでいつでも中止できます。

 ボタンを 8 秒間長押しします。



 キーを押します。



>RCF< RPM t/min:s
* MACHINE MENU *



>RCF< RPM t/min:s
-> Info



キーを押します。
装置モデル。

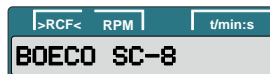

キーを押します。
装置のプログラムバージョン。

例：

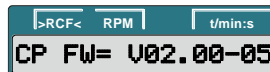

キーを押します。
Type#1 (タイプ No.1) : 装置タイプ
番号。

例：



キーを押します。
Type#2 (タイプ No.2) : [Type#1]
以外にもタイプがある場合の、タイプ
番号の続き。

例：



キーを押します。
装置製造年月日。

例：

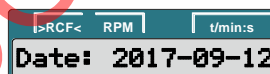

キーを押します。
装置シリアル番号。

例：



キーを押します。
周波数変換器タイプ。

例：



キーを押します。
周波数変換器プログラムバージョン。

例：





キーを2回押して [-> Info" (情報)]
メニューを終了するか、3回押して [*
MACHINE MENU *] (マシンメニュ
ー)] を終了します。

例:



13.17 お知らせ音

以下の場合にお知らせ音(電子音)が鳴ります: (1) 誤動作が生じた後に、2秒間隔で。
(2) 遠心分離が終了しローターが静止した後に、30秒間隔で。いずれかのキーを押すと、お知らせ音をストップできます。お知らせ音の設定は、ローターが停止した状態で、次の手順で行います。この手順は  キーを押すことでいつでも中止できます。この場合、設定は保存されません。



ボタンを8秒間長押しします。

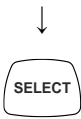

図のように表示されるまでキーを押
します。



キーを押します。

End beep (終了時の電子音): 遠



心分離終了時のお知らせ音。



off (オフ): 電子音は無効。

on (オン): 電子音は有効。

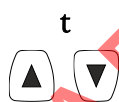

キーを使って、**off** または **on** に設定
します。



キーを押します。

Error beep (エラー時の電子音):

誤作動発生時の音響信号。



off: 電子音は無効。

on: 電子音は有効。

↓

t

▲ ▼

キーを使って、**off** または **on** に設定します。

>RCF<	RPM	t/min:s
Error beep =off		

>RCF<	RPM	t/min:s
Error beep =on		

↓

キーを押します。

Beep volume (電子音ボリューム) : お知らせ音のボリューム。

SELECT

min (最小) : ソフト

mid (中程度) : ミディアム

max (最大) : ラウド

>RCF<	RPM	t/min:s
Beep volume =min		

>RCF<	RPM	t/min:s
Beep volume =mid		

>RCF<	RPM	t/min:s
Beep volume =max		

↓

t

▲ ▼

キーを使って、**min**、**mid**、または **max** に設定します。

>RCF<	RPM	t/min:s
Beep volume =min		

>RCF<	RPM	t/min:s
Beep volume =mid		

>RCF<	RPM	t/min:s
Beep volume =max		

↓

START PULSE

ボタンを押して設定を保存します。

>RCF<	RPM	t/min:s
Store settings...		

>RCF<	RPM	t/min:s
-> Settings		

↓

STOP OPEN

キーを 1 回押して [->Settings (設定)] メニューを終了するか、2 回押して [* MACHINE MENU * (マ

>RCF<	RPM	t/min:s
* MACHINE MENU *		

Example:

>RCF<	RPM	t/min:s
←	4500	5:00

13.18 遠心分離終了後の点灯サイン

遠心分離終了後にディスプレイのバックライトが点滅し、プロセスが終了したことを視覚的に知らせます。

点灯サインのオン/オフは、ローターが静止状態の場合に次のように切り替えられます。

この手順は  キーを押すことでいつでも中止できます。

SELECT

ボタンを 8 秒間長押しします。

>RCF<	RPM	t/min:s
* MACHINE MENU *		

↓

SELECT

図のように表示されるまでキーを押します。

>RCF<	RPM	t/min:s
-> Settings		

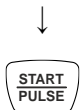

キーを押します。



図のいずれかが表示されるまでキーを押します。

End blinking (終了時のバックライト点滅) : ディスプレイバックライトの点滅による、プロセス終了通知。



off (オフ) : バックライトが点滅しない。

on (オン) : バックライトが点滅する。

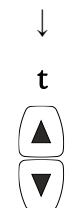

キーを使って、**off** または **on** に設定します。



ボタンを押して設定を保存します。



キーを1回押して [->Settings (設定)]メニューを終了するか、2回押して[* MACHINE MENU * (マシンメニュー)]を終了します。



例 :



13.19 遠心分離後の蓋のロック自動解除

遠心分離プロセス後に蓋を自動的にロック解除するかどうかを設定できます。この設定は、ローターが停止した状態で、次の手順で行います。この手順は  キーを押すことでいつでも中止できます。この場合、設定は保存されません。

SELECT

ボタンを8秒間長押しします。

```
>RCF< RPM t/min:s
* MACHINE MENU *
```

SELECT

図のように表示されるまでキーを押します。

```
>RCF< RPM t/min:s
-> Settings
```

START PULSE

キーを押します。

```
>RCF< RPM t/min:s
End beep =off
```

```
>RCF< RPM t/min:s
End beep =on
```

図のいずれかが表示されるまでキーを押します。

SELECT

Lid AutoOpen (蓋ロック自動解除)：遠心分離後の蓋のロック自動解除。

```
>RCF< RPM t/min:s
Lid AutoOpen=off
```

```
>RCF< RPM t/min:s
Lid AutoOpen=on
```

off (オフ)：蓋は自動的にロック解除されません。

on (オン)：蓋は自動的にロック解除されます。

↓

t
▲ ▼

キーを使って、**off** または **on** に設定します。

```
>RCF< RPM t/min:s
Lid AutoOpen=off
```

```
>RCF< RPM t/min:s
Lid AutoOpen=on
```

START PULSE

ボタンを押して設定を保存します。

```
>RCF< RPM t/min:s
Store settings...
```

```
>RCF< RPM t/min:s
-> Settings
```

↓

STOP OPEN

キーを1回押して [-> Settings (設定)] メニューを終了するか、2回押して [*MACHINE MENU* (マシンメニュー)] を終了します。

```
>RCF< RPM t/min:s
* MACHINE MENU *
```

例：

```
>RCF< RPM t/min:s
6 4500 5:00
```

13.20 ディスプレイのバックライト

省エネのために、遠心分離後、ディスプレイのバックライトが2分後に消えるように設定することができます。この設定は、ローターが停止した状態で、次の手順で行います。この手順は  キーを押すことでいつでも中止できます。この場合、設定は保存されません。





キーを 1 回押して [-> Settings (設定)] メニューを終了するか、2 回押して[* MACHINE MENU * (マシンメニュー)] を終了します。



例:



13.21 作動時間と遠心分離回数の照会

作動時間には、内部作動時間と外部作動時間とがあります。内部作動時間：装置がオンであった合計時間。外部作動時間：以前の遠心分離実行全体の合計時間。照会はローターが停止した状態で行います。システム情報は次の順序で表示されます。この手順は

キーを押すことでいつでも中止できます。



ボタンを 8 秒間長押しします。



図のように表示されるまでキーを押します。

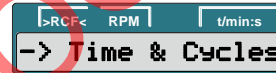

キーを押します。

例:



TimeExt (外部時間) : 外部作動時間。



キーを押します。

例:



TimeInt (内部時間) : 内部作動時間。



キーを押します。

例:



Starts (開始数) : 遠心分離機の全実行回数。



キーを2回押して [-> Time & Cycles (時間 & サイクル)] メニューを終了するか、3回押して [* MACHINE MENU * (マシンメニュー)] を終了します。



例:





14 エラー

以下の故障表を使用しても故障を解消できない場合は、カスタマーサービスに連絡し、遠心分離機の種類とシリアル番号をお伝えください。どちらの番号も装置の銘板に記載されています。

次の手順で MAINS RESET (メインリセット) を行います: 電源スイッチをオフにします (スイッチ位置「0」)。少なくとも 10 秒待ってから再び電源スイッチを入れます (スイッチ位置「I」)。

メッセージ / エラー	原因	解決方法
表示なし	電圧なし 電源入力ヒューズ不良。	<ul style="list-style-type: none"> - 配電電圧を確認します。 - 主電源入力ヒューズを確認し、主電源ヒューズの交換手順を参照してください。 - 電源スイッチをオンにします。
IMBALANCE (不均衡)	ローターが不均衡に装填されている。	<ul style="list-style-type: none"> - ローターが静止した後に蓋を開けます。 - ローターの装填をチェックします。 - 遠心分離を繰り返します。
MAINS INTER (電源中断)	遠心分離中の電源障害。 (遠心分離プロセスが未完了。)	<ul style="list-style-type: none"> - ローターが静止した後に蓋を開けます。
MAINS INTERRUPT (電源中断)		<ul style="list-style-type: none"> - Start/pause ボタンを押します。 - 必要があれば遠心分離を繰り返します。
TACHO ERROR (タコメーターエラー)	1, 2	<ul style="list-style-type: none"> - ローター静止時に MAINS RESET を実行します。

LID ERROR (蓋エラー)	4.1 - 4.127	蓋のロックまたは蓋を閉じる際のエラー。	
OVER SPEED (速度過剰)	5	回転が速すぎる	
VERSION ERROR (バージョンエラー)	12	間違った遠心分離機モデルが検出された。 エラー/不良状態のエレクトロニクス	
UNDER SPEED (速度不足)	13	回転が遅すぎる	
CTRL ERROR (制御エラー)	22.1, 25.2		
CRC ERROR (CRC エラー)	27.1	エラー/不良状態のエレクトロニクス	<ul style="list-style-type: none"> - ローター静止時に MAINS RESET を実行します。
COM ERROR (通信エラー)	31 - 36		
FC ERROR (FC エラー)	60, 61.1 - 61.21, 61.64 - 61.142		
FC ERROR (FC エラー)	61.23		<ul style="list-style-type: none"> - 回転表示  が点灯し回転している限り、装置のスイッチをオフにすることはできません。記号  (蓋ロックオン) が表示されるまで待ちます (約 120 秒後)。その後、MAINS RESET を実行します。
TACHO ERROR (タコメーターエラー)	61.22	速度測定エラー	
FC ERROR (FC エラー)	61.153	エラー/不良状態のエレクトロニクス	<ul style="list-style-type: none"> - MAINS RESET を行います。 - 提供される指示に従ってローターの負荷を確認してください。 - 遠心分離を繰り返します。

15 相対遠心力 (RCF)

相対遠心力 (RCF) は重力加速度 (g) の倍数で表されます。これは相対的な値であり、分離性能と沈降性能を比較する役目を果たします。相対遠心力 (RCF) は、毎分回転数および遠心半径に比例します。以下の式を使用して計算できます：

$$\text{RCF} = \left(\frac{\text{RPM}}{1000} \right)^2 \times r \times 1,118 \quad \Rightarrow \quad \text{RPM} = \sqrt{\frac{\text{RCF}}{r \times 1,118}} \times 1000$$

RCF = 相対遠心力

RPM = 回転速度 (毎分回転数)

r = mm 単位での遠心分離半径 = 回転軸の中心から遠心分離機容器の底部までの距離。

16 移動と保管

装置を移動する前に移動用固定具を取り付けなければなりません。装置や付属品は密閉されている乾燥した部屋でのみ保管できます。デバイスとアクセサリを輸送または保管する場合は、次の条件を満たしている必要があります。

周囲温度：-20° C ~ +60° C

相対湿度：10% ~ 80%、結露しないようにすること

17 電源入力ヒューズを交換する

まず、主電源スイッチをオフにし、デバイスを主電源から切り離します。電源入力ヒューズが入っているヒューズホルダー (A) は電源スイッチの隣にあります。装置のプラグソケットから接続ケーブルを外します。スナップフィット (B) をヒューズホルダー (A) に押し付け、取り外します。故障した主電源入力ヒューズを交換します。メーカーが提供する遠心機のタイプに対して定義された定格のヒューズのみを使用してください。ヒューズホルダーを再び挿入し、カチッと音がして固定されるまではめ込みます。装置を電源に再接続します。

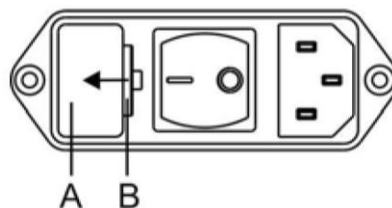

18 装置の返送

返送にあたっては、装置に移動用固定具を取り付ける必要があります。デバイスまたはその付属品を正規の製造元に返却する場合、人、環境、および材料を保護の観点から、出荷前に汚染物質を除去して洗浄する必要があります。正規の製造業者は汚染されたデバイスまたは付属品の受領を拒否することができます。またクリーニングと消毒にかかる費用はお客様の負担となります。

19 廃棄

廃棄する前に、人、環境、および資産を保護するために、装置の除染およびクリーニングを行う必要があります。装置の廃棄に際しては該当する法定規則に必ず従わなければなりません。2002/96/EC (WEEE) 指針に準じて、2005年8月13日以降に供給された装置はすべて、家庭ごみの一部として処分することはできません。この機器はグループ 8 (医療機器) に属し、企業間 (B2B) の分野に分類されます。X印のついたゴミ箱のアイコンは、機器が家庭ごみの一部として処分できないことを示すものです。諸国の個々の廃棄物処理指針は国により異なる場合があります。必要であれば供給元にお問い合わせください。



아래 기호 표는 참고 용입니다. 해당 기호는 제품 포장 레이블을 참조하십시오.

상징	기호 설명
	주의!
	전자 장치 사용 지침
	제조업체
	BioHorizons products는 CE 마크를 획득했으며 의료 제품 지침 93/42/EEC 요건을 이행합니다93/42/EEC
	참조/ 문서 번호
	로트/ 배치 번호
	재사용하지 마십시오
	다시 멸균하지 마십시오
	유효기간
	감마선 조사 멸균
	장치 제조일
	주의: 미국 연방법은 본 장치의 판매, 유통 및 사용, 주문을 치과 의사 및 외과 의사로 제한합니다

상징	기호 설명
	홈 포지션
	포장이 손상되면 사용하지 마십시오
	의료 장치
	비 멸균
	건조하게
	깨지기 쉬운; 조심히 다루세요
	온도 한계
	이쪽으로
	습도 한계
	경고; 생물학적 위험
	중요 사항
	전기 및 전자 장치의 개별 수집.
	유럽 연합 공인 대표

1 사용 표시

IntraSpin 시스템은 환자가 있는 현장에서 적은 양의 혈액 샘플로부터 안전하고 신속하게 자가 혈청(L-PRF)을 준비하기 위한 용도입니다. L-PRF 는 골 결손에 적용하기에 앞서 취급 특성을 개선하기 위해 자가이식편 및/또는 동종이식편 뼈와 혼합됩니다. 사용 설명서의 모든 정보를 준수하는 것도 의도 된 사용의 일부입니다.

2 금기

IntraSpin 원심 분리기는 장치의 사용 목적에 명시된 목적으로 만 사용됩니다. 장치의 다른 용도는 의도하지 않은 것으로 간주됩니다. 알코올 중독 또는 정신과 적 장애, 혈액 육증, 통제되지 않은 당뇨병, 갑상선 기능 항진증, 구강 감염, 악성 종양 또는 마지막에 심근 경색이있는 환자의 임상 상황 중 하나 이상에서는 IntraSpin 원심 분리기 사용이 금기입니다. 12 개월. AIDS와 같은 면역계를 손상시키는 전신 질환이있는 환자, 임플란트 부위의 치유를 손상시키는 약물 환자, 구강 위생 절차에 대한 불충분 한 병력이있는 환자.

항 응고 요법에 참여하는 환자. 이들 환자는 PRF 의 이점에서 배제되지 않고, 분리 시점이 효과적이기 위해서는 치료 시점이 원심 분리기에 추가 시간을 추가해야한다.

3 안전 주의사항

- 본 설명서의 모든 지침을 따르지 않은 경우 제조업체의 보증 클레임은 고려되지 않을 것입니다.
- 작동 지침은 장치의 일부입니다. 항상 쉽게 사용할 수 있어야합니다. 장치가 다른 위치에 설치된 경우 작동 지침이 제공되어야합니다.
- 원심분리기는 양호하고 안정적인 기반에 설치해야 합니다.
- 원심분리기를 사용하기 전에 로터가 견고하게 배치되었는지 확인하십시오.
- EN / IEC 61010-2-020에 따라, 원심분리기가 작동 중일 때 원심분리기 주위 300 mm의 안전 범위 내에 사람, 위험 물질 또는 물체가 있어서는 안 됩니다.
- 로터, 서스펜션 및 부속품은 미량의 부식이나 기계 손상이 있거나, 이러한 부품들의 약관이 만료된 경우 더 이상 사용할 수 없습니다.
- 원심분리 챔버에 안전 관련 손상이 있는 경우 원심분리기를 더 이상 작동할 수 없습니다.

- 온도 제어 기능이 없는 원심분리기의 경우, 실온이 증가하거나 장치를 자주 사용할 경우 원심분리 챔버 온도가 올라갈 수 있습니다. 그러므로 온도로 인해 샘플 물질이 변경될 수 있다는 것을 배제해서는 안 됩니다.
- 원심분리기를 처음 작동하기 전에 작동 지침을 읽고 주의를 기울여야 합니다. 작동 지침을 읽고 이해한 직원만 장치를 작동할 수 있습니다.
- 사고 예방 관련 법적 규정 및 작동 지침에 따라 안전하고 전문적인 형태로 작업 시 인정된 전문 규정을 따라야 합니다. 장치가 사용되는 국가의 국내 규정을 토대로 사고 방지 및 환경 보호와 관련한 다른 지침과 함께 이러한 작동 지침을 읽어야 합니다.
- 이런 목적으로 제공되는 작업장에서 원심분리기를 사용하는 것과 관련해 산업 안전에 대한 국가별 요건을 충족하는 것은 사용자의 책임입니다.
- 이 원심분리기는 작동에 매우 안전한 첨단 장비입니다. 하지만 교육을 받지 않은 직원이 사용하거나 부적절한 방법 또는 설계된 목적에 따라 사용하지 않을 경우 사용자 또는 타인이 위험할 수 있습니다.
- 작동 중에 원심분리기를 이동하거나 부딪히는 일이 있어서는 안 됩니다.
- 장애 또는 비상 해제의 경우 회전을 멈추기 전에 로터에 손을 대지 마십시오.
- 응결로 인한 손상 방지를 위해, 냉장실에서 고온실로 변경할 때 원심분리기는 주전원에 연결하기 전에 고온실에서 최소 3시간 동안 예열하거나 냉장실에서 30분 동안 열을 생성하며 가동해야 합니다.
- 분당 최대 회전으로 원심 분리기를 이용할 때 물질 혼합물 또는 물질의 밀도가 1.2 kg/dm³을 초과하지 않을 수 있습니다.
- 저울이 허용 가능 한도 내에 있을 경우에만 원심분리기를 작동할 수 있습니다.
- 원심분리기는 폭발 위험 지역에서 작동할 수 없습니다.
- 원심분리기는 다음과 사용해서는 안 됩니다: 인화성 또는 폭발성 물질 많은 에너지를 생성하며 서로 반응하는 물질.
- 이 원심분리기에 사용할 수 있는 생물 안전 시스템은 없습니다.
- 원심분리기는 로터, 행어 및 부속품의 기계적 무결성을 손상시킬 수 있는 부식성이 강한 물질을 이용해 작동해서는 안 됩니다.
- 제조업체가 인가한 직원에 의해서만 수리를 수행해야 합니다.

- 환자에게 가장 높은 수준의 임상 안전성을 제공하기 위해 Intra-Lock 제품은 사람의 혈장에 거부 반응을 일으키지 않는 재료로 만들어졌습니다.
- 이 제품은 모든 시장에서 판매인가가 난 것이 아니기 때문에 귀하의 시장에서 이용하지 못할 수 있습니다. 자세한 내용은 현지 Intra-Lock 담당자에 문의하십시오.

4 인트라 스피ن 시스템 구성 요소

구성 요소	시스템 당 수량
다음에 포함한 IntraSpin 원심 분리기 :	1
전원 케이블	1
퓨즈	2
육각 핸드 렌치	1
Greiner 채혈 튜브 및 밸런싱 튜브(일회용).	150
그리 너 안전 혈액 수집 세트 + 홀더, 21G (단일 사용)	24
라텍스 프리 지혈대	1
테스트 튜브랙	1
외과 용 가위	1
외과 조직 겸자	1
등근 스테인리스 사발	1
직사각형 스테인리스 스틸 보울	1
듀얼 바이오 소재 캐리어 주걱	1
이중 생체 물질 포장기	1
Xpression® 박스	1

IntraSpin 원심 분리기와 직접 사용하기 위해 검증 된 호환 구성 요소 만 권장하고 보증합니다:

호환 부품	기술
455092	튜브 9ml CAT 혈청 응고 활성화 제, 빨간 캡
455001	화이트 캡 9ml Z 무첨가 튜브

BHEXZ (E613)	IntraSpin 16 진수 키, 110V 및 220V
BROTORZ (E3694)	인트라 스피ن 로터, 100V 및 220V
BPOWER110Z (E1673)	인트라 스피ن 전원 코드, 110V
BPOWER220Z (E1669)	인트라 스피ن 전원 코드, 220V
BTUBEHOLDZ (E872 x 1)	IntraSpin 튜브 홀더 교체
BFUSE110Z (E997)	인트라 스피ن 퓨즈 110v
BFUSE220Z (E891)	인트라 스피ن 퓨즈 220v

5 간단한 중앙 설정

원심 분리기 바닥에서 운송용 볼트를 제거하고 보관하십시오.

AC 케이블을 연결하고 전기 콘센트에 꽂습니다.

장치 뒷면의 로커 스위치를 사용하여 전원 원심 분리기를 켭니다.

속도와 시간을 선택하십시오: 속도= 2700 & 시각= 12:00 분
시작(START)을 누릅니다.

원심분리기 커버는 각 사이클이 끝날 때 자동으로 열립니다.

첫 번째 절차 후 설정이 변경되지 않는 한 시간과 속도가 원심분리기 메모리에 기록됩니다.

6 채혈 튜브 및 채혈 세트 주의사항 및 지침

- 이물질이 있는 경우 튜브를 사용하지 마십시오.
- 채혈 튜브가 완전히 채워지도록 해야 합니다.
- 모든 생물학적 샘플 및 채혈을 위한 "날카로운 물건"(바늘 및 채혈 세트 등)은 귀 시설의 정책과 절차에 따라 취급하십시오.
- 바늘을 구부리지 마십시오.
- 바늘 보호 장치가 활성화된 이후에 강제로 노출시키거나 재활성화하지 마십시오.
- 생물학적 시료에 노출 될 경우 (예 : 주사침 자상 등), HIV (AIDS), 간염 바이러스 또는 기타 감염 질환에 전염될 수 있으므로 적절한 의학적 조치를 취하십시오.
- 채혈 시 사용한 모든 "날카로운 기구"는 승인 된 의료폐기물 용기에 폐기하십시오.
- 시료를 주사기에서 튜브로 옮기는 것은 권장하지 않습니다.

- 정맥 (IV) 라인을 통해 채혈 할 경우, 해당 기관의 정책 및 절차에 따라 라인에 IV 용액이 제거되었는지 확인 후 혈액 수집 튜브에 혈액을 수집하십시오.
- 혈액 응고 촉진제는 튜브 표면에 흰색으로 나타날 수 있으며 튜브 성능에 영향을 미치지 않습니다. 튜브에 다른 변색이나 침전물이 있으면 사용하지 마십시오.
- 유통기한이 지난 튜브는 사용하지 마십시오.
- 채혈 튜브는 4~25°C(40~77°F)에서 보관하십시오.
- 채혈 세트(바늘 및 홀더)는 4~36°C(40~97°F)에서 보관하십시오.
- 직사광선에 노출하지 마십시오. 권장하는 최대 보관 온도를 초과할 경우 튜브 품질에 손상을 일으킬 수 있습니다 (예 : 진공 손실, 착색 등).
- 역류를 방지하기 위해 환자의 팔을 아래로 향하게 하고, 캡을 위쪽으로 향하게 하여 튜브를 잡고, 혈액이 튜브로 유입됨과 동시에 지혈대를 풀어주십시오. 정맥 천자 시 튜브 내용물이 바늘 끝 또는 캡에 닿지 않도록 하십시오.
- 정맥 천자를 수행하기 전에 다음 물품을 준비하고, 사용하기 편리한 곳에 두십시오: 필요한 모든 채혈 튜브, 양성 환자의 샘플 식별을 위한 식별 라벨, 채혈 바늘 및 홀더, 천자 부위를 닦기 위한 알코올 스왑, 거즈, 지혈대, 반창고 또는 상처밴드, 승인 된 의료폐기물 용기. 혈행성 병원균에 노출되지 않도록 적절한 PPE (개인보호장비)를 권장합니다 (예 : 장갑, 실험실 코트, 고글 등).

정맥 천자 기술 및 혈액 샘플 수집:

채혈관에는 항응고제가 없기 때문에 가능한 한 빨리 채혈해야 합니다. 혈액 샘플이 즉시 응고되기 시작합니다. 정맥 천자 및 혈액 채취 튜브 취급시 노출 위험을 최소화하기 위해 장갑을 착용하십시오. 혈액을 채취하기 전에 선택한 소독제 물티슈로 혈액 튜브 캡의 상단을 닦으십시오. 니들 밸브 부분의 덮개를 제거하십시오. 적절한 방부제로 정맥 천자 부위를 준비하십시오. 클렌징 후 정맥 천자 부위를 두드리지 마십시오. 환자의 팔을 아래로 향하게 놓습니다. 바늘 실드를 제거하십시오. 팔을 아래로 향한 상태에서 정맥 천자를 수행하고 튜브 캡을 맨 위쪽으로 수행하십시오. 필요한 경우 테이프로 바늘을 고정하십시오. 혈액 수집 튜브를 혈액 수집 튜브의 고무 다이어프램을 뚫고 홀더와 니들 밸브에 밀어 넣습니다. 뚜껑을 관통 할 때 혈액 수집 튜브를 홀더의 중앙에 배치하여 측면 침투 및 후속적인 진공 손실을 방지하십시오. 혈액이 혈액 수집 튜브에 나타나면 즉시

지혈대를 제거하십시오. 절차 중에는 항상 엄지 손가락으로 수집 튜브를 눌러 제자리에 고정하십시오. 이것은 완전한 진공 흡입을 보장합니다. 혈액 수집 튜브가 자동으로 채워집니다. 채혈관에 혈액이 유입되지 않거나 적절한 검체를 채취하기 전에 혈류가 중단되면 다음 단계를 수행하여 만족스러운 채혈을 완료하십시오:

- 혈액 수집 튜브를 앞으로 밀어 캡이 관통 되도록 합니다.
- 바늘이 정맥에 올바르게 위치해 있는지 확인하십시오.
- 혈액이 유입되지 않을 경우 채혈 튜브를 제거한 후 적절하게 폐기하고 새 채혈 튜브를 홀더에 밀어 넣습니다.
- 두 번째 채혈 튜브에도 혈액이 유입되지 않으면 바늘과 채혈 튜브를 모두 제거하고 적절하게 폐기하십시오. 위 절차를 반복하십시오.
- 혈액이 채혈 튜브의 최대 용량 주입 라인에 도달하면 튜브를 홀더에서 부드럽게 빼냅니다. 두 번째 튜브로 반복하십시오.

홀더에서 분리한 튜브는 조심스럽게 뒤집어놓습니다. 혈액 샘플로 채워진 튜브를 흔들지 마십시오. 격렬한 혼합은 거품 또는 용혈을 일으킬 수 있습니다. 혈청 튜브에서 혼합이 불충분하거나 혼합이 지연되면 응고가 지연 될 수 있습니다.

혈액 샘플 채취가 완료되면 정맥에서 바늘을 제거하십시오. 허브의 양쪽을 눌러 잠겨지게 하여 바늘의 보호 장치(보호 실드)를 활성화하십시오. 딸깍하는 소리가 들릴 때까지 보호 장치를 뒤로 미십시오. 바늘 찔림 및 혈액 노출의 위험이 있으므로 바늘을 다시 씌우지 마십시오. 사용한 바늘은 홀더와 함께 적절한 생물학 위험물 폐기 용기에 담아 폐기하십시오. 출혈이 멈출 때까지 마른 멸균 면봉으로 천자 부위에 압력을 가하십시오. 원하는 경우 응고가 발생하면 붕대를 바르십시오. 채워진 채취 튜브는 똑바로 세워 두는 것이 좋습니다. 두 번째 혈액 수집 튜브가 가득 차면이를 제거하고 회전자와 균형을 맞추기 위해 반대 위치의 원심 분리기에 첫 번째 및 두 번째 튜브를 놓습니다. IntraSpin 원심 분리기의 덮개를 닫고 START 버튼을 눌러 12 분 동안 회전시킵니다.

두 개 이상의 혈액 튜브가 필요할 경우 다음 절차를 따르십시오. 처음 두 혈액 튜브를 채취하여 부드럽게 뒤집은 후 즉시 IntraSpin 원심분리기 안에 서로 마주 보는 위치에 배치하여, 원심분리기의 수평이 잘 맞도록 하십시오. 덮개를 닫고 START 버튼을 누르고

남아있는 혈액 튜브를 수집하는 동안 원심 분리기가 작동되도록합니다. STOP 버튼을 누르고 원심 분리기가 완전히 멈출 수 있도록합니다. 덮개가 열릴 것입니다. 나머지 튜브를 즉시 서로 반대편의 원심 분리기에 놓고 적절한 균형을 유지하고 START 버튼을 눌러 권장 프로토콜을 재설정하고 완료하십시오.

튜브는 늘 쌍으로 두고 원심분리기 로터의 수평을 맞추기 위해 마주 보는 위치에 두십시오. 시작(START) 버튼을 누르기 전에 튜브는 로터 안에서 항상 균형을 이뤄야 합니다. 그렇지 않으면 원심분리기에 심각한 손상, 부적절한 응고 및/또는 분리의 원인이 될 수 있습니다. 튜브의 균형이 맞지 않으면 원심 분리 중에 진동이 너무 많아 L-PRF 피브린 응고가 나빠질 수 있습니다.

원심분리할 혈액 샘플 개수가 홀수인 경우 흰색 뚜껑 밸런싱 튜브(예: 455001)에 표시된 선까지 물을 채운 후 짝이 맞지 않는 곳에 배치하십시오. 이렇게 하면 원심분리기가 적절한 균형을 이룰 것입니다.

혈액 샘플을 채취한 뒤 바로 원심 분리를 시작하십시오. 지연은 혈액 분리 절차에 영향을 미치고 L-PRF 피브린 응고를 불량하게 만듭니다.

7 L-PRF 준비

원심 분리 후 세 층을 관찰할 수 있습니다.

1. 상층부 = 혈소판이 거의 없는 혈청(PPP).
2. 중층부 = 피브린 응고: L-PRF.
3. 하층부 = 적혈구 응고.

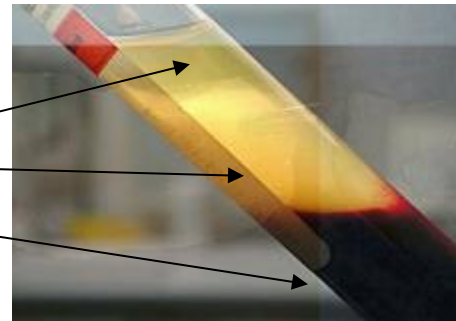

L-PRF 섬유소 막 또는 플러그는 비교적 빠르게 준비해야 합니다. 원심 분리 후 0-15 분 이내에 하지 않으면 혈청이 방출되어 응고가 줄어들 것입니다. 원심 분리 후 각 튜브에서 고무 마개를 제거하십시오. 수술 조직 검자를 사용하여 튜브에서 L-PRF 응고를 제거합니다. 이중 생체 물질 운반체 주걱을 사용하여 L-PRF® 피브린 응고에서 연합 바로 아래에있는 적혈구 응고를 부드럽게 긁어내어 최소한의 잔류량의 적혈구 만 L-PRF 응고에 부착되도록합니다. 피브린 응고를 Xpression 천공 트레이에 놓습니다.

8 섬유 매트릭스 준비

프로토콜#1 L-PRF 막

각 피브린 응고를 Xpression 천공 트레이에 놓습니다. 피브린 응고가 모두 배치되면 응고에 압력을 가하지 않고 Xpression 압축 플레이트와 Xpression Weighted 커버를 피브린 응고 위에 놓습니다.

삼출물이 트레이 바닥으로 여과되는 동안 덮개의 무게가 천천히 피브린 응고를 아래로 누르도록 합니다. 가중 덮개에 압력을 가하지 마십시오. 가중 덮개에 중력이 가해지면 응고가 부드럽게 압축되고 섬유소 네트워크를 손상시키지 않으면서 L-PRF 응고에서 혈청이 발현됩니다.

섬유소 막을 제거하고 사용하기 전에 5 분 이상 기다리십시오. 실제 사용 시간이 될 때까지 피브린 막을 제거하지 마십시오. 피브린 막은 최대 3 시간 동안 Xpression 상자에 남아있을 수 있습니다.

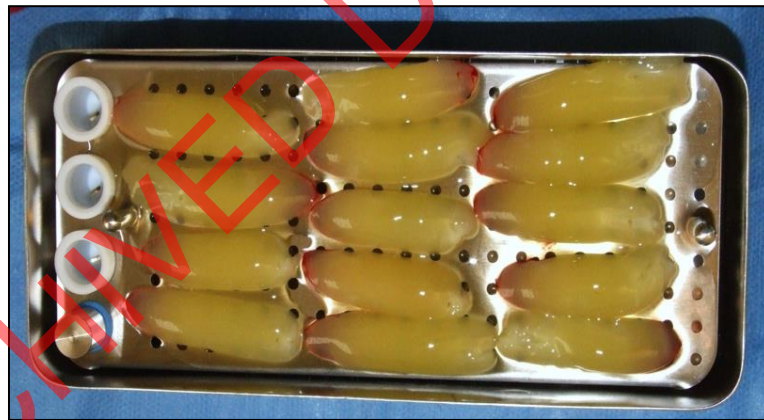

프로토콜#2 L-PRF 플러그

흰색 플러그 제작 실린더 안에 피브린 응고를 놓습니다. 피스톤을 사용하여 흰색 L-PRF 플러그 제작 실린더 내부의 응고를 천천히 누릅니다. 피스톤의 상단 가장자리가 흰색 L-PRF 플러그 제작 실린더의 상단 가장자리와 같은 높이가 될 때까지 계속 누릅니다. 이 기술을 사용하면 추출 소켓을 위한 두껍고 둥근 피브린 플러그를 형성할 수 있습니다. 단일 치아의 경우 하나의 L-PRF 플러그로 충분할 수 있습니다. 사전

어금니에는 2 개의 L-PRF 플러그가 필요할 수 있으며 추출 소켓의 크기와 생성 된 피브린 응고의 크기에 따라 어금니에는 3 개의 L-PRF 플러그가 필요할 수 있습니다.

L-PRF®는 작업 특성상 선호하는 생체재료와 함께 사용하기에 우수한 매개체가 됩니다. 다음의 혼합 프로토콜 중 하나를 사용하면 생체재료가 피브린 매트릭스에 갇혀 처리량 및 생물학적 용량이 증가합니다.

프로토콜#3 - 생체 적합 물질/L-PRF 혼합물

생체재료로 원하는 모양과 두께로 부드럽게 형성할 수 있는 '퍼티 유사' 혼합물을 만들기 위해서 다음 방법을 따르십시오. 수술 곡선 가위로 멸균 접시에 L-PRF 피브린 막을 작은 조각으로 부드럽게 자릅니다. 원하는 만큼의 골이식재를 추가하십시오. L-PRF®와 이식재를 완전히 섞어주십시오. 이 혼합물은 이중 생체 물질 운반체 주격을 사용하여 결함에 배치 될 수 있습니다.



프로토콜#4 - 생체재료 /L-PRF 혼합물

미리 정한 양만큼의 골이식재를 살균 볼이나 트레이에 넣으십시오. 발현 된 L-PRF 막 (들) 또는 L-PRF 막 조각을 그래프 트 물질로 L-PRF 막의 전체 표면적을 덮는 그래프 트 물질에 담근다. 대안 적으로, 그래프 트 재료는 그래프 트 재료로 전체 표면적을 덮는 L-PRF 막 상에 뿌려 질 수있다. 참고 : 습한 L-PRF 멤브레인은 건조기 L-PRF 멤브레인보다 약간 더 많은 이식 재료를 보유 할 수 있습니다. 그래프 트 재료는 L-PRF 의 표면에 달라 붙어야하지만, 원한다면 그래프 트 재료를 L-PRF 막에 부드럽게 누르십시오. 수술 조직 검자를 사용하여이 혼합물을 결함에 넣을 수 있습니다.

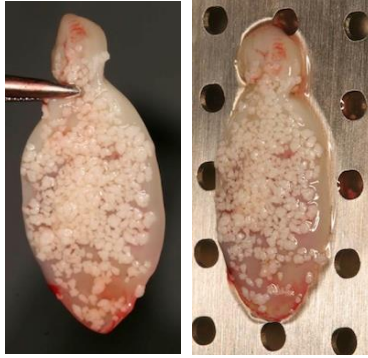

프로토콜#5 - 생체 물질 수화

멸균 보울 또는 트레이에 원하는 양의 골 이식재를 첨가하십시오. Xpression 수집 트레이 바닥에서 삼출물을 이용하여 이식편을 수화시킵니다. 삼출물과 뼈 이식 재료를 철저히 혼합하십시오. 이 혼합물은 이중 생체 물질 운반체 주걱을 사용하여 결합에 배치 될 수 있습니다.



9 티슈 재생 키트 세척 및 멸균

Xpression 상자를 사용하면 일정한 두께의 피브린 막을 쉽게 제작할 수 있습니다. 삼출물은 Xpression 천공 트레이 아래의 Xpression 수집 트레이에서 수집 할 수 있습니다. Xpression 상자에는 L-PRF 플러그 제작 실린더와 포스트 추출 소켓에 쉽게 맞는 L-PRF 플러그를 제작하기위한 피스톤이 포함되어 있습니다.



Xpression 가중 커버



Xpression 압축 판



Xpression 수집 트레이의
Xpression 천공 트레이

Xpression 상자 및 보조기구는 멸균 상태로 제공되지 않습니다. 최초 멸균 전에 운송 재료를 제거하고 버립니다. 매번 사용하기 전에 Xpression 상자와 보조기구를 청소하고 소독하십시오.

각 세척 및 멸균주기 전에 Xpression 상자를 분해하여 이물질 캡슐화, 재료 변색 및 / 또는 구성 요소의 부적절한 건조를 피하십시오. 세척 및 멸균을 위해 L-PRF 플러그 제작 실린더 및 피스톤 그로밋을 Xpression 천공 트레이에서 제거하지 마십시오.

청소: (1) 부드러운 강모 브러시와 Hu-Friedy 's Enzymax®와 같은 광범위한 스펙트럼 세척제 또는 소독제를 사용하여 Xpression 상자 구성 요소 및 보조기구에서 눈에 보이는 부스러기를 제거하십시오. 철저히 씻어. (2) Xpression 상자 구성 요소 및 보조기구를 동일한 크기의 적절한 크기의 용기에 넣고 10 분 동안 초음파 처리합니다. 철저히 씻어. (3) Xpression box 구성품 및 보조기구를 이소 프로필 알코올로 헹구어 비누 잔류 물과 미네랄을 제거합니다. (4) 보푸라기가없는 수건으로 Xpression 상자 구성품 및 보조기구를 닦아내고 완전히 건조시킵니다. 사용 지침에 사용 된 세척제의 라벨을 참조하십시오.

살균: (1) 재 조립 된 Xpression 박스와 보조기구를 FDA 에서 승인 한 멸균 백 또는 랩에 넣습니다. (2) 다음과 같은 적격 멸균주기 중 하나를 수행하십시오.

살균 방법	온도	노출 시간	최소 건조 시간
진공 전 증기 (ANSI/AAMI ST79)	132°C (270°F)	4 의사록	20-30의사록
진공 전 증기 (UK DoH Health Technical Memorandum 01-01)	134°C (273°F)	3 의사록	20-30의사록

주의! 부적절한 청소는 부적절한 멸균으로 이어질 수 있습니다. 오토 클레이브 중 Xpression 박스 구성품 및 보조기구를 완전히 건조시키지 않으면 수분이 남아 변색 및 산화가 발생할 수 있습니다. 과산화수소 또는 기타 산화제를 사용하면 Xpression 상자 구성 요소 및 보조기구의 표면이 손상 될 수 있습니다. 장치가 올바른 작동 상태를 유지하도록 오토 클레이브 장비를 정기적으로 테스트, 청소 및 교정하는 것이 좋습니다.

10 중앙 청소 및 유지 관리

장치가 오염될 수 있습니다. 세척하기 전에 주전원 플러그를 잡아 당기십시오. 원심분리기, 로터 및 부속품은 행굼 기계에 세척해서는 안 됩니다. 이들은 손으로만 세척할 수 있고 액체로 소독할 수 있습니다. 수온은 20 ~ 25°C 이어야 합니다. pH가 5-8 이고 가성 알칼리, 과산화물, 염소 화합물, 산 및 알칼리 용액을 포함하지 않는 세제 / 소독제 만 사용할 수 있습니다. 세척제 또는 소독제를 통해 부식을 방지하기 위해 세척제 또는 소독제 제조업체의 응용 가이드에 주의해야 합니다.

불순물이 부착되어 부식을 방지하기 위해 필요한 경우 비누 또는 중성 세제와 젖은 천을 사용하여 원심 분리기 하우징과 원심 분리 챔버를 정기적으로 청소하십시오. 적합한 세제의 성분은 비누, 음이온 성 계면 활성제 및 비이온성 계면 활성제를 포함한다. 세제를 사용한 후 젖은 천으로 닦아 세제 잔여물을 제거합니다. 세척한 후 즉시 표면을 건조시켜야 합니다. 응축수가 형성될 경우 흡수력이 좋은 천으로 닦아 원심분리기 챔버를 건조시킵니다. 각 세척 후 고무 관리 제품 또는 톨컴 파우더로 원심분리기 챔버의 고무 밀봉부를 가볍게 문지릅니다. 원심 분리 챔버의 손상 여부를 점검해야 합니다. 안전과 관련한 손상이 발견될 경우 원심분리기를 더 이상 작동시킬 수 없습니다. 이 경우 고객 서비스 센터에 문의하십시오.

표면 소독의 경우 감염성 물질이 원심 챔버로 침투하면 즉시 소독해야 합니다. 적합한 소독제의 성분은 에탄올, n- 프로판올, 에틸 헥산 올, 음이온 성 계면 활성제 및 부식 억제제를 포함한다. 소독제를 사용한 후 젖은 천으로 닦아 소독제 잔여물을 제거합니다. 소독한 후 즉시 표면을 건조시켜야 합니다.

방사성 오염 물질을 제거하기 위해서는 방사성 오염 물질 제거제로 표시되어야 합니다. 방사성 오염물을 제거하기 위한 적합한 세제의 성분은 음이온 성 계면 활성제, 비이온성

계면 활성제, 다가 에탄올을 포함한다. 방사능오염물을 제거한 후 젖은 천으로 닦아 약품 잔여물을 제거합니다. 방사능오염물을 제거한 후 표면을 직접 건조시켜야 합니다.

11 로터 및 부속품청소 및 유지 관리

부식 및 해당 물질 변경 방지를 위해 비누 또는 연성 세척제 및 젖은 천을 사용해 로터 및 부속품을 정기적으로 세척해야 합니다. 최소 일주일에 한 번 세척을 권장합니다. 오염물을 즉시 제거해야 합니다.

적합한 세제의 성분은 비누, 음이온 성 계면 활성제 및 비이온성 계면 활성제를 포함한다. 세제를 사용한 후 물로 헹궈 세제 잔여물을 제거하거나 (원심분리기 외부에서만) 젖은 천으로 닦으십시오. 세척 후 로터 및 부속품을 즉시 건조시켜야 합니다. 로터 및 부속품에 마모 및 부식 손상이 있는지 주 단위로 확인하십시오. 로터 및 부속품에 마모나 부식 징후가 있는 경우 더 이상 사용해서는 안 됩니다. 로터가 견고하게 고정되었는지 주 단위로 확인하십시오. 감염 가능성이 있는 물질이 로터나 부속품에 묻을 경우 적절하게 소독해야 합니다.

적합한 소독제의 성분은 에탄올, n-프로판올, 에틸 헥산 올, 음이온 성 계면 활성제 및 부식 억제제를 포함한다. 소독제를 사용한 후 물로 헹궈 소독제 잔여물을 제거하거나 (원심분리기 외부에서만) 젖은 천으로 닦으십시오. 소독 후 즉시 로터 및 부속품을 건조시켜야 합니다.

방사성 오염 물질 제거를 위해, 제제는 방사성 오염 물질 제거제로 특별히 표시되어야 합니다. 방사성 오염 물질을 제거하기 위한 적합한 물질의 성분은 음이온 성 계면 활성제, 비이온성 계면 활성제 및 다가 에탄올을 포함한다. 방사능오염물을 제거한 후 물로 헹궈 약품 잔여물을 제거하거나 (원심분리기 외부에서만) 젖은 천으로 닦으십시오. 방사능오염물을 제거한 후 로터 및 부속품을 직접 건조시켜야 합니다.

로터를 121oC / 250oF 에서 20 분 동안 고압 멸균하고 적절하게 건조시킬 수 있다. 10 회 고압멸균 사이클 후 안전상의 이유로 로터를 교체해야 합니다. 고압 처리는 플라스틱의 노화 과정을 가속화하며 변색을 유발할 수 있습니다. 고압 멸균 후 로터가 다시 사용하기

전에 주변 온도까지 냉각 될 때까지 기다리십시오. 열균 정도에 대한 설명은 세부적으로 제공되지 않습니다.

로터의 사용 기간은 50,000 회 작동주기 (원심 분리 작동) 또는 5 년 중 더 빠른 것으로 제한됩니다. 허용 가능한 최대 작동 사이클 수는 로터에서 확인할 수 있습니다. 안전상의 이유로, 허용되는 최대 작동 사이클 수 (위에 표시됨) 에 도달할 경우 로터를 더 이상 사용할 수 없습니다. 장치에는 작동 사이클 (원심분리 작동) 을 카운트하는 사이클 카운터가 갖춰져 있습니다.

혈액 튜브 골절의 경우 모든 깨진 부분과 혈액을 완전히 제거해야 합니다. 원심 분리는 지시 된대로 철저히 청소해야 하며 회 전자의 플라스틱 슬리브뿐만 아니라 고무 인서트도 교체해야 합니다.

ARCHIVED DOCUMENT

12 중앙 집종식기술 사양

모형 유형	IS220Z	IS110Z
주전원 전압(± 10%)	200 - 240 V 1~	100 - 127 V 1~
주전원 주파수	50 - 60 Hz-	50 - 60 Hz
연결된 로드	100 VA	100 VA
전류 소비	0.5 A	1.0 A
생산 능력	8 x 10 ml	
최대 허용 밀도	1.2 kg/dm ³	
최고 속도(RPM)	6,000	
상대원심력(RCF)	3,461	
운동에너지	750 Nm	
설치 장소	실내 전용	
고도	해발 최대 2,000 m	
작동 주위 온도	5° C ~ 40° C	
작동을위한 상대 습도	최대 31°C 온도에서 최대 상대 습도 80%, 40°C 의 상대 습도에서 선형으로 50% 감소.	
초과 전압 카테고리	II	
오염도	2	
장치 보호 등급	I	
	폭발 위험 지역에서 사용하기에 적합하지 않습니다.	
방출 간섭, 간섭 내성	EN / IEC 61326-1, 등급 B	FCC 등급 B
잡음 레벨(로터에)	≤ 50 dB(A)	
원심 분리기 폭	261 mm	
원심 분리기 깊이	353 mm	
원심 분리기 높이	228 mm	
원심 분리기 무게	약 9 kg	

13 중앙 작동 지침

나사 2 (a) 개와 스페이스 2 (b) 개로 구성된 운송 고정 장치를 반드시 제거해야 합니다. 장치를 운반하기 전에 다시 설치해야 하기 때문에 운반 고정 장치를 안전한 곳에 두십시오. 설치된 운반 고정 장치를 통해서만 장치를 운반할 수 있습니다. 운반 중 장치 손상을 보호하기 위해 모터를 제자리에 고정합니다. 장치를 작동할 때 이 운반 고정 장치를 제거해야 합니다.

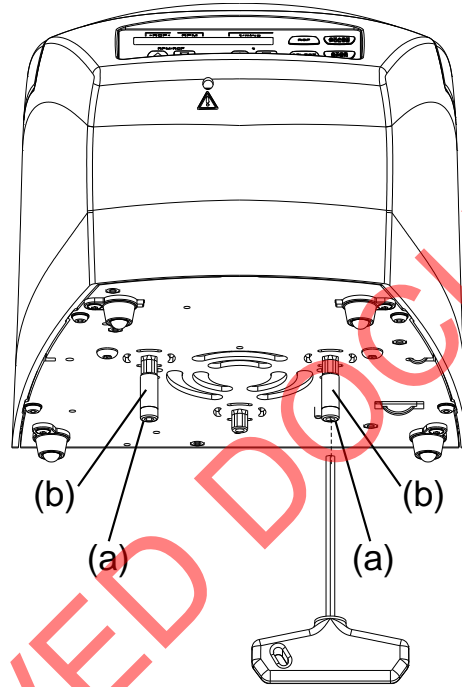

13.1 초기 작동

- 원심 분리기 하단에서 운송 고정 장치를 제거합니다.
- 원심분리기를 적절한 장소에 안정되게 수평으로 배치하십시오. 원심 분리기가 작동 중이면 원심 분리기 주변의 사람, 위험한 물질 또는 물체가 300mm의 안전 한계 내에 있지 않아야 합니다.
- 통풍구 입구를 막아서는 안 됩니다. 원심분리기 입구 및 통풍구 슬롯에서 300 mm의 거리를 유지해야 합니다.
- 주전원 전압이 타이프 플레이트 설명과 일치하는지 확인하십시오.
- 전원 코드로 원심분리기를 표준 주전원 소켓에 연결하십시오.
- 주전원 스위치 켜기

- 원심 분리기 모델 유형, 소프트웨어 버전 및 마지막으로 사용한 원심 분리 데이터가 패널에 표시됩니다.
- 뚜껑이 닫힌 경우 "Open the lid(뚜껑을 여십시오)" 메시지가 표시됩니다. 이 경우에 뚜껑을 열면 구성 데이터가 표시됩니다.

13.2 CENTRIFUGE LID 열기 및 닫기

원심분리기가 켜지고 로터가 움직이지 않는 경우에만 뚜껑을 열 수 있습니다. 원심분리 작동 후 사이클 카운터를 활성화할 경우 뚜껑을 여는 동안 잔여 실행 사이클 수(원심분리 작동)가 간략하게 표시됩니다.



뚜껑을 열려면 다음 키를 누르십시오 . 모터로 뚜껑을 잠금 해제합니다.  뚜껑이 잠금 해제되었음을 나타냅니다.



손가락을 이용해 뚜껑 및 하우징 사이에 닿지 마십시오. 닫힌 뚜껑에 힘을 밀치지 마십시오.

덮개를 닫으려면 덮개의 앞쪽 가장자리를 가볍게 누르십시오.  뚜껑이 잠겨 있음을 나타냅니다.



13.3 비상 잠금 해제

정전이 있을 경우 모터로 뚜껑을 잠금해제할 수 없습니다. 손으로 비상 잠금 해제를 수행해야 합니다. 긴급 상황에서 잠금을 해제하려면 전원 스위치를 끄십시오 (스위치 설정 "0"). 뚜껑 내 창을 살펴보고 로터가 정지되었는지 확인하십시오. 로터가 정지될

때에만 뚜껑을 여십시오. 알렌 키를 보어 (A) 에 수평으로 삽입하고 뚜껑이 열릴 때까지 시계 반대 방향 (왼쪽) 으로 조심스럽게 돌리십시오. 주의! 육각 렌치를 시계 방향 (오른쪽)으로 돌리면 잠금 시스템이 손상 될 수 있습니다. 보어에서 알렌 키를 잡아 당기십시오.

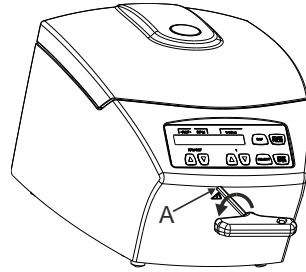

13.4 로터 설치 및 제거

로터를 제거하려면 알렌 렌치(납품 시 포함됨)를 이용해 시계 반대 방향으로 돌리고 리프팅 압력 포인트까지 돌려 로터의 클램핑 너트를 푸십시오. 리프팅 압력 포인트를 극복한 후 모터 샤프트의 콘에서 로터가 해제됩니다. 모터 샤프트에서 로터를 들어올릴 수 있을 때까지 클램핑 너트를 회전시킵니다. 모터 샤프트에서 로터를 들어올립니다.

로터를 설치하려면 모터 샤프트(A) 및 로터의 보어를 세척한 다음 모터 샤프트에 그리스를 얇게 바르십시오. 모터 샤프트 및 로터 사이의 오물은 로터가 완벽한 시트를 갖지 못하게 하며 불안정하게 작동되도록 합니다. 로터를 모터 샤프트 위로 수직으로 놓으십시오. 로터를 가동할 때 로터의 마킹 빔(B)은 모터 샤프트의 두 표면(C)과 평행해야 합니다. 시계 방향으로 돌려 알렌 렌치(납품 시 포함됨)를 이용해 로터의 클램핑 너트를 조이십시오. 견고하게 고정되었는지 로터를 확인하십시오.

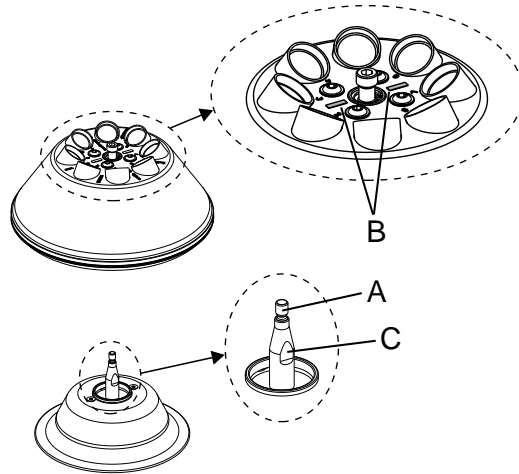

대칭적으로 로터를 로드해야 합니다. 혈액 튜브는 모든 로터 위치에 고르게 분포되어야 합니다.

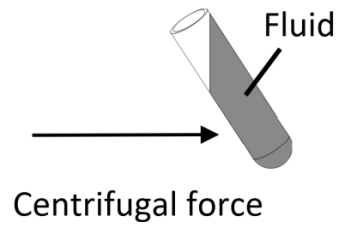
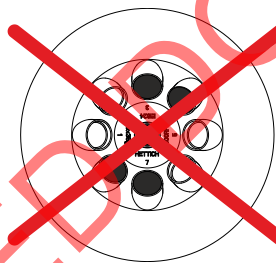
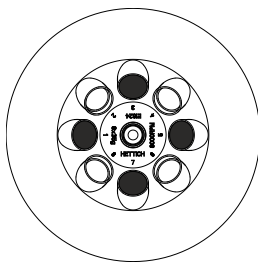

로터가 균일하게 로드됨 로터가 균일하게 로드되지
 않음
허용되지 않음!

혈액 튜브는 원심 분리기 외부에서만 채울 수 있습니다. 혈액 튜브의 최대 충전량은 튜브 자체에 명시되어 있으며 로터에 표시된 최대 무게를 초과해서는 안 됩니다. 원심분리기 용기는 원심분리기가 작동 중일 때 액체가 방출되지 않는 경우에만 채울 수 있습니다. 로터를 로드할 때 액체가 로터 또는 원심분리 챔버에 들어갈 수 없습니다. 원심 분리 용기 내에서 무게 차이를 가능한 한 최소화하기 위해, 혈액 튜브의 일정한 충전 수준을 권장합니다.

13.5 디스플레이 요소 설명

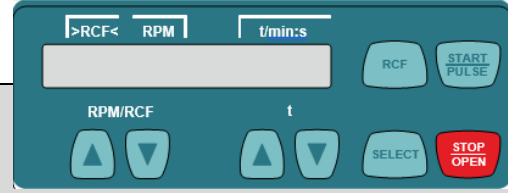

상징 / 패널 키	기술
	뚜껑 잠금 해제됨.
	뚜껑 잠금 처리됨.
	회전 디스플레이. 로터가 회전하면 회전 디스플레이가 시계 방향으로 회전합니다.
RPM/RCF 	직접 속도를 입력합니다. 키를 계속 누를 경우 속도가 증가하면서 값이 변합니다.
t 	런타임을 직접 입력합니다. 1 초에서 최대 1 분에 이르는 단계 및 1 분에서 시작하는 1 분 단계로 조정 가능합니다. 원심분리. 키를 계속 누를 경우 속도가 증가하면서 값이 변합니다.
	개별 매개 변수를 활성화하려면. 키를 누를 때마다 다음 파라미터가 활성화됩니다. "MACHINE MENU" (장비 메뉴) 를 불러 오려면 키를 8 초 동안 누르십시오. "Machine Menu" 에서 메뉴 "-> Info(정보)", "-> Settings(설정)" 및 "-> Time & Cycles (시간 및 사이클)"를 선택하십시오. 메뉴에서 앞으로 스크롤하십시오.
	속도 표시 (RPM)와 상대 원심력 표시 (RCF) 간을 전환합니다. RCF 값은 화살표 <사이에 표시됩니다.
	원심분리 작동을 시작합니다. 단기 원심분리. 키를 계속 누르는 한 원심분리가 작동됩니다. 메뉴를 선택하려면 "->Info", "->Settings" 및 "->Time & Cycles".
	원심분리 작동을 마칩니다. 미리 선택한 브레이크 단계로 로터가 작동됩니다. 키를 두 번 누르면 비상 정지가 트리거됩니다. 뚜껑을 잠금 해제합니다.
t/min (t/분)	런타임. 1 - 99 분, 1 분 단계로 조정 가능.

t/sec (t/초)	런타임. 1 - 59 초, 1 초 단계로 조정 가능. 지속 작동 "--:--". 파라미터 t/min 및 t/sec 를 영점으로 설정하십시오.
RPM	속도. 200 rpm 의 숫자값에서 로터의 최대 속도까지 설정할 수 있습니다. 10 단계로 조정 가능.
>RCF<	상대원심력. 200 rpm 및 최대 로터 속도 사이 속도를 갖는 숫자값을 설정할 수 있습니다. 1 단계로 조정 가능. RCF 디스플레이 (>RCF<)가 활성화될 경우 상대원심력(RCF)만 입력할 수 있습니다. 상대원심력(RCF)은 원심분리 반경(RAD)에 좌우됩니다. RCF 를 입력한 후에 올바른 원심분리 반경이 설정되었는지 확인하십시오.
RAD/mm	원심분리 반경. 10 mm ~ 250 mm, 1 mm 단계로 조정 가능. RCF 디스플레이(>RCF<)가 활성화될 경우 원심분리 반경만 입력할 수 있습니다.
~_DEC	브레이크 단계. fast(빠른) = 짧은 런아웃 타임, slow(느린) = 긴 런아웃 타임.

13.6 원심분리 파라미터 직접 입력

이전에 ▲ ▼ 키를 입력할 필요 없이 해당 키  를 이용해 속도(RPM), 상대원심력(RCF), 원심분리 반경(RAD) 및 런타임을 직접 입력할 수 있습니다. 설정 원심분리 파라미터는 원심분리 작동을 시작한 후에만 보관됩니다.

속도(RPM):

 키를 눌러 필요에 따라 RPM 디스플레이(RPM)를
활성화합니다.

RPM/RCF 해당 키를 이용해 원하는 값을 설정합니다.



예:

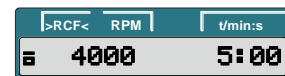
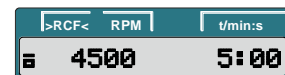

상대원심력(RCF) 및 원심분리 반경(RAD):

예:

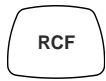

키를 눌러 필요에 따라 RCF 디스플레이(>RCF<)를 활성화합니다.



해당 키를 이용해 원하는 RCF 값을 설정합니다.

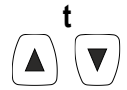

필요에 따라 해당 키를 이용해 원하는 원심분리 반경을 설정합니다.



런타임:

최대 1 분까지 1 초 단계로 런타임을 설정할 수 있고 1 분에서 시작하여 1 분 단계로만 설정할 수 있습니다.

연속 작동을 설정하기 위해 파라미터 **t/min**(t/분) 및 **t/sec**(t/초) 를 영점으로 설정해야 합니다. 시간 디스플레이에서(t/min:s), "---:--"이 나타납니다.



예:

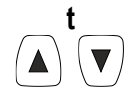

해당 키를 이용해 원하는 값을 설정합니다.

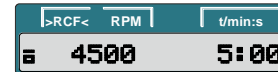

13.7 "SELECT(선택)" 키를 이용해 구성 파라미터 입력

분 및 초 단위로 런타임을 설정할 수 있습니다(파라미터 **t/min**(t/분) 및 **t/sec**(t/초)).

연속 작동을 설정하기 위해 파라미터 **t/min**(t/분) 및 **t/sec**(t/초) 를 영점으로 설정해야 합니다. 시간 디스플레이 에서 (t/min:s), "---:--"이 나타납니다.



상대 원심 가속도(RCF)는 원심분리 반경(RAD)에 좌우됩니다. RCF 입력 중 설정 원심분리 반경이 표시됩니다. 선택 후 8 초간 또는 파라미터 입력 중 키를 누르지 않을 경우 이전 값이 디스플레이에 표시됩니다. 그런 다음 파라미터를 다시 입력해야 합니다.

버튼을 누르면 설정이 저장됩니다. 여러 파라미터를 입력할 경우 마지막 파라미터를 설정한 후 **START PULSE** 키를 눌러야 합니다. 언제든지 **STOP OPEN** 키를 눌러 파라미터 입력을 취소할 수 있습니다. 이 경우에 설정이 저장되지 않습니다.

예: 디스플레이(RPM) 예: 디스플레이 (>RCF<)

RCF 키를 눌러 필요에 따라 RPM 디스플레이 (RPM) 또는 RCF 디스플레이 (>RCF<)를 활성화합니다.

SELECT 키를 누르십시오.
t/min : 런타임, 분.

t 키를 이용해 원하는 값을 설정합니다.

SELECT 키를 누르십시오.
t/sec : 런타임, 초.

t 키를 이용해 원하는 값을 설정합니다.

RCF 키를 누르십시오.
RPM : 속도.
RAD/mm : 원심분리 반경.
RCF 디스플레이(>RCF<) 가 활성화될 경우 원심분리 반경만 표시 및 입력할 수 있습니다.

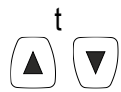

해당 키를 이용해 원하는 값을 설정합니다.



키를 누르십시오.



R : 원심분리 반경.
RCF : 상대원심력



해당 키를 이용해 원하는 값을 설정합니다.



키를 누르십시오.



~\DEC: 브레이크 단계.
fast(빠른) : 짧은 런아웃 타임.
slow(느린) : 긴 런아웃 타임.



해당 키를 이용해 원하는 값을 설정합니다.



버튼을 눌러 설정을 저장합니다.

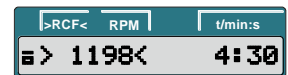

ARCHIVED DOCUMENT



13.8 제어판 디스플레이

각 원심분리 작동 후 뚜껑이 잠금 해제되는 동안 잔여 실행 사이클 수(원심분리 작동)가 간략하게 표시됩니다.

예:  >RCF< RPM t/min:s
RemCycles= 16703

로터 하중 내에서 허용 중량 차이를 초과 한 경우 시동 중에 원심 분리 실행이 중단되고 "IMBALANCE"가 표시됩니다.

예:  >RCF< RPM t/min:s
IMBALANCE

 키를 눌러 언제든지 원심분리 작동을 무산시킬 수 있습니다. 원심분리 작동 중 원심분리 파라미터를 선택 및 변경할 수 있습니다. 하지만 변경된 값은 현재 원심분리 작동에만 적용되고 저장되지 않습니다.  키를 이용해 언제든지 RPM 디스플레이(RPM) 및 RCF 디스플레이(>RCF<) 간에 토글할 수 있습니다. RCF 디스플레이(>RCF<)가 작동할 경우 원심분리 반경을 입력해야 합니다. 그런 다음 뚜껑을 연 후에만 원심분리기의 추가 작동이 가능합니다.

작동 오류 및 오작동이 표시됩니다.

예:  >RCF< RPM t/min:s
Open the lid

13.9 사전설정 시간을 통한 원심분리

키를 눌러 필요에 따라 RPM 디스플레이(RPM) 또는 RCF 디스플레이(>RCF<)를 활성화합니다.

↓

원하는 원심분리 파라미터를 입력합니다

↓

키를 눌러 원심분리 작동을 시작합니다. 원심분리 작동 중 로터 속도 또는 결과적인 RCF 값과 잔여 시간이 표시됩니다.

↓

시간 경과 후 또는 **STOP OPEN** 키를 눌러 원심분리 작동이 무산된 경우 설정 브레이크 단계와 함께 런아웃이 발생합니다. 브레이크 단계 ~f가 표시됩니다.

예: 디스플레이(RPM) 예: 디스플레이(>RCF<)



13.10 연속 작동

키를 눌러 필요에 따라 RPM 디스플레이(RPM) 또는 RCF 디스플레이(>RCF<)를 활성화합니다.

↓

원하는 원심분리 파라미터를 입력합니다. 파라미터 t/min(t/분) 및 t/sec(t/초) 를 영점으로 설정합니다

↓

예: 디스플레이(RPM) 예: 디스플레이(>RCF<)



START PULSE 키를 눌러 원심분리 작동을 시작합니다. 원심분리 작동 중 로터 속도 또는 결과적인 RCF 값과 잔여 시간이 표시됩니다.



STOP OPEN 키를 눌러 원심분리 작동을 종료합니다. 설정 브레이크 단계와 함께 런아웃이 발생합니다. 브레이크 단계 ~f 가 표시됩니다.



13.11 단기 원심분리

RCF 키를 눌러 필요에 따라 RPM 디스플레이(RPM) 또는 RCF 디스플레이(>RCF<)를 활성화합니다.

예: 디스플레이(RPM) 예: 디스플레이(>RCF<)



원하는 원심분리 파라미터를 입력합니다



키를 계속 누릅니다. 원심분리 작동 중 로터 속도 또는 결과적인 RCF 값과 경과 시간이 표시됩니다.



다시 키에서 손을 떼 원심분리 작동을 종료합니다.



설정 브레이크 단계와 함께 런아웃이 발생합니다. 브레이크 단계 ~f 가 표시됩니다.

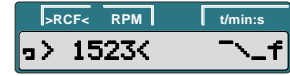

13.12 비상 정지

키를 두 번 누르십시오.
비상 정지 중 "fast(빠른)"



브레이크 단계와 함께 런아웃이 발생합니다(짧은 런아웃 타임).
브레이크 단계 ~f 가 표시됩니다.

예: 디스플레이(RPM) 예: 디스플레이(>RCF<)

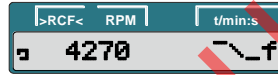

13.13 사이클 카운터

원심분리기에는 작동 사이클(원심분리 작동)을 카운트하는 사이클 카운터가 갖춰져 있습니다. 각 원심분리 작동 후 뚜껑이 잠금 해제되는 동안 잔여 실행 사이클 수(원심분리 작동)가 간략하게 표시됩니다.





허용 가능한 최대 로터 작동 사이클 수를 초과할 경우 원심분리 작동을 시작할 때마다 다음이 표시되고 원심분리 작동을 재시작해야 합니다. 안전상의 이유로 로터를 새 로터로 즉시 교환해야 합니다. 로터가 교환된 후 사이클 카운터를 "0"으로 재설정해야 합니다





13.14 사이클 카운터를 영점으로 재설정



로터를 교환한 후 사이클 카운터를 다시 영점으로 재설정해야 합니다. 우선 로터를 새 로터로 교환한 경우에만 사이클 카운터를 영점으로 재설정할 수 있습니다. 로터를 정지한 상태로 다음과 같이 사이클 카운터를 재설정할 수 있습니다.  키를 눌러 언제든지 해당 절차를 무산시킬 수 있습니다. 이 경우에 설정이 저장되지 않습니다.

 8초간 버튼을 누르십시오. 

↓

 다음이 표시될 때까지 키를 누르십시오. 

↓



 키를 누르십시오. 예: 

↓

다음이 표시될 때까지 키를 누르십시오. 

 Cyc sum(사이클 합계): 완료된 실행 사이클 수.

↓



 키를 누르십시오. 

↓

키를 누르십시오. 

 완료된 실행 사이클 수를 영점으로 재설정합니다.

↓

 버튼을 눌러 설정을 저장합니다. 

↓



키를 두 번 눌러"-> Time & Cycles(시간 및 사이클)" 메뉴에서 나가거나 세 번 눌러 "* MACHINE MENU (기계 메뉴) *"에서 나갑니다.



예:



13.15 설정 및 질의

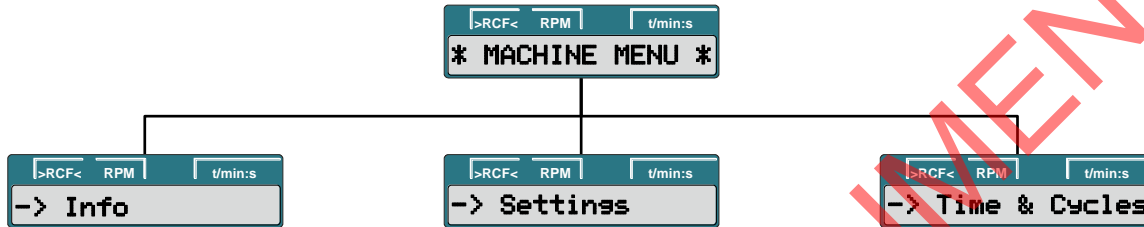

질의:

- 시스템 정보

설정:

- 음향 신호
- 원심분리 작동 후 뚜껑에 대한 자동 잠금 해제
- 배경 조명의 자동 꺼짐
- 원심분리 작동 종료 후 광학 신호

질의:

- 작동 시간
- 완료된 원심분리 작동 수

설정:

- 사이클 카운터

13.16 스템 정보 질의하기

다음 시스템 정보와 관련해 질의할 수 있습니다:

- 장치 모델,
- 장치 프로그램 버전,
- 장치 유형 번호,
- 장치 제조일,
- 장치 일련번호,
- 주파수 변환기 유형,
- 주파수 변환기 프로그램 버전

로터를 정지한 상태로 다음과 같이 질의할 수 있습니다.  키를 눌러 언제든지 해당 절차를 무산시킬 수 있습니다.

 8초간 버튼을 누르십시오.

>RCF< RPM t/min:s
* MACHINE MENU *

↓
 키를 누르십시오.

>RCF< RPM t/min:s
-> Info

↓
 키를 누르십시오.
장치 모델.

>RCF< RPM t/min:s
BOECO SC-8

↓
 키를 누르십시오.
장치 프로그램 버전.

예:
>RCF< RPM t/min:s
CP FW= V02.00-05

↓
 키를 누르십시오.
Type#1(유형#1) : 장치 유형 번호.

예:
>RCF< RPM t/min:s
Type#: 1800-13

↓
 키를 누르십시오.
Type#2(유형#2) : 여기에 "Type#1" 디스플레이 필드보다 더 많은 위치가 있는 경우 유형 번호 지속.

예:
>RCF< RPM t/min:s
Type#2:

↓
 키를 누르십시오.
장치 제조일.

예:
>RCF< RPM t/min:s
Date: 2017-09-12

↓
 키를 누르십시오.
장치 일련번호.

예:
>RCF< RPM t/min:s
Serial#: 0016234



키를 누르십시오.
주파수 변환기 유형.

예:



키를 누르십시오.
주파수 변환기 프로그램 버전.

예:



키를 두 번 눌러"-> Info(정보)"
메뉴에서 나가거나 세 번 눌러"*
MACHINE MENU기계 메뉴) * "에서
나갑니다.

예:

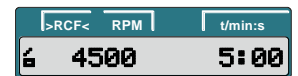

13.17 음향 신호

음향 신호는 다음과 같이 울립니다: (1) 2초 간격으로 오작동이 발생한 이후. (2) 로터가 30분 간격으로 정지하고 원심분리 작동이 종료된 후. 어떠한 키를 눌러도 음향 신호가 종료됩니다. 로터가 정지된 경우 음향 신호를 다음과 같이 설정할 수 있습니다.  키를 눌러 언제든지 해당 절차를 무산시킬 수 있습니다. 이 경우에 설정이 저장되지 않습니다.



8초간 버튼을 누르십시오.



다음에 표시될 때까지 키를
누르십시오.



키를 누르십시오.



End beep(종료 신호음) : 원심분리
작동 종료 후 음향 신호.
off(꺼짐) : 신호 비활성화됨.
on(켜짐) : 신호 활성화됨.



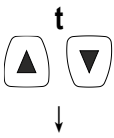

키를 이용해 **off** 또는 **on**으로
설정합니다.



키를 누르십시오.



Error beep(오류 신호음) : 오작동이
발생한 후 음향 신호.



off(꺼짐) : 신호 비활성화됨.

on(켜짐) : 신호 활성화됨.

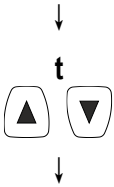

키를 이용해 **off** 또는 **on**으로
설정합니다.

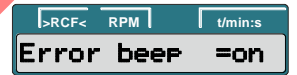

키를 누르십시오.



Beep volume(신호음 볼륨) : 음향
신호 볼륨.



min(최소) : 작은

mid(중간) : 중간

max(최대) : 큰

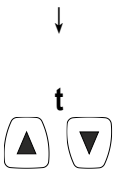

키를 이용해 **min, mid** 또는 **max**로
설정하십시오.

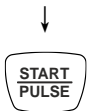

버튼을 눌러 설정을 저장합니다.



키를 한 번 눌러"-> Settings (설정)"
메뉴에서 나가거나 두 번 눌러"*
MACHINE MENU (기계 메뉴) *



예:

13.18 원심분리 작동 종료 후 광학 신호

원심분리 작동 후 디스플레이의 백라이트가 점멸하며 원심분리 작동이 완료되었다는 것을 시각적으로 표시합니다. 로터가 정지될 때 광학 신호를 켜거나 끌 수 있습니다.

 키를 눌러 언제든지 해당 절차를 무산시킬 수 있습니다.

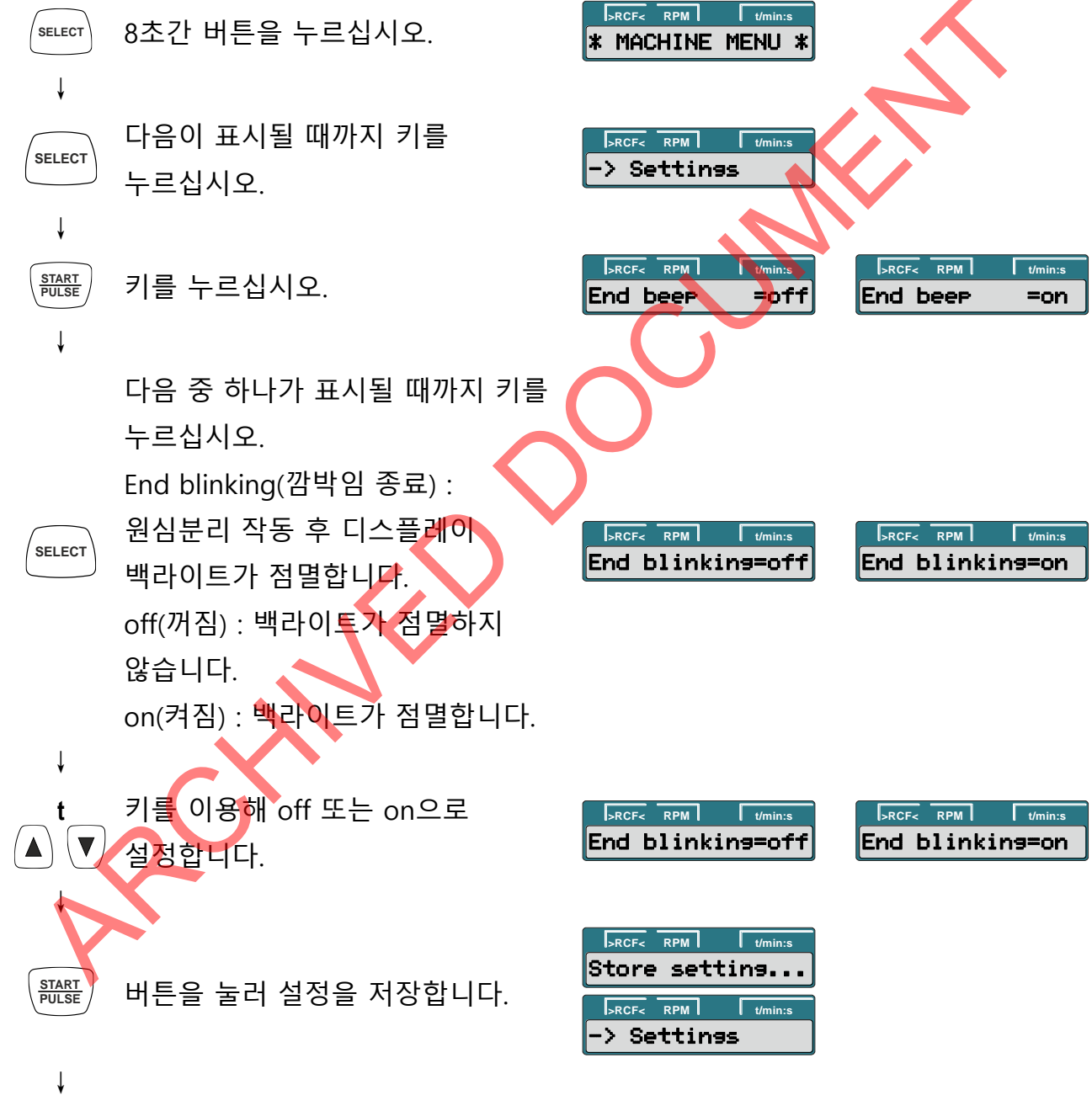



키를 한 번 눌러"-> Settings (설정)"
메뉴에서 나가거나 두 번 눌러"*
MACHINE MENU (기계 메뉴) *"에서
나갑니다.



예:



13.19 원심분리 작동 후 뚜껑에 대한 자동 잠금 해제

원심분리 작동 후 뚜껑이 자동으로 잠금 해제되는지 유무를 설정할 수 있습니다.

로터를 정지한 상태로 다음과 같이 설정할 수 있습니다.  키를 눌러 언제든지 해당 절차를 무산시킬 수 있습니다. 이 경우에 설정이 저장되지 않습니다.



8초간 버튼을 누르십시오.



다음에 표시될 때까지 키를
누르십시오.



키를 누르십시오.



다음 중 하나가 표시될 때까지 키를
누르십시오.

Lid AutoOpen(뚜껑 자동 열림) :

원심분리 작동 후 뚜껑에 대한 자동
잠금 해제.



off(꺼짐) : 뚜껑이 자동으로 잠금
해제되지 않습니다.



on(켜짐) : 뚜껑이 자동으로 잠금
해제됩니다.



키를 이용해 **off** 또는 **on**으로
설정합니다.





버튼을 눌러 설정을 저장합니다.



키를 한 번 눌러 "-> Settings" 메뉴에서 나가거나 두 번 눌러 "* MACHINE MENU (기계 메뉴) *" 에서 나갑니다.



예:



13.20 디스플레이 백라이트

에너지 절약을 위해, 원심분리 작동 후, 2분 후에 디스플레이 백라이트가 꺼지도록 설정할 수 있습니다. 로터를 정지한 상태로 다음과 같이 설정할 수 있습니다.  키를 눌러 언제든지 해당 절차를 무산시킬 수 있습니다. 이 경우에 설정이 저장되지 않습니다.



8초간 버튼을 누르십시오.



다음에 표시될 때까지 키를 누르십시오.



키를 누르십시오.



다음 중 하나가 표시될 때까지 키를 누르십시오.

Power save(절전) : 백라이트 자동 전원 차단.



off(꺼짐): 자동 전원 차단 비활성화됨.

on(켜짐) : 자동 전원 차단 활성화됨.



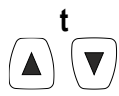

키를 이용해 **off** 또는 **on**으로 설정합니다.



버튼을 눌러 설정을 저장합니다.



키를 한 번 눌러 "-> Settings (설정)" 메뉴에서 나가거나 두 번 눌러 "* MACHINE MENU (기계 메뉴) *"에서 나갑니다.

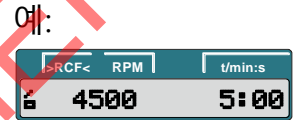

13.21 작동 시간 및 원심분리 작동 수 질의

작동 시간은 내부 및 외부 작동 시간으로 나뉩니다. 내부 작동 시간: 장치가 켜진 총 시간. 외부 작동 시간: 이전 원심분리 작동 총 시간. 로터를 정지한 상태로 다음과 같이 질의할 수 있습니다.  키를 눌러 언제든지 해당 절차를 무산시킬 수 있습니다.



8초간 버튼을 누르십시오.



다음에 표시될 때까지 키를 누르십시오.



키를 누르십시오.

TimeExt (외부 시간) : 외부 작동 시간.

예:



키를 누르십시오.

TimeInt (내부 시간) : 내부 작동 시간.

예:



키를 누르십시오.



Starts (시작) : 모든 원심분리 작동 수.

예:



키를 두 번 눌러"-> Time & Cycles (시간 및 사이클)" 메뉴에서 나가거나 세 번 눌러 "* MACHINE MENU(기계 메뉴) *".에서 나갑니다.



예:



14 장애

아래 결함 테이블을 사용하여 결함을 제거 할 수없는 경우 고객 서비스에 연락하여 원심분리기 유형과 일련 번호를 지정하십시오. 양 번호는 원심분리기의 명판에서 확인할 수 있습니다.

MAINS RESET (주전원 재설정) 를 수행하십시오. 주전원 스위치 끄기 (스위치 위치 "0"). 최소 10초를 기다린 후 주전원 스위치를 다시 켜십시오 ("1").

메시지/장애		원인	해결책
표시 없음		전압 없음 주전원 입력 퓨즈 결함.	<ul style="list-style-type: none"> - 배전 전압 확인. - 주전원 입력 퓨즈를 확인하고 주전원 퓨즈 변경에 대한 지침을 참조하십시오. - 주전원 스위치 켜기.
IMBALANCE (불균형)		로터가 불균일하게 로드됨.	<ul style="list-style-type: none"> - 로터가 정지된 후에 뚜껑을 여십시오. - 로터 로드 확인 - 원심분리 작동을 반복합니다.
MAINS INTER (주전원 간섭)	11	원심분리 작동 중 정전. (원심분리 작동이 완료되지 않았습니다.)	<ul style="list-style-type: none"> - 로터가 정지된 후에 뚜껑을 여십시오. - start/pause버튼 누르기.

MAINS INTERRUPT (주전원 간섭)			- 필요한 경우 원심분리 작동을 반복합니다.
TACHO ERROR (태코미터 오류)	1, 2	작동 중 스피드 임펄스 장애.	- 로터가 정지되었을 때 MAINS RESET (주전원 재설정) 을 수행합니다.
LID ERROR (뚜껑 오류)	4.1 - 4.127	뚜껑 잠금 또는 뚜껑 폐쇄 오류.	
OVER SPEED (과속)	5	너무 빠른 회전	
VERSION ERROR (버전 오류)	12	올바르지 않은 원심분리기 모델 인식됨. 전자장치 오류/결함	
UNDER SPEED (저속)	13	너무 느린 회전	- 로터가 정지되었을 때 MAINS RESET (주전원 재설정) 을 수행합니다.
CTRL ERROR (제어 오류)	22.1, 25.2	전자장치 오류/결함	
CRC ERROR (CRC 오류)	27.1		
COM ERROR (COM 오류)	31 - 36		

FC ERROR (FC 오류)	60, 61.1 - 61.21, 61.64 - 61.142		
FC ERROR (FC 오류)	61.23	속도 측정 오류	<ul style="list-style-type: none"> - 회전 디스플레이가 점등되어 있고 회전하는 한 장치를 끌 수 없습니다. 기호  (잠금처리된 뚜껑)가 표시될 때까지 기다리십시오 (약 120초 후). 그 다음 MAINS RESET (주전원 재설정) 를 수행하십시오.
TACHO ERR (태코미터 오류)	61.22		
FC ERROR (FC 오류)	61.153	전자장치 오류/결함	<ul style="list-style-type: none"> - MAINS RESET (주전원 재설정) 를 수행하십시오. - 제공된 지침에 따라 로터의 하중을 확인하십시오. - 원심분리 작동을 반복합니다.

15 상대원심력 (RCF)

상대원심력 (RCF) 은 중력 (g) 가속도의 배수로 제공됩니다. 단위가 없는 값으로 분리 및 침전 성능을 비교합니다. 상대원심력 (RCF) 은 원심분리 반경 및 분당 회전에 비례합니다. 아래 공식을 사용하여 계산할 수 있습니다:

$$RCF = \left(\frac{RPM}{1000} \right)^2 \times r \times 1,118 \quad \Rightarrow \quad RPM = \sqrt{\frac{RCF}{r \times 1,118}} \times 1000$$

RCF = 상대원심력

RPM = 회전 속도 (분당 회전)

r = 원심분리 반경 (mm 단위) = 회전 축 중앙에서 원심분리기 용기 하단까지거리.

16 운반 및 보관

장치를 운반하기 전에 운반 고정 장치를 설치해야 합니다. 장치 및 부속품은 폐쇄된 건조실에만 보관할 수 있습니다. 장치 및 액세서리를 운송하거나 보관할 때는 다음 조건을 준수해야 합니다.:

주변 온도: -20°C ~ +60°C

상대 습도: 10% ~ 80%, 비응축

17 주전원 입력 퓨즈 교체

전원 스위치를 끄고 장치를 전원에서 분리하여 시작하십시오. 주전원 입력 퓨즈가 있는 퓨즈 홀더 (A) 는 주전원 스위치 옆에 있습니다. 기계 플러그 소켓에서 연결 케이블을 제거하십시오. 퓨즈 홀더 (A) 에 대고 스냅 핏 (B) 을 눌러 제거하십시오. 결함 있는 주전원 입력 퓨즈를 교체하십시오. 제조업체가 제공 한 원심 분리기 유형에 대해 정의 된 정격의 퓨즈 만 사용하십시오. 스냅 핏이 딸깍하고 잠길 때까지 퓨즈 홀더를 재삽입하십시오. 장치를 주전원 공급 장치에 재연결하십시오.

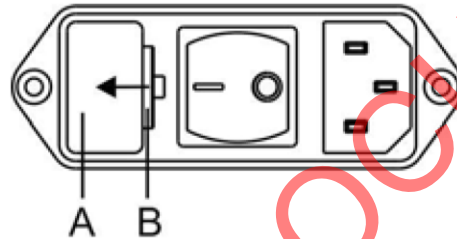

18 장치 반납

장치를 반납하기 전에 운반 고정 장치를 설치해야 합니다. 사람이나 환경, 재료를 보호하기 위해 장치 나 액세서리를 합법적인 제조업체에 반환 할 경우 배송 전에 오염을 제거하고 청소해야 합니다. 법적 제조업체는 오염 된 장치 또는 액세서리를 거부 할 권리가 있습니다. 세척 및 소독 관련 비용은 고객이 부담합니다.

19 폐기

폐기하기 전에 사람, 환경 및 재산 보호를 위해 장치 오염물을 제거하고 세척해야 합니다. 장치를 폐기할 때 해당 법 규정을 따라야 합니다. 가이드라인 2002/96/EC (WEEE) 에 따라 2005년 8월 13일 이후에 제공되는 모든 장치는 생활 폐기물로 폐기할 수 없습니다. 이 장치는 group 8 (의료 장치) 에 속하며 B2B 분야로 분류됩니다. 교차 표시된 쓰레기 기호는 해당 장치를 생활 폐기물로서 폐기할 수 없다는 것을 나타냅니다. 개별 EC 국가의 폐기물 처리 가이드라인은 다를 수 있습니다. 필요할 경우 공급업체에 문의하십시오.



جدول الرموز أدناه هو للإشارة فقط. ارجع إلى ملصق تعبئة المنتج للحصول على الرموز المطبقة.

رمز	وصف الرمز
	تنبيه
	تعليمات استخدام الأجهزة الإلكترونية
	الجهة المصنعة
	تحمل منتجات BioHorizons علامة CE وتفي بمتطلبات توجيه الأجهزة الطبية
	رقم الصنف / المرجع
	رقم الدفعة / التشغيل
	تمنع إعادة الاستخدام
	لا تقم بإعادة التعقيم.
	الاستخدام حسب التاريخ
	يتم التعقيم بواسطة أشعة جاما
	تاريخ الصنع
	تحذير: يحظر القانون الفيدرالي الأمريكي بيع هذه الأجهزة وتوزيعها واستخدامها إلا بواسطة طبيب أسنان أو أحد الأطباء أو بناء على طلبه.

رمز	وصف الرمز
	الوضعية الأولية
	يمنع استخدام المنتج في حالة تلف العبوة
	جهاز طبي
	غير معقم
	الحفاظ على جفاف
	التعامل مع الرعاية
	حدود درجة الحرارة
	بهذه الطريقة إلى الأعلى
	حدود الرطوبة
	تحذير؛ الخطر البيولوجي
	ملاحظات هامة
	مجموعة منفصلة من الأجهزة الكهربائية والإلكترونية.
	مثل معتمد من الاتحاد الأوروبي

1 مؤشرات للاستخدام

الغرض من نظام IntraSpin هو استخدامه للتخضير الآمن والسريع لكتلة الكريات البيض الذاتية والفيبرين الغني بالصفائح الدموية (L-PRF) من عينة صغيرة من الدم في نقطة رعاية المريض. يتم مزج L-PRF مع طعم ذاتي و / أو عظم طعم قبل أن يتم تطبيقه على عيب عظمي لتحسين خصائص المناولة. تعتبر مراقبة جميع المعلومات في تعليمات الاستخدام أيضًا جزءًا من الاستخدام المقصود .

2 موانع

جهاز الطرد المركزي IntraSpin مخصص للغرض المذكور في الاستخدام المقصود للجهاز فقط. يعتبر أي استخدام آخر للجهاز غير مقصود. يُمنع استخدام جهاز الطرد المركزي IntraSpin في وجود حالة أو أكثر من الحالات السريرية التالية: المرضى الذين يعانون من إدمان الكحول أو الاضطرابات النفسية أو اعتلال الدم أو مرض السكري غير المنضبط أو فرط نشاط الغدة الدرقية أو الالتهابات الفموية أو الأورام الخبيثة أو المرضى الذين أصيبوا باحتشاء عضلة القلب في آخر 12 شهر. المرضى الذين يعانون من أمراض جهازية تضعف جهاز المناعة ، مثل الإيدز ، والمرضى الذين يتناولون الأدوية التي من شأنها أن تضعف شفاء موقع الزرع ، والمرضى الذين لديهم تاريخ من سوء أو عدم الامتثال لإجراءات نظافة الفم .

المرضى الذين يشاركون في العلاج المضاد للتخثر. لا يتم استبعاد هؤلاء المرضى من فوائد PRF ، بدلاً من ذلك يجب أن تصيف نقطة الرعاية وقتاً إضافياً إلى جهاز الطرد المركزي حتى يكون الفصل فعالاً للاستخدام.

3 ملاحظات الأمان

- لن تنتظر الشركة المصنعة في أي مطالبة بالضمان ما لم يتم اتباع جميع التعليمات الواردة في هذا الدليل.
- تعليمات التشغيل هي جزء من الجهاز. يجب أن تكون متاحة دائمًا بسهولة. إذا تم إعداد الجهاز في موقع مختلف ، فيجب تزويده بتعليمات التشغيل.
- يجب أن يتم تركيب جهاز الطرد المركزي على قاعدة جيدة ومستقرة .
- قبل استخدام جهاز الطرد المركزي، تحقق جيدًا من القاعدة الدوارة لضمان ثبات موضعه.
- وعند تشغيل جهاز الطرد المركزي، يحظر تواجد أي أشخاص أو مواد خطرة، أو عناصر في حدود هامش السلامة البالغ 300 ملم حول جهاز الطرد المركزي.
- لا يجوز استخدام القواعد الدوارة والمعلقات والملحقات التي تتسبب في حدوث آثار تآكل أو أضرار ميكانيكية أو التي انتهت مدة صلاحيتها.
- يُحظر تشغيل جهاز الطرد المركزي عندما تحتوي غرفة الطرد المركزي على أضرار متعلقة بالسلامة.
- وبالنسبة إلى أجهزة الطرد المركزي التي لا تحتوي على ميزة التحكم في درجة الحرارة، يمكن تسخين غرفة الطرد المركزي وذلك عند زيادة درجة حرارة الغرفة و/أو في حالة الاستخدام المتكرر للجهاز. لذلك، لا يمكن استبعاد تغيير مادة العينة بسبب درجة الحرارة.
- قبل التشغيل الأولي لجهاز الطرد المركزي، يجب عليك قراءة تعليمات التشغيل والانتباه إليها. يُسمح فقط للأفراد الذين قرؤوا تعليمات التشغيل ثم فهموها بتشغيل الجهاز.
- يجب عليك أيضاً اتباع اللوائح المهنية المعترف بها للعمل بطريقة آمنة ومهنية بالإضافة إلى تعليمات التشغيل واللوائح القانونية المتعلقة بمنع الحوادث. يجب قراءة تعليمات التشغيل هذه مع أي تعليمات أخرى تتعلق بمنع الحوادث وحماية البيئة وذلك بناءً على اللوائح الوطنية للبلد الذي سيتم فيه استخدام الجهاز.
- يتحمل المستخدم مسؤولية تلبية المتطلبات الخاصة بكل بلد فيما يتعلق بالسلامة المهنية المرتبطة باستخدام أجهزة الطرد المركزي في أماكن العمل المنصوص عليها لهذا الغرض.
- يُعد جهاز الطرد المركزي هذا من أحدث المعدات التي تتميز بالسلامة أثناء التشغيل. إلا أنه قد يتسبب في تعريض المستخدمين أو غيرهم للخطر إذا تم استخدامه من قبل موظفين غير مدربين، أو بطريقة غير مناسبة، أو لغرض آخر غير الذي تم تصميمه من أجله.
- يجب عدم تحريك جهاز الطرد المركزي أو الطرق عليه أثناء التشغيل.
- في حال حدوث خلل أو أمر طارئ، لا تلمس القاعدة الدوارة قبل أن تتوقف عن الدوران.

- لتجنب التلف الناتج عن التكتيف، يجب أن يقوم جهاز الطرد المركزي بالتسخين لمدة لا تقل عن 3 ساعات في غرفة دافئة قبل توصيله بالتيار الكهربائي، أو التشغيل الساخن لمدة 30 دقيقة في غرفة باردة وذلك عند التغيير من غرفة باردة إلى غرفة دافئة.
- عند حدوث الطرد المركزي مع أقصى عدد من الدورات في الدقيقة، قد لا تتجاوز كثافة المواد أو مخاليط المواد 1.2 كجم/ديسيمتر مكعب.
- يُحظر تشغيل جهاز الطرد المركزي إلا عندما يكون التوازن ضمن الحدود المقبولة.
- يمكن ألا يتم تشغيل جهاز الطرد المركزي في المناطق المهدة بحدوث انفجارات.
- يجب ألا يُستخدم جهاز الطرد المركزي مع المواد القابلة للاشتعال أو المتفجرة أو المواد التي تتفاعل مع بعضها البعض لتنتج الكثير من الطاقة.
- لا تتوفر أنظمة سلامة بيولوجية لجهاز الطرد المركزي هذا.
- يجب عدم تشغيل جهاز الطرد المركزي باستخدام مواد شديدة التآكل والتي يمكن أن تضعف من السلامة الميكانيكية للقواعد الدوارة، وأدوات التعليق، والملحقات.
- يجب أن يتم إجراء الإصلاحات فقط من قبل الموظفين المخولين لتنفيذ ذلك من قبل الجهة المصنعة.
- ولضمان حصول المرضى على أعلى مستوى من السلامة الطبية، تُصنع منتجات IntraSpin من مواد تتوافق حيويًا مع البلازما البشرية.
- لا يُسمح ببيع هذا المنتج في كل سوقٍ وقد لا يكون متاحًا في السوق. يُرجى التشاور مع ممثل المحلي للحصول على مزيد من المعلومات.

4 مكونات نظام INTRASPIN

مكون	الكمية لكل نظام
الطرد المركزي IntraSpin بما في ذلك:	1
سلك الطاقة	1
فتيل	2
وجع عرافة	1
أنابيب جمع عينات الدم وأنابيب التوازن من Greiner (للاستخدام مرة واحدة فقط).	150
مجموعة جمع الدم للسلامة من غرينر + حامل ، 21 غ (للاستخدام مرة واحدة)	24
عاصبة اللاتكس الحرة	1
حامل أنابيب الاختبار	1
مقص جراحي منحنى	1
ملقط الأنسجة الجراحية	1
وعاء دائري من الستانلس ستيل	1
وعاء مستطيل من الاستانلس ستيل	1
ملعقة ثنائية حامل المواد الحيوية	1
باكر المواد الحيوية المزدوجة	1
علبة Xpression®	1

يوصى ويبرر فقط المكونات المتوافقة التي تم التحقق منها للاستخدام المباشر مع جهاز الطرد المركزي IntraSpin

# الجزء المتوافق	وصف
455092	أنبوب منشط متصل 9 مل CAT، غطاء أحمر
455001	غطاء أبيض 9 مل Z أنبوب لا يوجد المضاف
BHEXZ (E613)	مفتاح IntraSpin سداسي ، 110 فولت و 220 فولت
BROTORZ (E3694)	دوار IntraSpin ، 100 فولت و 220 فولت

BPOWER110Z (E1673)	سلك الطاقة IntraSpin ، 110 فولت
BPOWER220Z (E1669)	سلك الطاقة IntraSpin ، 220 فولت
BTUBEHOLDZ (E872 x 1)	استبدال حامل أنبوب IntraSpin
BFUSE110Z (E997)	IntraSpin فيوز 110v
BFUSE220Z (E891)	IntraSpin فيوز 220v

5 إعداد أجهزة الطرد المركزي الموجزة

- قم بإزالة وحفظ مسامير النقل من أسفل جهاز الطرد المركزي.
- قم بتوصيل كبل التيار المتردد وقم بتوصيله بمأخذ التيار الكهربائي.
- تشغيل جهاز الطرد المركزي باستخدام مفتاح الروك على الجزء الخلفي من الجهاز.
- حدد السرعة والوقت: السرعة = 2700 & الوقت = 12:00 دقيقة.
- اضغط على START (البدء).
- سيفتح غطاء جهاز الطرد المركزي تلقائياً في نهاية كل دورة.
- بعد أول عملية، يُسجل الوقت والسرعة في ذاكرة جهاز الطرد المركزي ما لم يتم تغيير الإعدادات.

6 التنبهات والتعليمات المتعلقة باستخدام أنابيب جمع عينات الدم ومجموعة جمع عينات الدم

- لا تستخدم الأنابيب في حالة وجود أجسام غريبة فيها.
- يجب ملء أنابيب جمع عينات الدم بالكامل.
- تعامل مع جميع العينات البيولوجية وأدوات جمع عينات الدم "الحادة" (مثل الإبر ومجموعات جمع عينات الدم) وفق السياسات والإجراءات المتبعة في المنشأة التي تعمل فيها.
- لا تتنني الإبرة.
- لا تقم بتحرير آلية أمان الإبرة أو إعادة تفعيلها بالقوة بعد تفعيلها.
- احصل على عناية طبية مناسبة في حالة التعرض لعينات بيولوجية (على سبيل المثال من خلال إصابة ثقب) بسبب احتمال انتقال فيروس نقص المناعة البشرية (الإيدز) أو التهاب الكبد الفيروسي أو الأمراض المعدية الأخرى.
- تخلص من جميع الأدوات الحادة لجمع الدم في حاويات الخطر البيولوجي المعتمدة.
- لا يُنصح بنقل عينة من حقنة إلى أنبوب.
- إذا تم جمع الدم عن طريق الوريد (IV) ، فاتبع سياسات وإجراءات مؤسستك للتأكد من أن الخط قد تم تطهيره من محلول IV قبل البدء في ملء أنابيب جمع الدم.
- قد يظهر مُسرّع تخثر الدم باللون الأبيض على سطح الأنبوب ، وهو ما لا يؤثر على أداء الأنابيب. في حالة وجود أي تلون أو رواسب أخرى في الأنبوب ، لا ينبغي استخدامه.
- لا تستخدم الأنابيب بعد تاريخ انتهاء الصلاحية.
- قم بتخزين أنابيب جمع عينات الدم في درجة حرارة تتراوح بين 4 و 25 درجة مئوية (40-77 درجة فهرنهايت).
- قم بتخزين مجموعة جمع عينات الدم (الإبرة والحامل) في درجة حرارة تتراوح بين 4 و 36 درجة مئوية (40-97 درجة فهرنهايت).
- تجنب التعرض لأشعة الشمس المباشرة. قد يؤدي تجاوز الحد الأقصى لدرجة حرارة التخزين الموصى بها إلى ضعف جودة الأنبوب (أي فقدان الفراغ أو التلويين وما إلى ذلك).
- لمنع التدفق العكسي ، ضع ذراع المريض في وضع لأسفل ، أمسك الأنبوب مع الغطاء لأعلى ، قم بتحرير العاصبة بمجرد أن يبدأ الدم في التدفق في الأنبوب ، وتجنب ملامسة محتويات الأنبوب للغطاء أو نهاية الإبرة أثناء بزل الوريد.
- تأكد من أن المواد التالية يمكن الوصول إليها بسهولة قبل إجراء بزل الوريد: جميع أنابيب جمع الدم اللازمة ، والملصقات المحددة لتحديد العينات الإيجابية للمريض ، وإبر جمع الدم وحاملها ، ومسحة الكحول لتنظيف موقع البزل ، والشاش النظيف ، وعاصبة الجص ، والجص اللاصق أو ضمادة ، حاوية الخطر البيولوجي المعتمدة. للحماية من التعرض لمسببات الأمراض المنقولة بالدم ، يوصى باستخدام معدات الوقاية الشخصية المناسبة (مثل القفازات ، ومعطف المختبر ، والنظارات الواقية ، وما إلى ذلك).

تقنية بزل الوريد وجمع عينات الدم:

يجب أن يتم جمع الدم في أسرع وقت ممكن ، حيث لا يوجد مضادات تخثر في أنابيب التجميع. ستبدأ عينة الدم في التخثر على الفور. ارتد قفازات أثناء بزل الوريد وعند التعامل مع أنابيب جمع الدم لتقليل خطر التعرض. قبل سحب الدم ، امسح الجزء العلوي من غطاء (أغطية) أنبوب الدم بمناديل مطهرة من اختيارك. قم بإزالة الغطاء فوق قسم الصمام في الإبرة. تحضير موقع بزل الوريد بمطهر مناسب. لا تحسس منطقة بزل الوريد بعد التطهير. ضع ذراع المريض في وضع النزول. إزالة درع الإبرة. إجراء بزل الوريد مع ذراع لأسفل وغطاء الأنبوب العلوي. تثبت الإبرة بشريط لاصق عند الضرورة. ادفع أنبوب جمع الدم في الحامل وعلى صمام الإبرة الذي يتقب الحجاب الحاجز المطاطي لأنبوب جمع الدم. قم بتوسيط أنابيب جمع الدم في الحامل عند اختراق الغطاء لمنع اختراق الجدار الجانبي وفقدان الفراغ المبكر المبكر. قم بإزالة العاصبة بمجرد ظهور الدم في أنبوب جمع الدم. أثناء الإجراء ، احرص دائمًا على تثبيت أنبوب التجميع في مكانه بالضغط عليه بإبهام. هذا سيضمن سحب فراغ كامل. سيتم ملء أنبوب جمع الدم تلقائيًا. إذا لم يتدفق الدم إلى أنبوب التجميع أو إذا توقف تدفق الدم قبل جمع عينة مناسبة ، يُفترض الخطوات التالية لإكمال مجموعة مرضية:

- ادفع أنبوب جمع الدم للأمام لضمان اختراق الغطاء.
 - قم بتأكيد الموضع الصحيح للإبرة في الوريد.
 - إذا استمر تدفق الدم ، قم بإزالة أنبوب التجميع والتخلص منه بشكل مناسب. احصل على أنبوب تجميع جديد وادفعه إلى الحامل.
 - إذا لم يتم سحب أنبوب التجميع الثاني ، فقم بإزالة الإبرة وأنبوب التجميع والتخلص منهما بشكل مناسب. كرر الإجراء.
 - عندما يتم الوصول إلى الحد الأقصى لحجم ملء أنبوب جمع الدم ، أخرجه برفق من الحامل. كرر مع أنبوب جمع الدم الثاني.
- اقلب كل أنبوب تجميع برفق فور إزالته من الحامل. لا تهز الأنابيب المملوءة بعينة الدم. قد يسبب الخلط القوي الرغوة أو انحلال الدم. قد يؤدي الخلط غير الكافي أو الخلط المتأخر في أنابيب المصل إلى تأخر التخثر.

عند الانتهاء من جمع عينات الدم، قم بإخراج الإبرة من الوريد. قم بتفعيل آلية الأمان (حاجز الأمان) للإبرة عن طريق الضغط على جانبي المحور لتعشيق القفل. حرك آلية الأمان إلى الخلف حتى تسمع صوت نقرة. لا تقم بإعادة تغطية الإبرة لأن هذا يزيد من خطر إصابات الوخز بالإبرة والتعرض للدم. تخلص من الإبرة المستخدمة والحامل في حاوية مناسبة للتخلص من المواد البيولوجية الخطرة. إذا رغبت في ذلك ، ضع ضمادة بمجرد حدوث التخثر. يوصى بإبقاء أنابيب التجميع المملوءة في وضع عمودي. وبمجرد امتلاء الأنبوب الثاني، قم بإزالته وضع الأنبوبين الأول والثاني في جهاز الطرد المركزي في مواقع متقابلة لموازنة الدوار. أغلق غطاء جهاز الطرد المركزي Intraspin واضغط على الزر START (البداية) للسماح بتدوير الأنبوبين لمدة 12 دقيقة.

في حالة الحاجة إلى أكثر من أنبوبين من الدم، يرجى اتباع هذا الإجراء البديل: بعد جمع أول أنبوبين من الدم وقلبهما برفق، قم بوضعهما على الفور في جهاز الطرد المركزي IntraSpin مقابلين لبعضهما لضمان توازن جهاز الطرد المركزي على بشكل صحيح. أغلق الغطاء واضغط على زر START واسمح لجهاز الطرد المركزي بالتشغيل أثناء جمع أنابيب الدم المتبقية. اضغط على زر STOP واسمح لأجهزة الطرد المركزي بالتوقف تمامًا. سيتم فتح الغطاء ؛ ضع الأنابيب المتبقية على الفور في جهاز الطرد المركزي المقابل لبعضها البعض لضمان التوازن الصحيح واضغط على زر START لإعادة ضبط واستكمال البروتوكول الموصى به.

ضع دائمًا الأنابيب بشكل زوجي وضعها في مواضع متقابلة لموازنة القاعدة الدوارة لجهاز الطرد المركزي. تجنب موازنة الأنابيب دائمًا في الدوار قبل الضغط على زر START (البداية) أو قد يتسبب ذلك في إلحاق أضرار جسيمة بجهاز الطرد المركزي أو التخثر غير السليم و/ أو انفصال الدم. إذا لم تكن الأنابيب متوازنة بشكل صحيح ، فسوف يكون هناك الكثير من الاهتزازات أثناء الطرد المركزي وستؤدي إلى تجلط فبريني L-PRF ضعيف.

إذا كان لديك عدد فردي من أنابيب جمع عينات الدم في جهاز الطرد المركزي، فضع أنبوبًا ذا غطاء أبيض لتحقيق التوازن (على سبيل المثال، أنبوب 455001) مملوءًا بالماء إلى الخط المشار إليه، مقابل الأنبوب غير المقترن في القاعدة الدوارة. سيسمح هذا بتحقيق التوازن لجهاز الطرد المركزي بشكل صحيح.

ابدأ عملية التثقيب مباشرة بعد جمع عينات الدم. تؤثر التأخيرات على إجراء فصل الدم وتؤدي إلى ضعف جلطة الفبرين L-PRF.

7 تحضير L-PRF

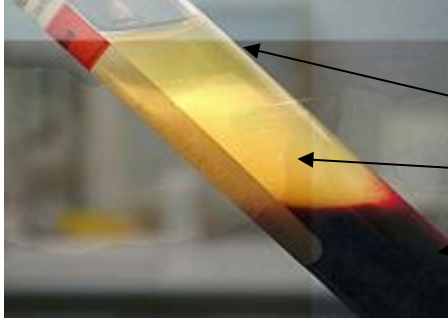

بعد انتهاء عملية التنفيل، ستظهر ثلاث شرائح بوضوح:

1. الشريحة العلوية = الصفائح الدموية الفقيرة بالبلازما (PPP)
2. الشريحة الوسطى = الفيبرين المتخثر: L-PRF
3. الشريحة السفلى = خلايا الدم الحمراء المتخثرة.

يجب تحضير أغشية أو سدادات الفيبرين L-PRF بشكل سريع نسبياً: تبلغ 0-15 دقيقة بعد التنفيل أو تقلص حجم التخثر من خلال إطلاق مصبل الدم المحبوس. بعد الطرد المركزي، قم بإزالة السدادة المطاطية من كل أنبوب. باستخدام ملقط الأنسجة الجراحية إزالة الجلطة L-PRF من الأنبوب. قم بكشط جلطة خلايا الدم الحمراء برفق من جلطة الفيبرين L-PRF® أسفل الاتحاد مباشرةً، باستخدام ملقط حامل المواد الحيوية المزدوجة، بحيث يتم إرفاق كمية صغيرة وبقية فقط من خلايا الدم الحمراء بجلطة L-PRF. ضع جلطة الفيبرين على صينية Xpression المثقبة.

8 إعداد فبرين ماتريكس

البروتوكول رقم 1 / غشاء L-PRF

ضع كل من جلاتات الفيبرين على صينية Xpression المثقبة. بمجرد وضع كل جلاتات الفيبرين، ضع لوحة ضغط Xpression وغطاء Xpression المرجح على جلاتات الفيبرين دون ممارسة أي ضغط على الجلاتات.

اسمح لوزن الغطاء بالضغط ببطء على جلطة الفيبرين أثناء ترشيح الإفرازات في أسفل القالب. لا تضغط على الغطاء المرجح. تقوم قوة الجاذبية على الغطاء المحملة بضغط التخثر بلطفٍ وتسريع سريان مصبل الدم من تخثر L-PRF دون إتلاف شبكة الفيبرين.

انتظر ما لا يقل عن 5 دقائق قبل إزالة واستخدام أي أغشية من فيبرين. لا تقم بإزالة أي من مصفوفات الفيبرين قبل الوقت الفعلي لاستخدامها. قد يبقى غشاء الفيبرين في علبة Xpression لمدة تصل إلى 3 ساعات



البروتوكول رقم 2 / قابس L-PRF

ضع جلطة الفيبرين داخل أسطوانة تصنيع القابس الأبيض. استخدم المكبس للضغط ببطء على الجلطة داخل أسطوانة تصنيع قابس L-PRF الأبيض. باستخدام هذه التقنية ، سيتمكن المرء من تكوين قابس فبريني سميك ومستدير لمقبس الاستخراج. بالنسبة للسن واحد ، قد يكون قابس L-PRF واحداً كافياً. قد تحتاج الأضراس التمهيدية إلى سداة L-PRF ، وقد تكون هناك حاجة إلى ثلاث سدادات L-PRF للأضراس ، اعتماداً على حجم مقبس الاستخراج وحجم جلطة الفيبرين التي تم إنشاؤها.

توفر خصائص استخدام L-PRF حجماً متوسطاً لاستخدامه مخلوطاً مع المادة الحيوية التي تفضلها. باستخدام أيّ من بروتوكولات المزج التالية، يتم الحصول على المادة الحيوية مُدمجة في مصفوفة الفيبرين مما يزيد من قدرتها العلاجية والبيولوجية.

البروتوكول رقم 3 - مزيج L-PRF / المواد الحيوية

لإنشاء مزيج "يشبه المعجون" يُمكن تشكيله بلطف باستخدام مكونات المواد الحيوية بالشكل والسُمك المرغوب فيهما، استخدم البروتوكول التالي: اقطع غشاء الليفين L-PRF بلطف إلى قطع صغيرة في طبق معقم مع مقص منحنى الجراحية. أضف الكمية المطلوبة من مادة الطعم العظمي. أمزج L-PRF بلطف مع مادة الطعم العظمي. يمكن وضع هذا الخليط في عيوب باستخدام ملوق حامل المواد الحيوية المزوجة.



البروتوكول رقم 4 - مزيج مصفوفة L-PRF / المواد الحيوية

ضع كمية محددة سلفاً من مادة الطعم العظمي في وعاءٍ أو في قالبٍ مُعقم. اغمس غشاء L-PRF أو قطع غشاء L-PRF في مادة الطعم العظمي حتى يُغطى السطح تماماً بمادة الطعم العظمي. بدلاً من ذلك، يُمكن رش مادة الطعم العظمي على غشاء L-PRF حتى يُغطى السطح تماماً. ملاحظة: قد يحتفظ غشاء L-PRF الأكثر رطوبة بمادة الطعم العظمي لمدة أكثر قليلاً من غشاء L-PRF الأكثر جفافاً. يجب أن تغمر مادة الطعم العظمي سطح L-PRF ولكن إذا رغبت، يُمكنك الضغط بلطفٍ على مادة الطعم العظمي داخل غشاء L-PRF. يمكن استخدام ملقط الأنسجة الجراحي لوضع هذا الخليط في العيب العظمي.

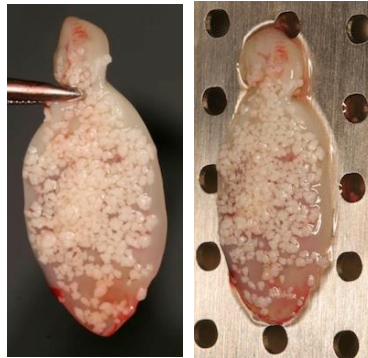

البروتوكول رقم 5 - ترطيب المواد الحيوية

أضف الكمية المطلوبة من مادة ترقيق العظام إلى وعاء أو صينية معقمة. استخدم الإفرازات من أسفل علبة Xpression لتجميع مادة الكسب غير المشروع. امزج بدقة مادة الإفرازات والمواد المطعمة للعظام. يمكن وضع هذا الخليط في العيوب العظمية باستخدام ملعقة حامل المواد الحيوية المزدوجة.



9 تنظيف وتطهير مجموعة الأنسجة

يتيح علبة Xpression من تجميع أغشية الفيبرين بسماكة ثابتة بسهولة. يمكن جمع الإفرازات من علبة Xpression ، أسفل صينية Xpression المثقبة. يتضمن علبة Xpression أسطوانة لتصنيع سداة L-PRF ومكبس لتصنيع سدادات L-PRF التي تناسب بسهولة مأخذ ما بعد الاستخراج.



الموزون Xpression غطاء

Xpression لوحة ضغط

صينية Xpression المثقبة في صينية
تجميع Xpression

علبة Xpression والأدوات المساعدة لا يتم توفيرها معقمة. قم بإزالة والتخلص من أي مواد شحن قبل التعقيم الأولي. قم بتنظيف وتعقيم علبة Xpression والأدوات المساعدة قبل كل استخدام.

قم بتفكيك علبة Xpression قبل كل دورة تنظيف وتعقيم لتجنب تغليف الحطام وتغيير لون المواد و / أو التجفيف غير الكافي للمكونات. لا يُراد إزالة أسطوانة تصنيع قابس L-PRF وحاوية المكبس من صينية Xpression المثقبة للتنظيف والتعقيم.

تنظيف: (1) إزالة أي حطام مرئي من مكونات علبة Xpression والأدوات المساعدة باستخدام فرشاة ناعمة وناعمة أو عامل تطهير واسع النطاق مثل إنزيماكس Hu-Friedy's أو ما يعادله. شطف جيدا. (2) ضع مكونات علبة Xpression والأدوات المساعدة في حاوية ذات حجم مناسب من نفس المحلول والصوت لمدة 10 دقائق. شطف جيدا. (3) اغسل مكونات علبة Xpression والأدوات المساعدة بحول الأيزوبروبيل لإزالة أي بقايا صابون ومعادن. (4) امسح مكونات علبة Xpression

والأدوات المساعدة بمنشفة خالية من النسالة وجففها تمامًا. راجع ملصق عامل التنظيف المستخدم للحصول على تعليمات الاستخدام.

تعقيم: (1) ضع علبة Xpression المعاد تجميعه والأدوات المساعدة في كيس تعقيم أو لفافة تعقيم خالية من FDA. (2) قم بإجراء إحدى دورات التعقيم المؤهلة التالية:

وقت التعرض	وقت التجفيف الأدنى	درجة الحرارة	طريقة التعقيم
4 دقيقة	20-30 دقيقة	132°C (270°F)	قبل تفريغ البخار (ANSI/AAMI ST79)
3 دقيقة	20-30 دقيقة	134°C (273°F)	قبل تفريغ البخار (UK DoH Health Technical Memorandum 01-01)

انتباه! قد يؤدي التنظيف غير السليم إلى التعقيم غير الكافي. قد يؤدي الفشل في تجفيف مكونات علبة Xpression والأدوات المساعدة بالكامل أثناء التعقيم إلى ترك الرطوبة ويتسبب في تغير اللون والأكسدة. سيؤدي استخدام بيروكسيد الهيدروجين أو عوامل مؤكسدة أخرى إلى إتلاف سطح مكونات علبة Xpression والأدوات المساعدة. يوصى بإجراء اختبار دوري وتنظيف ومعايرة لمعدات الأوتوكلاف لضمان بقاء الوحدة في حالة عمل مناسبة.

10 تنظيف وصيانة أجهزة الطرد المركزي

يمكن أن يُصاب هذا الجهاز بالتلوث. اسحب قابس التيار الكهربائي قبل التنظيف. يجب عدم تنظيف أجهزة الطرد المركزي والقواعد الدوارة والملحقات في آلات الشطف. يمكن أن يتم تنظيفها باليد وتطهيرها بالسوائل فقط. يجب أن تتراوح درجة حرارة الماء بين 20 - 25 درجة مئوية. يمكن فقط استخدام المنظفات / المطهرات التي لها درجة حموضة بين 5 - 8 والتي لا تحتوي على قلويات كاوية وبيروكسيدات ومركبات الكلور والأحماض ومحاليل قلوية. من أجل منع حدوث التآكل الذي تسببه مواد التنظيف أو المطهرات، يجب مراعاة التامة لدليل التطبيق الصادر من الجهة المصنعة لمادة التنظيف أو المطهر.

قم بتنظيف تبييت الطرد المركزي وغرفة الطرد المركزي بانتظام باستخدام الصابون أو المنظفات اللطيفة وقطعة قماش مبللة إذا لزم الأمر لمنع التآكل من خلال التصاق الشوائب. مكونات مواد التنظيف المناسبة تتضمن الصابون ، الفاعل بالسطح الأيوني و الفاعل بالسطح غير الأيوني. بعد استخدام مواد التنظيف، أزل رواسب مواد التنظيف عن طريق المسح بقطعة قماش مبللة. يجب تجفيف الأسطح مباشرة بعد التنظيف. في حالة تكوين ماء التكاثف، قم بتجفيف غرفة الطرد المركزي عن طريق المسح بقطعة قماش ماصة. افرك بخفة الغطاء المطاطي الخاص بغرفة الطرد المركزي باستخدام بودرة التلك أو منتج العناية بالمطاط بعد كل عملية تنظيف. يتم فحص غرفة الطرد المركزي بحثًا عن وجود أي تلف. إذا تم العثور على ضرر ذي صلة بالسلامة، فقد لا يتم تشغيل جهاز الطرد المركزي. وفي هذه الحالة، قم بإخطار خدمة العملاء.

لتطهير السطح ، إذا اخترقت المواد الملوثة غرفة الطرد المركزي، فيجب تطهيرها على الفور. مكونات المواد المطهرة المناسبة تتضمن الإيثانول والبروبانول العادي وإيثيل هكسانول و الفاعل بالسطح الأيوني ومثبطات التآكل. بعد استخدام المطهرات، قم بإزالة بقايا المطهر عن طريق المسح بقطعة قماش مبللة. يجب تجفيف الأسطح مباشرة بعد التطهير.

لإزالة الملوثات المشعة ، يجب أن تحمل المادة ملصقًا خاصًا يُشير إلى أنها مادة تستخدم لإزالة الملوثات المشعة. مكونات المواد المناسبة لإزالة الملوثات المشعة الفاعل بالسطح الأيوني ، الفاعل بالسطح غير الأيوني ، الإيثانول المائي. بعد إزالة الملوثات المشعة، أزل بقايا المادة عن طريق المسح بقطعة قماش مبللة. يجب تجفيف الأسطح مباشرة بعد إزالة الملوثات المشعة.

11 القاعدة الدوارة والملحقات التنظيف والصيانة

لتجنب تآكل المواد والتغيرات التي تطرأ عليها، يجب تنظيف القاعدة الدوارة وملحقاتها بانتظام بالصابون أو باستخدام مادة منظفة خفيفة وقطعة قماش مبللة. ويوصى بإجراء عملية التنظيف مرة واحدة كل أسبوع على الأقل. حيث إنه يجب إزالة الملوثات على الفور.

مكونات مواد التنظيف المناسبة تتضمن الصابون ، الفاعل بالسطح الأيوني و الفاعل بالسطح غير الأيوني. بعد استخدام مواد التنظيف، أزل رواسب مواد التنظيف عن طريق الشطف بالماء (الجزء الخارجي للجهاز فقط) أو امسحها بقطعة قماش مبللة. يجب تجفيف القاعدة الدوارة وملحقاتها فور تنظيفها. تحقق من القاعدة الدوارة وملحقاتها أسبوعياً بحثاً عن تلف الصدأ والتآكل. يجب عدم استخدام القاعدة الدوارة وملحقاتها في حال ظهور علامات التآكل أو الصدأ عليها. تأكد من إحكام تثبيت القاعدة الدوارة أسبوعياً. إذا كان يجب وضع مادة مُعدية داخل القاعدة الدوارة وملحقاتها، فيجب تطهير كل منها بصورة مناسبة.

مكونات المواد المطهرة المناسبة تتضمن الإيثانول والبروبانول العادي وإيثيل هكسانول و الفاعل بالسطح الأيوني ومثبطات التآكل. بعد استخدام المواد المطهرة، أزل بقايا المواد المطهرة عن طريق الشطف بالماء (الجزء الخارجي للجهاز فقط) أو امسحها بقطعة قماش مبللة. يجب تجفيف القاعدة الدوارة وملحقاتها مباشرة بعد التطهير.

لإزالة الملوثات المشعة ، يجب أن تحمل المادة ملصقاً خاصاً يُشير إلى أنها مادة تستخدم لإزالة الملوثات المشعة. مكونات المواد المناسبة لإزالة الملوثات المشعة تتضمن الفاعل بالسطح الأيوني ، الفاعل بالسطح غير الأيوني والإيثانول المائي. بعد إزالة الملوثات المشعة، أزل بقايا المادة عن طريق الشطف بالماء (الجزء الخارجي للجهاز فقط) أو امسحها بقطعة قماش مبللة. يجب تجفيف القاعدة الدوارة وملحقاتها مباشرة بعد إزالة الملوثات المشعة.

يمكن تعقيم القاعدة الدوارة عند 121 درجة مئوية / 250 درجة فهرنهايت لمدة 20 دقيقة وتجفيفه بشكل مناسب. لأسباب تتعلق بالسلامة، يجب تبديل القاعدة الدوارة بعد إجراء 10 دورات تعقيم. يعمل التعقيم بالبخار على تسريع عملية الشبخوخة للبلاستيك وقد يتسبب في تغير اللون. بعد التعقيم ، انتظر حتى يبرد الدوار إلى درجة الحرارة المحيطة قبل استخدامه مرة أخرى. لا يتوفر مؤشر يسمح بمعرفة درجة التعقيم.

تقتصر فترة استخدام القاعدة الدوارة على 50000 دورة تشغيل (عمليات تشغيل الطرد المركزي) أو 5 سنوات ، أيهما أسبق. يمكن رؤية الحد الأقصى المسموح به من دورات التشغيل على القاعدة الدوارة. لأسباب تتعلق بالسلامة، قد لا يتم استخدام القاعدة الدوارة عند الوصول إلى الحد الأقصى المسموح به من دورات التشغيل (المحددة عليها). تم تجهيز الجهاز بعدد دورات، والذي يحسب دورات التشغيل (عمليات تشغيل الطرد المركزي).

في حالة كسر أنبوب الدم ، يجب إزالة جميع الأجزاء المكسورة والدم بالكامل. يجب تنظيف جهاز الطرد المركزي تمامًا كما هو موضح وسيتم استبدال المدخلات المطاطية وكذلك الأكمال البلاستيكية للدوار.

12 المواصفات الفنية للطرد المركزي

نوع الطراز	IS220Z	IS110Z
جهد التيار الكهربائي(± 10%)	1 فولت 200 - 240	1 فولت 100 - 127
تردد التيار الكهربائي	50 - 60 هرتز	50 - 60 هرتز
الحمل الموصل	100 فولت أمبير	100 فولت أمبير
استهلاك التيار	0.5 أمبير	1.0 أمبير
سعة	8 x 10 مليلتر	
أقصى كثافة مسموح بها	1.2 كجم/ ديسيمتر مكعب	

السرعة القصوى (دورة في الدقيقة)	6,000
القوة (قوة الطرد المركزي النسبية)	3,461
الطاقة الحركية	750 نانومتر
موقع الإعداد	داخل المباني فقط
الارتفاع عن سطح البحر	ما يصل إلى 2000 متر فوق سطح البحر
درجة الحرارة المحيطة للتشغيل	2 درجة مئوية إلى 40 درجة مئوية
الرطوبة النسبية للتشغيل	أقصى نسبة للرطوبة النسبية 80 % لدرجات الحرارة التي تصل إلى 31 درجة مئوية، مع انخفاض خطي إلى 50 % من الرطوبة النسبية عند 40 درجة مئوية.
فئة الجهد الزائد	II
درجة التلوث	2
فئة حماية الجهاز	I
	غير مناسب للاستخدام في المناطق المعرضة للانفجار.
التداخل المنبعث، مناعة ضد التداخل	هيئة الاتصالات الفيدرالية الفئة ب الفئة ب، EN / IEC 61326-1
مستوى الضوضاء (حسب القاعدة الدوارة)	50 ≤ ديسيبل (A)
عرض الطرد المركزي	261 ملم
عمق الطرد المركزي	353 ملم
ارتفاع الطرد المركزي	228 ملم
وزن جهاز الطرد المركزي	حوالي 9 كجم

13 تعليمات تشغيل أجهزة الطرد المركزي

من الضروري إزالة جهاز تأمين النقل المكون من 2 من البراغي (a) والفاصلين (b). حافظ على جهاز تأمين النقل في مكان آمن، حيث يجب تركيبه مرة أخرى قبل نقل الجهاز. يمكن نقل الجهاز باستخدام جهاز تأمين النقل المركب فقط. لحماية الجهاز من التلف أثناء النقل، يتم تركيب المحرك في مكانه. يجب إزالة جهاز تأمين النقل هذا عند تشغيل الجهاز.

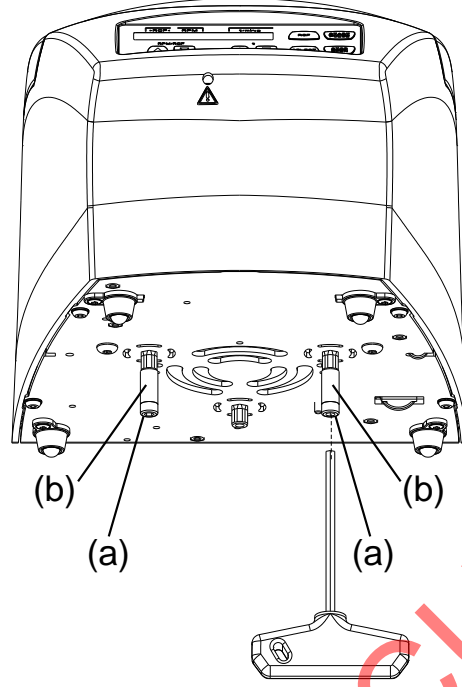

13.1 التشغيل الأولي

- قم بإزالة جهاز تأمين النقل من الجانب السفلي لجهاز الطرد المركزي.
- ضع جهاز الطرد المركزي بطريقة مستقرة ومستوية في مكان مناسب. عند تشغيل جهاز الطرد المركزي، يحظر تواجد أي أشخاص أو مواد خطيرة، أو عناصر في حدود هامش السلامة البالغ 300 ملم حول جهاز الطرد المركزي.
- يُحظر غلق فتحات التهوية. يجب الحفاظ على مسافة 300 ملم بين فتحات التهوية وفتحات جهاز الطرد المركزي.
- تحقق مما إذا كان جهد التيار الكهربائي مطابقاً للبيان الموجود على لوحة النوع.
- قم بتوصيل جهاز الطرد المركزي الذي لديه سلك طاقة بمقيس التيار الكهربائي القياسي.
- قم بتشغيل مفتاح التيار الكهربائي.
- تظهر الشاشات التالية على اللوحة: نوع طراز جهاز الطرد المركزي، وإصدار البرنامج، وآخر بيانات الطرد المركزي المستخدمة.
- إذا تم غلق الغطاء، فسيتم عرض رسالة "Open the lid" (افتح الغطاء). في هذه الحالة، افتح الغطاء لعرض بيانات الطرد المركزي.

13.2 فتح وإغلاق غطاء الطرد المركزي

- لا يُمكن فتح الغطاء إلا إذا تم تشغيل الطرد المركزي وكانت القاعدة الدوارة ثابتة. عند تنشيط عداد الدورات، بعد تشغيل الطرد المركزي، وكان الغطاء مفتوحاً، سيتم عرض العدد المتبقي من دورات التشغيل (تشغيل الطرد المركزي) لفترة وجيزة.



مثال

STOP
OPEN

لفتح الغطاء ، اضغط على المفتاح التالي . يُفتح الغطاء بواسطة المحرك .  يشير إلى فتح الغطاء .

>RCF<	RPM	t/min:s
6	4500	5:00

مثال :

تجنب وضع أصابعك بين الغطاء والمبيت . يجب عدم دفع الغطاء المغلق بقوة . لإغلاق الغطاء ، اضغط برفق على الحافة الأمامية للغطاء .  يشير غطاء مغلق .

>RCF<	RPM	t/min:s
6	4500	5:00

مثال :

13.3 الفتح الطارئ

في حالة انقطاع التيار الكهربائي، لا يمكن فتح الغطاء باستخدام المحرك . يجب أن تتم عملية الفتح الطارئة باليد . ولإجراء عملية الفتح في حالة الطوارئ، أغلق مفتاح التيار الكهربائي (إعداد التبديل "0") . انظر من خلال النافذة في الغطاء للتأكد من أن القاعدة الدوارة في حالة توقف تام . افتح الغطاء عندما تكون القاعدة الدوارة في حالة توقف تام فقط . أدخل مفتاح ألن أفقيًا في التجويف (A) وأدره بعناية عكس عقارب الساعة (إلى اليسار) حتى يُفتح الغطاء . احذر! قد يؤدي تدوير مفتاح Allen السداسي في اتجاه عقارب الساعة (إلى اليمين) إلى تلف نظام القفل . اسحب مفتاح ألن خارج التجويف .

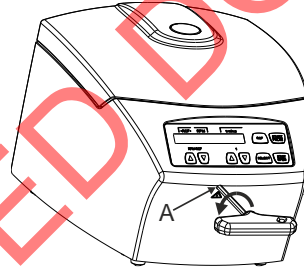

13.4 تركيب القاعدة الدوارة وإزالتها

لإزالة الدوار ، فكّ صامولة تثبيت القاعدة الدوارة من خلال تدويرها عكس اتجاه عقارب الساعة باستخدام مفتاح ألن (مرفق في العبوة) ومن ثمّ انتقل إلى نقطة ضغط الرفع. بعد السيطرة على نقطة ضغط الرفع، يتم تحرير القاعدة الدوارة من مخروط عمود المحرك. أدر صامولة التثبيت حتى ينتهي لك رفع القاعدة الدوارة من عمود المحرك. ارفع القاعدة الدوارة من عمود المحرك.

لتثبيت الدوار ، نظف عمود المحرك (A) وتجويف القاعدة الدوارة ثم ضع طبقة رقيقة من الشحوم على عمود المحرك. حيث تتسبب جزيئات الأوساخ الموجودة بين عمود المحرك والقاعدة الدوارة في منع القاعدة من الثبات بصورة مثالية كما أنها تجعلها تعمل بشكل غير مستقر. ضع القاعدة الدوارة عموديا على عمود المحرك. وعند وضعها، يجب أن تكون دعامة التحديد (B) الموجودة في القاعدة الدوارة متوازية مع كلا السطحين (C) على عمود المحرك. أحكم تثبيت صامولة تثبيت القاعدة الدوارة باستخدام مفتاح ألن (مرفق في العبوة) من خلال التدوير في اتجاه عقارب الساعة. تحقق من القاعدة الدوارة للتأكد من تثبيتها بإحكام.

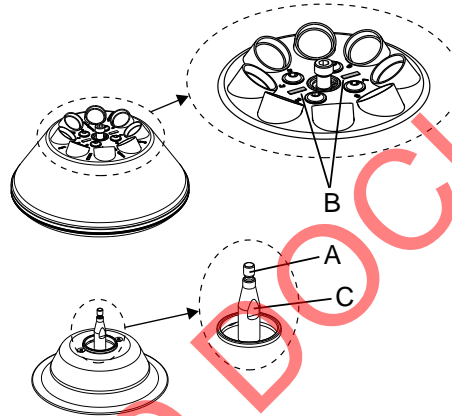

يجب أن تُملأ القواعد الدوارة بصورة متماثلة. يجب توزيع أنابيب الدم بالتساوي على جميع مواقع الدوار.

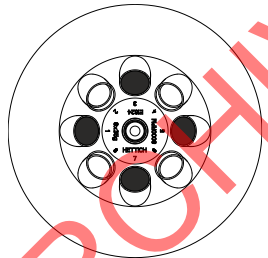

قاعدة دوارة ممتلئة بالتساوي

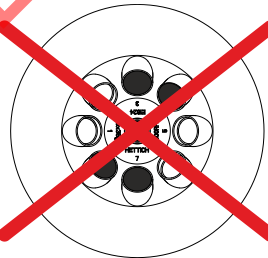

قاعدة دوارة ممتلئة بصورة غير

متساوية

غير مسموح بذلك!

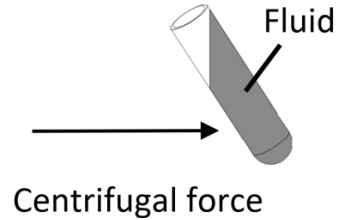

يمكن تعبئة أنابيب الدم فقط خارج جهاز الطرد المركزي. يتم تحديد الكمية القصوى لملء أنابيب الدم على الأنابيب نفسها ويجب ألا تتجاوز الوزن الأقصى المدرج على الدوار. يُمكن ملء حاويات الطرد المركزي بحيث لا يُمكن طرد أي سائل منها أثناء عملية تشغيل الطرد المركزي. عند تعبئة القاعدة الدوارة، قد لا يدخل السائل إلى القاعدة الدوارة أو غرفة الطرد المركزي. من أجل الحفاظ على اختلافات الوزن داخل حاوية أجهزة الطرد المركزي قدر الإمكان هامشيًا ، يوصى بمستوى تعبئة ثابت في أنابيب الدم.

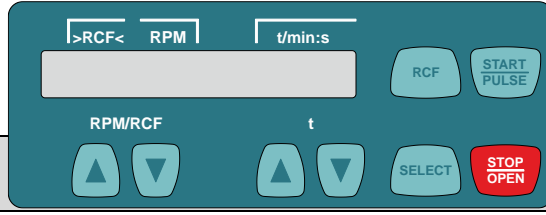

13.5 وصف عناصر العرض



رمز / مفتاح اللوحة	وصف
	الغطاء مفتوح.
	الغطاء مفتوح.
	مساحة عرض الدوران. تُضيء مساحة عرض الدوران، وتدور في اتجاه عكس عقارب الساعة عندما يدور الدوران.
RPM/RCF 	إدخال السرعة مباشرة. إذا تم الضغط على المفتاح باستمرار، فإن القيمة تتغير وتزداد السرعة.
t 	إدخال وقت التشغيل مباشرة. قابل للتعديل بصورة تدرجية تزيد ثانية وتصل إلى دقيقة، وبصورة تدرجية بمعدل دقيقة بدءًا من دقيقة. أدخل معلمات الطرد المركزي. إذا تم الضغط على المفتاح باستمرار، فإن القيمة تتغير وتزداد السرعة.
SELECT	لتفعيل المعلمات الفردية. في كل مرة يتم الضغط على المفتاح، يتم تنشيط المعلمة التالية. اضغط على المفتاح باستمرار لمدة 8 ثوان لاستدعاء "MACHINE MENU" (قائمة الجهاز). في "Machine Menu" حدد قوائم "Info" (المعلومات) و"Settings" (الإعدادات) و"Time & Cycles" (الوقت والدورات). التمرير إلى الأمام في القوائم.
RCF	للتبديل بين عرض السرعة (RPM) وعرض قوة الطرد المركزي النسبي (<RCF>). يتم عرض قيم RCF بين الأسهم < >.
START PULSE	بدء تشغيل الطرد المركزي. إجراء طرد مركزي قصير الأمد. تظل عملية الطرد المركزي قيد التشغيل طالما أن المفتاح مضغوط عليه. لتحديد القوائم "Settings", "Info", و"Time & Cycles".
STOP OPEN	إنهاء تشغيل الطرد المركزي. تنخفض سرعة القاعدة الدوارة حتى التوقف باتباع مرحلة الإيقاف المُحددة مسبقًا. قد يؤدي الضغط على المفتاح مرتين إلى تشغيل خاصية "الإيقاف في حالات الطوارئ". فتح الغطاء.
t/min (الوقت بالدقائق)	وقت التشغيل. قابل للتعديل من 1 إلى 99 دقيقة، بصورة تدرجية تزيد دقيقة في المرة.
t/sec (الوقت بالثواني)	وقت التشغيل. قابل للتعديل من 1 إلى 59 ثانية، بصورة تدرجية بمعدل ثانية في المرة. تشغيل مستمر "--:--". عيّن المعلمات t/min و t/sec على صفر.
RPM	السرعة. يُمكن تعيين القيمة العددية من 200 دورة في الدقيقة إلى السرعة القصوى للقاعدة الدوارة. قابل للتعديل بصورة تدرجية بمعدل 10
>RCF<	قوة الطرد المركزي النسبية. قيمة عددية يُمكن تعيينها وتسبب في سرعة تتراوح بين 200 دورة في الدقيقة وسرعة القاعدة الدوارة القصوى. قابل للتعديل بصورة تدرجية بمعدل 1

	لا يُمكن إدخال قوة الطرد المركزي النسبية (RCF) إلا إذا تم تنشيط مساحة عرض قوة الطرد المركزي النسبية (>RCF<). تعتمد قوة الطرد المركزي النسبية على نصف قطر الطرد المركزي. بعد إدخال قوة الطرد المركزي النسبية، تحقق للتأكد من تعيين نصف قطر الطرد المركزي الصحيح.
RAD/mm	نصف قطر الطرد المركزي قابل للتعديل من 10 ملم إلى 250 ملم، بصورة تدرجية بمعدل 1 ملم. لا يُمكن إدخال نصف قطر الطرد المركزي إلا إذا تم تنشيط مساحة عرض قوة الطرد المركزي (>RCF<)
~_DEC	مرحلة الإيقاف fast (سرعة) = وقت إيقاف قصير, slow (بيطء) = وقت إيقاف طويل.

13.6 إدخال معلمات الطرد المركزي

يُمكن إدخال السرعة (RPM) وقوة الطرد المركزي النسبية (RCF) ونصف قطر الطرد المركزي (RAD) ووقت التشغيل مباشرةً باستخدام المفاتيح  دون الحاجة إلى الضغط المسبق على المفتاح . لا تتم عملية حفظ معلمات الطرد المركزي المُحددة إلا بعد بدء تشغيل الطرد المركزي.

للسرعة (دورة في الدقيقة)

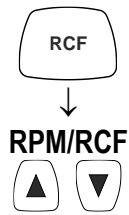

مثال:

اضغط على المفتاح لتنشيط مساحة عرض الدورة في الدقيقة (RPM) حسب الحاجة.

>RCF<	RPM	t/min:s
	4500	5:00

ع ين القيمة المرغوب بها باستخدام المفاتيح

>RCF<	RPM	t/min:s
	4000	5:00

لقوة الطرد المركزي النسبية (RCF) ونصف قطر الطرد المركزي (RAD)

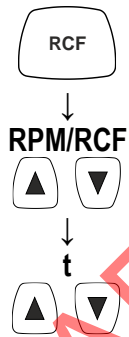

مثال:

اضغط على المفتاح لتنشيط عرض قوة الطرد المركزي النسبية (>RCF<) حسب الحاجة.

>RCF<	RPM	t/min:s
>	1947<	5:00

عَيّن قيمة قوة الطرد المركزي النسبية المرغوب بها باستخدام المفاتيح.

>RCF<	RPM	t/min:s
>	1538<	RAD= 86

عَيّن نصف قطر الطرد المركزي المرغوب به باستخدام المفاتيح حسب الحاجة.

>RCF<	RPM	t/min:s
>	1538<	RAD= 67

>RCF<	RPM	t/min:s
>	1538<	5:00

وقت التشغيل:

دقيقة واحدة، يُمكن تعيين وقت التشغيل بصورة تدرجية بمعدل ثانية في المرة، وعند البدء من دقيقة واحدة، يُمكن تعيينه بصورة تدرجية بمعدل دقيقة. لضبط وضع التشغيل المستمر، يجب تعيين كل من **t/min** (الوقت بالدقائق) و **t/sec** (الوقت بالثواني) على صفر. في مساحة عرض الوقت (t/min:s) يظهر "--:--"



مثال

مثال:



عَيِّن القيمة المرغوب بها باستخدام المفاتيح

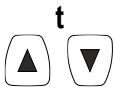

13.7 إدخال معلمات الطرد المركزي باستخدام المفتاح "SELECT" (تحديد)

يُمكن تعيين وقت التشغيل بالدقائق والثواني (معلمات **t/min** (الوقت بالدقائق) و **t/sec** (الوقت بالثواني)). لضبط وضع التشغيل المستمر، يجب تعيين كل من **t/min** و **t/sec** على صفر. في مساحة عرض الوقت (t/min:s) يظهر "--:--"



مثال

يعتمد تسريع الطرد المركزي النسبي (RCF) على نصف قطر الطرد المركزي (RAD). أثناء عملية إدخال قوة الطرد المركزي النسبي، يتم عرض نصف قطر الطرد المركزي المُحدد. في حال عدم الضغط على أي زر لمدة 8 ثوانٍ بعد التحديد أو أثناء إدخال المعلمة، سيتم عرض القيم السابقة على الشاشة. ومن ثمَّ يجب إدخال المعلمة مرة أخرى. بالضغط على الزر **START PULSE** سيتم حفظ الإعدادات. إذا تم إدخال العديد من المعلمات، يجب الضغط على الزر **START PULSE** بعد إعداد آخر معلمة. يمكن إلغاء إدخال المعلمات في أي وقت من خلال الضغط على الزر **STOP OPEN** وفي هذه الحالة، لا يتم حفظ الإعدادات.

مثال:

مساحة عرض عدد الدورات في الدقيقة (RPM)



مثال:

مساحة عرض قوة الطرد المركزي النسبية (>RCF<)



اضغط على المفتاح لتنشيط مساحة عرض عدد الدورات في الدقيقة (RPM) و مساحة عرض قوة الطرد المركزي النسبية (>RCF<) حسب الحاجة.

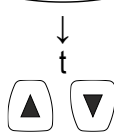
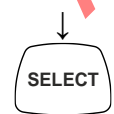

اضغط على المفتاح. t/min: وقت التشغيل، بالدقائق.

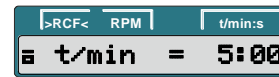
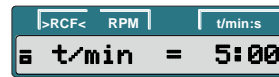

عَيِّن القيمة المرغوب بها باستخدام المفاتيح

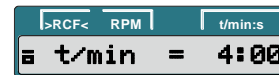
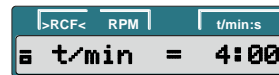

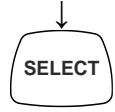

اضغط على المفتاح.
وقت التشغيل، بالثواني. t/sec

>RCF< RPM t/min:s
t/sec = 4:00

>RCF< RPM t/min:s
t/sec = 4:00

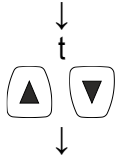

عَيِّن القيمة المرغوب بها باستخدام المفاتيح

>RCF< RPM t/min:s
t/sec = 4:30

>RCF< RPM t/min:s
t/sec = 4:30



اضغط على المفتاح.
السرعة: RPM
RAD/mm : نصف قطر الطرد المركزي.
لا يُمكن عرض نصف قطر الطرد
المركزي وإدخاله إلا إذا تم تنشيط مساحة
عرض قوة الطرد المركزي (>RCF<)

>RCF< RPM t/min:s
RPM = 4500

>RCF< RPM t/min:s
RAD/mm = 86

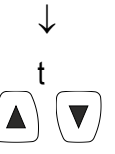

عَيِّن القيمة المرغوب بها باستخدام المفاتيح

>RCF< RPM t/min:s
RPM = 4000

>RCF< RPM t/min:s
RAD/mm = 67



اضغط على المفتاح.
R : نصف قطر الطرد المركزي.
RCF : قوة الطرد المركزي النسبية

>RCF< RPM t/min:s
R: 67 RCF= 1947

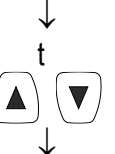

عَيِّن القيمة المرغوب بها باستخدام المفاتيح

>RCF< RPM t/min:s
R: 67 RCF= 1198



اضغط على المفتاح.
_DEC : مرحلة الإيقاف.
fast : (بسرعة) : وقت إيقاف قصير.
slow : (ببطء) : وقت إيقاف طويل

>RCF< RPM t/min:s
_DEC = slow

>RCF< RPM t/min:s
_DEC = slow

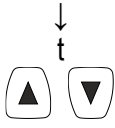

عَيِّن القيمة المرغوب بها باستخدام المفاتيح

>RCF< RPM t/min:s
_DEC = fast

>RCF< RPM t/min:s
_DEC = fast



اضغط على الزر لحفظ الإعدادات

>RCF< RPM t/min:s
4000 4:30

>RCF< RPM t/min:s
> 1198 < 4:30

13.8 عرض لوحة التحكم

بعد تشغيل الطرد المركزي كل مرة، أثناء فتح الغطاء، سيتم عرض العدد المتبقي من دورات التشغيل (تشغيل الطرد المركزي) لفترة وجيزة.

>RCF< RPM t/min:s
RemCycles= 16703

مثال

إذا تم تجاوز فرق الوزن المسموح به داخل حمل القاعدة الدوارة، سيتم إيقاف تشغيل عملية الطرد المركزي أثناء بدء التشغيل و "IMBALANCE" سيظهر.

>RCF< RPM t/min:s
IMBALANCE

مثال

يُمكن إيقاف تشغيل الطرد المركزي في أي وقت من خلال الضغط على المفتاح **STOP OPEN**. يُمكن تحديد معلمات الطرد المركزي وتغييرها أثناء تشغيل الطرد المركزي. وبالرغم من ذلك، فإن القيم التي تم تغييرها يتم تطبيقها فقط على الطرد المركزي الحالي

ولا يتم حفظها. باستخدام المفتاح **RCF** يمكنك التبديل بين مساحة عرض عدد الدورات في الدقيقة (RPM) ومساحة عرض قوة الطرد المركزي النسبية (>RCF<) في أي وقت. وإذا تم تشغيل مساحة عرض قوة الطرد المركزي النسبية (>RCF<) فيجب إدخال نصف قطر الطرد المركزي. لا يمكن إجراء المزيد من عمليات الطرد المركزي إلا بعد فتح الغطاء. سيتم عرض أخطاء التشغيل والأعطال.

>RCF< RPM t/min:s
Open the lid

مثال

13.9 الطرد المركزي مع وقت محدد مسبقاً

مثال:

مساحة عرض عدد الدورات في الدقيقة (RPM)

مثال:

مساحة عرض قوة الطرد المركزي النسبية (>RCF<)

RCF

اضغط على المفتاح لتنشيط مساحة عرض عدد الدورات في الدقيقة (RPM) أو مساحة عرض قوة الطرد المركزي النسبية (>RCF<) حسب الحاجة.

>RCF< RPM t/min:s
4500 5:00

>RCF< RPM t/min:s
> 1947 < 5:00

↓

أدخل معلمات الطرد المركزي المطلوبة

>RCF< RPM t/min:s
4000 4:30

>RCF< RPM t/min:s
> 1538 < 4:30

↓

START PULSE

اضغط على المفتاح لبدء تشغيل الطرد المركزي. أثناء تشغيل جهاز الطرد المركزي، يتم عرض سرعة القاعدة الدوارة أو قيمة قوة الطرد المركزي النسبية الناتجة والوقت المتبقي.

>RCF< RPM t/min:s
4000 3:15

>RCF< RPM t/min:s
> 1538 < 3:15

بعد انقضاء الوقت أو إذا تم إيقاف تشغيل عملية الطرد

المركزي عن طريق الضغط على المفتاح **STOP OPEN** يحدث الإيقاف مع مرحلة الإيقاف المحددة. يتم عرض مرحلة الإيقاف $\sim f$.

>RCF< RPM t/min:s
3980 $\sim f$

>RCF< RPM t/min:s
> 1523 < $\sim f$

13.10 تشغيل مستمر



13.11 إجراء طرد مركزي قصير الأمد



START PULSE

حرر المفتاح مرة أخرى لإنهاء تشغيل الطرد المركزي. يحدث الانتهاء مع مرحلة الإيقاف المحددة. يتم عرض مرحلة الإيقاف f~.

>RCF< RPM t/min:s
3980 f~

>RCF< RPM t/min:s
> 1523< f~

13.12 التوقف الطارئ

مثال:

مساحة عرض عدد الدورات في الدقيقة (RPM)

مثال:

مساحة عرض قوة الطرد المركزي النسبية (>RCF<)

STOP OPEN

اضغط على المفتاح مرتين. أثناء الإيقاف الطارئ، يحدث الانتهاء مع مرحلة الإيقاف "السرعة" (وقت الانتهاء القصير). يتم عرض مرحلة الإيقاف f~.

>RCF< RPM t/min:s
4270 f~

>RCF< RPM t/min:s
> 1753< f~

13.13 عداد الدورات

تم تجهيز جهاز الطرد المركزي بعداد دورات، والذي يحسب دورات التشغيل (تشغيل الطرد المركزي). بعد تشغيل الطرد المركزي كل مرة، أثناء فتح الغطاء، سيتم عرض العدد المتبقي من دورات التشغيل (تشغيل الطرد المركزي) لفترة وجيزة.

>RCF< RPM t/min:s
RemCycles= 16703

مثال

إذا تم تجاوز الحد الأقصى المسموح به لدورات تشغيل القاعدة الدوارة، يتم عرض ما يلي في كل مرة يتم فيها تشغيل الطرد المركزي ويجب إعادة تشغيل الطرد المركزي. يجب استبدال القاعدة الدوارة على الفور بأخرى جديدة لأسباب تتعلق بالسلامة. بعد إجراء عملية تبديل القاعدة الدوارة، يجب إعادة ضبط عداد الدورات ليكون "0"

>RCF< RPM t/min:s
Cycles Passed

مثال

13.14 إعادة تعيين عداد الدورة ليكون صفرًا

بعد تبديل القاعدة الدوارة، يجب إعادة ضبط عداد الدورة ليكون صفرًا مرة أخرى. يحظر إعادة ضبط عداد الدورة ليكون صفرًا إلا إذا تم استبدال القاعدة الدوارة بوحدة جديد أولاً. عندما تكون القاعدة الدوارة في حالة توقف تام، يمكن إعادة ضبط عداد

الدورة على النحو التالي. يمكن إيقاف الإجراء في أي وقت عن طريق الضغط على المفتاح STOP OPEN. وفي هذه الحالة، لا يتم حفظ الإعدادات.

SELECT

اضغط مع الاستمرار على الزر لمدة ثمان ثوانٍ

>RCF< RPM t/min:s
* MACHINE MENU *

SELECT

اضغط على المفتاح حتى يظهر التالي

>RCF< RPM t/min:s
-> Time & Cycles

START PULSE

اضغط على المفتاح.

>RCF< RPM t/min:s
TimeExt= 43 h

مثال:

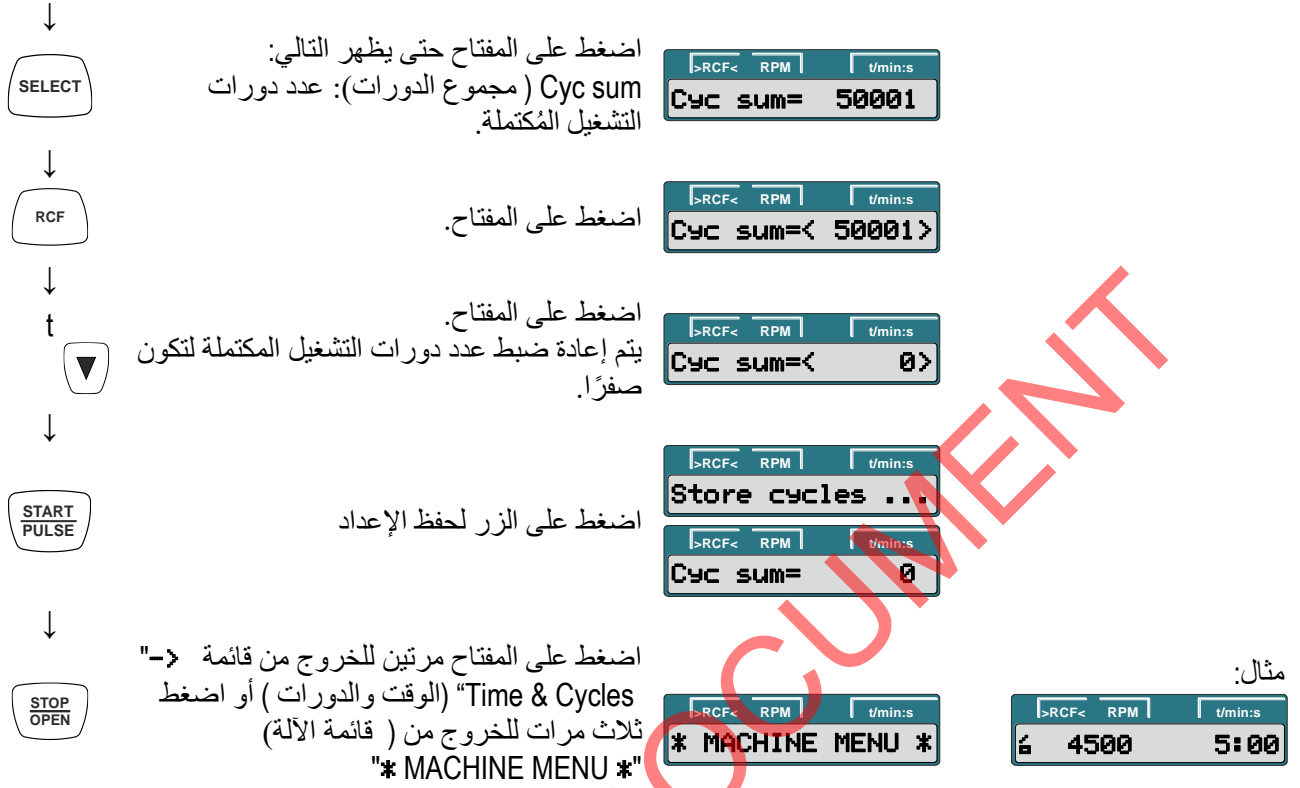

13.15 الإعدادات والاستعلامات



13.16 معلومات نظام الاستعلام

يمكن الاستعلام عن معلومات النظام التالية:

- طراز الجهاز،
- إصدار برنامج الجهاز،
- رقم نوع الجهاز،

- تاريخ تصنيع الجهاز،
- رقم الجهاز التسلسلي،
- نوع مغير التردد
- إصدار برنامج مغير التردد

عندما تكون القاعدة الدوارة في حالة توقف تام، يمكن متابعة الاستعلام على النحو التالي: يمكن إيقاف الإجراء في أي وقت عن طريق الضغط

على المفتاح 

SELECT

اضغط مع الاستمرار على الزر لمدة ثمان ثوانٍ

>RCF< RPM t/min:s
* MACHINE MENU *

SELECT

اضغط على المفتاح

>RCF< RPM t/min:s
-> Info

START PULSE

اضغط على المفتاح.
طراز الجهاز.

>RCF< RPM t/min:s
BOECO SC-8

SELECT

مثال:
اضغط على المفتاح.
إصدار برنامج الجهاز.

>RCF< RPM t/min:s
CP FW= V02.00-05

SELECT

مثال:
اضغط على المفتاح.
Type#1 (نوع رقم 1): رقم نوع الجهاز.

>RCF< RPM t/min:s
Type#: 1800-13

SELECT

مثال:
اضغط على المفتاح.
Type#2 (النوع رقم 2): استمرار رقم التصنيف إذا كان له مواضع أكثر من حقل عرض "Type#1"

>RCF< RPM t/min:s
Type#2:

SELECT

مثال:
اضغط على المفتاح.
تاريخ تصنيع الجهاز

>RCF< RPM t/min:s
Date: 2017-09-12

SELECT

مثال:
اضغط على المفتاح.
رقم الجهاز التسلسلي.

>RCF< RPM t/min:s
Serial#: 0016234

SELECT

مثال:
اضغط على المفتاح.
نوع مغير التردد.

>RCF< RPM t/min:s
FC type LC 300VA

↓

مثال:

SELECT

اضغط على المفتاح.
إصدار برنامج مغير التردد.

>RCF< RPM t/min:s
FC FW= D 1.04



STOP
OPEN

اضغط على المفتاح مرتين للخروج من قائمة "Info"
(المعلومات) أو اضغط ثلاث مرات للخروج من
قائمة الآلة "* MACHINE MENU *"

>RCF< RPM t/min:s
* MACHINE MENU *

>RCF< RPM t/min:s
4500 5:00

مثال:

13.17 إشارة صوتية

تصدُر الإشارة الصوتية: (1) بعد حدوث عطل في فترة ثانيتين. (2) بعد إنهاء تشغيل الطرد المركزي والقاعدة الدوارة في حالة توقف تام في فترة 30 ثانية. يتم إنهاء الإشارة الصوتية عن طريق الضغط على أي مفتاح. إذا كانت القاعدة الدوارة في حالة توقف تام، يمكن ضبط الإشارة الصوتية على النحو التالي. يمكن إيقاف الإجراء في أي وقت عن طريق الضغط على المفتاح STOP OPEN. وفي هذه الحالة، لا يتم حفظ الإعدادات..

SELECT

اضغط مع الاستمرار على الزر ثمان ثوانٍ

>RCF< RPM t/min:s
* MACHINE MENU *

SELECT

اضغط على المفتاح حتى يظهر التالي

>RCF< RPM t/min:s
-> Settings



START
PULSE

اضغط على المفتاح.
End beep (صفارة النهاية): إشارة صوتية تصدر
بعد انتهاء تشغيل الطرد المركزي.
off (يقاف التشغيل): تم إيقاف تفعيل الإشارة.
on (لتشغيل): تم تفعيل الإشارة.

>RCF< RPM t/min:s
End beep =off

>RCF< RPM t/min:s
End beep =on

↓
t
▲ ▼

اضبط **off** أو **on** باستخدام المفاتيح

>RCF< RPM t/min:s
End beep =off

>RCF< RPM t/min:s
End beep =on

SELECT

اضغط على المفتاح.
Error beep (صفارة النهاية): إشارة صوتية تصدر
بعد حدوث عطل.
off (يقاف التشغيل): تم إيقاف تفعيل الإشارة.
on (لتشغيل): تم تفعيل الإشارة.

>RCF< RPM t/min:s
Error beep =off

>RCF< RPM t/min:s
Error beep =on

↓
t
▲ ▼

اضبط **off** أو **on** باستخدام المفاتيح

>RCF< RPM t/min:s
Error beep =off

>RCF< RPM t/min:s
Error beep =on



13.18 إشارة ضوئية بعد انتهاء تشغيل الطرد المركزي

تومض الإضاءة الخلفية للشاشة بعد تشغيل الطرد المركزي للإشارة بصرياً إلى أن تشغيل الطرد المركزي قد انتهى. يمكن تشغيل الإشارة الضوئية أو إيقاف تشغيلها عندما تكون القاعدة الدوارة في حالة توقف تام. يمكن إيقاف الإجراء في أي وقت عن طريق الضغط على المفتاح

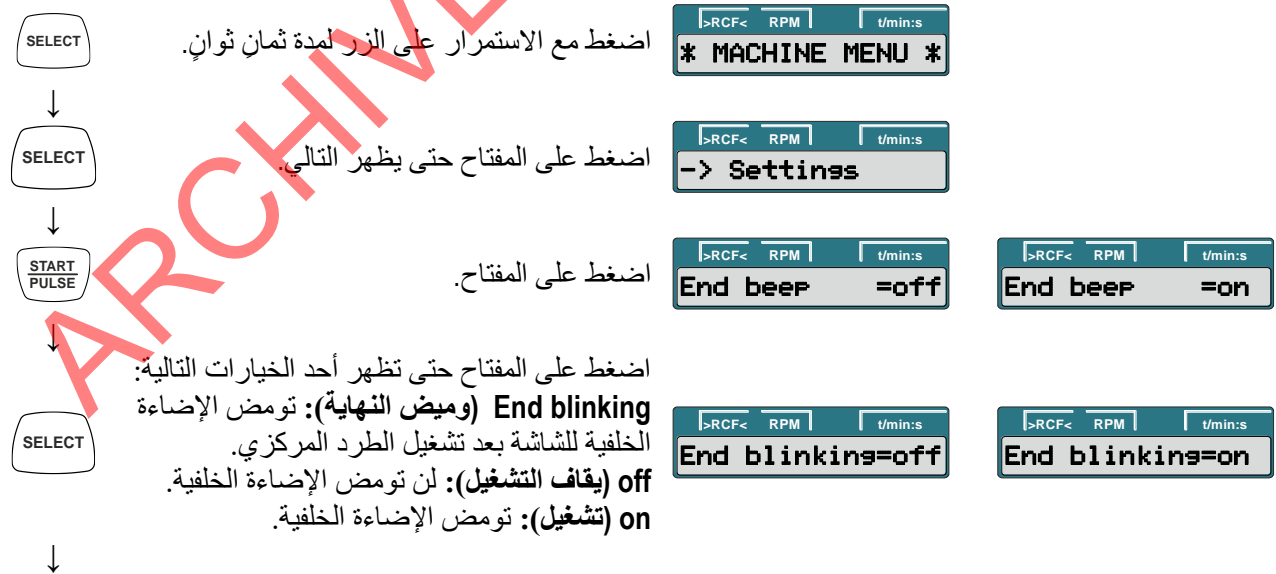

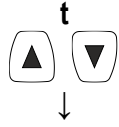

اضبط **off** أو **on** باستخدام المفاتيح

>RCF< RPM t/min:s
End blinking=off

>RCF< RPM t/min:s
End blinking=on

START PULSE

اضغط على الزر لحفظ الإعداد

>RCF< RPM t/min:s
Store settings...

>RCF< RPM t/min:s
-> Settings

STOP OPEN

اضغط على المفتاح مرة واحدة للخروج من قائمة "Settings" (الإعدادات) أو اضغط مرتين للخروج من "* MACHINE MENU *" (قائمة الآلة)

>RCF< RPM t/min:s
* MACHINE MENU *

>RCF< RPM t/min:s
4500 5:00

مثال:

13.19 الفتح التلقائي للغطاء بعد تشغيل الطرد المركزي

يمكن ضبط ما إذا كان يجب فتح الغطاء تلقائيًا أم لا وذلك بعد تشغيل الطرد المركزي. عندما تكون القاعدة الدوارة في حالة توقف تام، يمكن ضبط ذلك على النحو التالي. يمكن إيقاف الإجراء في أي وقت عن طريق الضغط على المفتاح . وفي هذه الحالة، لا يتم حفظ الإعدادات.

SELECT

اضغط مع الاستمرار على الزر لمدة ثمان ثوانٍ.

>RCF< RPM t/min:s
* MACHINE MENU *

SELECT

اضغط على المفتاح حتى يظهر التالي.

>RCF< RPM t/min:s
-> Settings

START PULSE

اضغط على المفتاح.

>RCF< RPM t/min:s
End beer =off

>RCF< RPM t/min:s
End beer =on

SELECT

اضغط على المفتاح حتى تظهر أحد الخيارات التالية:

>RCF< RPM t/min:s
Lid AutoOpen=off

>RCF< RPM t/min:s
Lid AutoOpen=on

Lid AutoOpen (الفتح التلقائي للغطاء): يفتح الغطاء تلقائيًا بعد تشغيل الطرد المركزي.
off (يوقف التشغيل): لا يتم فتح الغطاء تلقائيًا.
on (الاشتغيل): يتم فتح الغطاء تلقائيًا.



اضبط **off** أو **on** باستخدام المفاتيح.

>RCF< RPM t/min:s
Lid AutoOpen=off

>RCF< RPM t/min:s
Lid AutoOpen=on

START PULSE

اضغط على الزر لحفظ الإعداد.

>RCF< RPM t/min:s
Store settings...

>RCF< RPM t/min:s
-> Settings



اضغط على المفتاح مرة واحدة للخروج من قائمة "Settings" (إعدادات) أو اضغط مرتين للخروج من "MACHINE MENU" (قائمة الآلة).



مثال:

13.20 الإضاءة الخلفية للشاشة

لتوفير الطاقة، يمكن ضبط إطفاء الإضاءة الخلفية للشاشة بعد دقيقتين وذلك بعد تشغيل الطرد المركزي. عندما تكون القاعدة الدوارة في حالة توقف تام، يمكن ضبط ذلك على النحو التالي. يمكن إيقاف الإجراء في أي وقت عن طريق الضغط على المفتاح وفي هذه الحالة، لا يتم حفظ الإعدادات.



اضغط مع الاستمرار على الزر لمدة ثمان ثوانٍ.



اضغط على المفتاح حتى يظهر التالي.



اضغط على المفتاح.

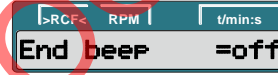

اضغط على المفتاح حتى تظهر أحد الخيارات التالية:
Power save (توفير الطاقة): إيقاف التلقائي للإضاءة الخلفية.
off (إيقاف التشغيل): تم إلغاء تنشيط إيقاف التلقائي.
on (التشغيل): تم تنشيط إيقاف التلقائي.

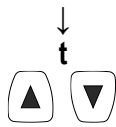

اضبط **off** أو **on** باستخدام المفاتيح.



اضغط على الزر لحفظ الإعداد.



اضغط على المفتاح مرة واحدة للخروج من قائمة "Settings" (إعدادات) أو اضغط مرتين للخروج من "MACHINE MENU" (قائمة الآلة).

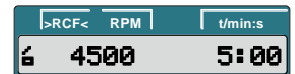

مثال:

13.21 الاستعلام عن ساعات التشغيل وعدد عمليات الطرد المركزي

تنقسم ساعات التشغيل إلى ساعات تشغيل داخلية وخارجية. ساعات التشغيل الداخلية: إجمالي الوقت الذي تم فيه تشغيل الجهاز. ساعات التشغيل الخارجية: إجمالي الوقت الذي تمت فيه عمليات الطرد المركزي السابقة. عندما تكون القاعدة الدوارة في حالة توقف تام، يمكن متابعة الاستعلام على النحو التالي يمكن إيقاف الإجراء في أي وقت عن طريق الضغط على

المفتاح 

اضغط مع الاستمرار على الزر لمدة ثمان ثوانٍ.







اضغط على المفتاح حتى يظهر التالي.

اضغط على المفتاح. مثال: TimeExt (الوقت الخارجي) : ساعات التشغيل الخارجية.

اضغط على المفتاح. مثال: TimeInt (الوقت الداخلي): ساعات التشغيل الداخلية.

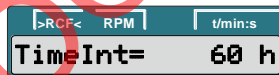
اضغط على المفتاح. مثال: Starts (عمليات البدء) : عدد عمليات تشغيل الطرد المركزي جميعها.

اضغط على المفتاح مرتين للخروج من قائمة "Time & Cycles" (الوقت والدورات) أو اضغط ثلاث مرات للخروج من "* MACHINE MENU *". مثال: قائمة الآلة

14 الأعطال

إذا كان لا يمكن التخلص من العطل بمساعدة جدول الأعطال أدناه ، يرجى الاتصال بخدمة العملاء وتحديد نوع جهاز الطرد المركزي والرقم التسلسلي. يمكن العثور على كلا الرقمين على لوحة اسم جهاز الطرد المركزي. تنفيذ إجراء MAINS RESET (إعادة ضبط التيار الكهربائي) : أوقف تشغيل مفتاح التيار الكهربائي (موضع التشغيل "0"). انتظر ما لا يقل عن 10 ثوانٍ ثم شغل مفتاح التيار الكهربائي مرة أخرى (موضع التشغيل "I").

الرسالة/ العطل	السبب	الحل
شاشة العرض لا تعمل	لا يوجد جهد كهربائي عطل بصمامات إدخال التيار الكهربائي.	<ul style="list-style-type: none"> تحقق من جهد التوزيع الكهربائي. تحقق من الصمامات إدخال التيار الكهربائي والرجوع إلى التعليمات لتغيير الصمامات الرئيسية. مفتاح التيار الكهربائي قيد التشغيل.

IMBALANCE (اختلال التوازن)		تم تعبئة القاعدة الدوارة بصورة غير متساوية.	<ul style="list-style-type: none"> - افتح الغطاء بعد توقف القاعدة الدوارة تمامًا. - تحقق من تعبئة القاعدة الدوارة - كرر عملية تشغيل الطرد المركزي.
MAINS INTER (تداخل التيار الكهربائي)	11	انقطاع التيار أثناء تشغيل الطرد المركزي. (لم تكتمل عملية تشغيل الطرد المركزي.)	<ul style="list-style-type: none"> - افتح الغطاء بعد توقف القاعدة الدوارة تمامًا. - اضغط على الزر start/pause - كرر عملية تشغيل الطرد المركزي إذا لزم الأمر.
MAINS INTERRUPT (انقطاع التيار الكهربائي)			
TACHO ERROR (خطأ TACHO)	1, 2	عطل بمحفزات السرعة أثناء التشغيل.	<ul style="list-style-type: none"> - أجرِ عملية MAINS RESET عندما تكون القاعدة الدوارة ثابتة.
LID ERROR (خطأ في الغطاء)	4.1 – 4.127	خطأ في قفل الغطاء أو غلق الغطاء.	
OVER SPEED (سرعة زائدة)	5	الدوران سريع للغاية	<ul style="list-style-type: none"> - أجرِ عملية MAINS RESET عندما تكون القاعدة الدوارة ثابتة.
VERSION ERROR (خطأ في الإصدار)	12	تم التعرف على طراز جهاز طرد مركزي غير صحيح. المواد الإلكترونية بها عطل / خطأ	
UNDER SPEED (دون السرعة الطبيعية)	13	الدوران بطيء للغاية	<ul style="list-style-type: none"> - أجرِ عملية MAINS RESET عندما تكون القاعدة الدوارة ثابتة.
CTRL ERROR (خطأ CTRL)	22.1, 25.2	المواد الإلكترونية بها عطل / خطأ	
CRC ERROR (خطأ CRC)	27.1		
COM ERROR (خطأ COM)	31 – 36		
FC ERROR (خطأ FC)	60, 61.1 – 61.21, 61.64 – 61.142		
FC ERROR (خطأ FC)	61.23	خطأ في قياس السرعة	<ul style="list-style-type: none"> - قد يتعذر إيقاف تشغيل الجهاز طالما أن مساحة عرض الدوران مضيئة وتدور. انتظر حتى يظهر رمز (الغطاء مقفل) (بعد حوالي 120 ثانية). ثم قم بإجراء عملية MAINS RESET.
TACHO ERR (خطأ TACHO)	61.22		
FC ERROR (خطأ FC)	61.153	المواد الإلكترونية بها عطل / خطأ	<ul style="list-style-type: none"> - قم بإجراء MAINS RESE. - تحقق من تحميل الدوار وفقًا للتعليمات المقدمة. - كرر عملية تشغيل الطرد المركزي.

15 قوة الطرد المركزي النسبية (RCF)

تقدم قوة الطرد المركزي النسبية (RCF) كمضاعف لتسارع الجاذبية. وتكون قيمة بلا وحدات وتعمل على مقارنة أداء الفصل والترسيب. تُمثل قوة الطرد المركزي النسبية (RCF) عدد الدورات في الدقيقة ونصف قطر الطرد المركزي. يمكن حسابه باستخدام الصيغة أدناه:

$$RCF = \left(\frac{RPM}{1000} \right)^2 \times r \times 1,118 \quad \Rightarrow \quad RPM = \sqrt{\frac{RCF}{r \times 1,118}} \times 1000$$

RCF = قوة الطرد المركزي النسبية
RPM = سرعة الدوران (الدورات في الدقيقة)
r = نصف قطر الطرد المركزي بالملم = المسافة بين مركز محور الدوران إلى أسفل حاوية جهاز الطرد المركزي

16 النقل والتخزين

قبل نقل الجهاز، يجب تركيب جهاز تأمين النقل. يمكن أن يتم تخزين الجهاز والملحقات في غرف مغلقة وجافة فقط. عند نقل أو تخزين الجهاز والملحقات، يجب الالتزام بالشروط التالية:
درجة الحرارة المحيطة: - 20 درجة مئوية إلى + 60 درجة مئوية
الرطوبة النسبية: 10% إلى 80%، مع عدم وجود تكاثف

17 تغيير صمامات إدخال التيار الكهربائي

ابدأ بإيقاف تشغيل مفتاح التيار الكهربائي وفصل الجهاز عن مصدر التيار الكهربائي. يقع حامل الصمامات (A) مع صمامات إدخال التيار الكهربائي بجانب مفتاح التيار الكهربائي. قم بفك كابل التوصيل من قابس التوصيل الخاص بالجهاز. اضغط على الفارسة ذاتية الإطباق (B) في مقابل حامل الصمامات (A) وأزلها. قم بتبديل صمامات إدخال التيار الكهربائي المعيبة. لا تستخدم إلا الصمامات ذات التصنيف المحدد لنوع جهاز الطرد المركزي الذي توفره الشركة المصنعة. أعد تركيب حامل الصمامات حتى غلق سقاطة الخاطف. أعد توصيل الجهاز بمصدر التيار الكهربائي.

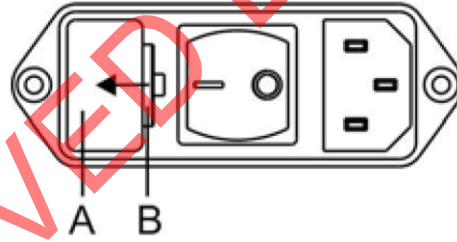

18 إعادة الأجهزة

قبل إعادة الجهاز، يجب تركيب جهاز تأمين النقل. إذا تم إرجاع الجهاز أو ملحقاته إلى شركة المصنعة القانونية، لتوفير الحماية للأشخاص والبيئة والمواد فيجب تطهيره وتنظيفها قبل شحنها. يحتفظ المصنع القانوني بالحق في رفض الأجهزة أو الملحقات الملوثة. يجب أن يتحمل العميل التكاليف المتكبدة للتنظيف والتطهير.

19 التخلص

قبل التخلص من الجهاز، يجب تطهيره وتنظيفه لحماية الأشخاص والبيئة، والممتلكات. عند التخلص من الجهاز، يجب مراعاة القواعد القانونية ذات الصلة. فوفقًا للمبدأ التوجيهي (WEEE) 2002/96/EC يُحظر التخلص من جميع الأجهزة التي تم تقديمها بعد 13 أغسطس 2005 كجزء من النفايات المنزلية. ينتمي الجهاز إلى المجموعة 8 (الأجهزة الطبية) ويتم تصنيفه في مجال معاملات الشركات. تُظهر أيقونة سلة المهملات المشطوبة أنه لا يجوز التخلص من الجهاز كجزء من النفايات المنزلية. قد تختلف إرشادات التخلص من النفايات الخاصة ببلدان المنفردة. يمكنك التواصل مع المورد الخاص بك في حالة الضرورة.



Poniższa tabela symboli ma jedynie charakter poglądowy. Odpowiednie symbole znajdują się na etykiecie opakowania produktu.

Symbol	Opis symbolu	Symbol	Opis symbolu
	Przeostroga		Pozycja początkowa
	Elektroniczna instrukcja obsługi		Nie stosować, jeśli opakowanie jest uszkodzone
	Producent		Wyrób medyczny
	Produkty BioHorizons są oznaczone symbolem CE i spełniają wymogi Dyrektywy dotyczącej wyrobów medycznych 93/42/EWG		Niesterylne
	Numer referencyjny/artykułu		Przechowywać w suchym miejscu
	Numer partii/serii		Kruchy; ostrożnie
	Nie używać ponownie		Limity temperatury
	Nie sterylizować ponownie.		Tędy w górę
	Termin ważności		Limity wilgotności
	Sterylizowane promieniowaniem gamma		Ostrzeżenie; Zagrożenie biologiczne
	Data produkcji		Ważne notatki
	Przeostroga: prawo federalne (USA) dopuszcza sprzedaż, dystrybucję i stosowanie tego wyrobu wyłącznie przez lekarza/dentystę lub na jego zlecenie		Oddzielna kolekcja urządzeń elektrycznych i elektronicznych.
			Upoważniony przedstawiciel UE

1 WSKAZANIA DO STOSOWANIA

System IntraSpin jest przeznaczony do bezpiecznego i szybkiego przygotowania autologicznej fibryny bogatej w leukocyty i płytki krwi (L-PRF) z małej próbki krwi w punkcie opieki pacjenta. L-PRF miesza się z autoprzeszczepem i / lub przeszczepem kości przed nałożeniem na ubytek kostny w celu poprawy właściwości manipulacyjnych. Przestrzeganie wszystkich informacji zawartych w instrukcji użytkowania jest również częścią zamierzonego zastosowania.

2 PRZECIWWSKAZANIA

Wirówka IntraSpin jest przeznaczona wyłącznie do celów określonych w przeznaczeniu urządzenia. Każde inne użycie urządzenia uważa się za niezgodne z przeznaczeniem. Używanie wirówki IntraSpin jest przeciwwskazane w przypadku wystąpienia co najmniej jednej z następujących sytuacji klinicznych: Pacjenci uzależnieni od alkoholu lub z zaburzeniami psychicznymi, dyskrazjami krwi, niekontrolowaną cukrzycą, nadczynnością tarczycy, infekcjami jamy ustnej, nowotworami złośliwymi lub pacjenci, którzy mieli zawał mięśnia sercowego w ciągu ostatniego 12 miesięcy. Pacjenci z chorobami ogólnoustrojowymi, które upośledzają układ odpornościowy, takimi jak AIDS, pacjenci przyjmujący leki, które mogłyby zagrozić gojeniu się implantu, pacjenci z historią złej lub nieprzestrzegania procedur higieny jamy ustnej.

Pacjenci biorący udział w terapii przeciwzakrzepowej. Tacy pacjenci nie są wykluczeni z korzyści płynących z PRF, lecz miejsce opieki musi poświęcić wirówce dodatkowy czas, aby separacja była skuteczna w użyciu.



3 UWAGI DOTYCZĄCE BEZPIECZEŃSTWA

- Producent nie będzie uznawał żadnego roszczenia gwarancyjnego, jeżeli nie będą przestrzegane WSZYSTKIE zalecenia zawarte w niniejszej instrukcji obsługi.
- Instrukcja obsługi jest częścią urządzenia. Zawsze muszą być łatwo dostępne. Jeśli urządzenie jest ustawione w innym miejscu, należy dołączyć do niego instrukcję obsługi.
- Wirówkę należy umieścić na solidnym, stabilnym podłożu.
- Przed zastosowaniem wirówki należy bezwzględnie sprawdzić wirnik pod kątem solidnego umieszczenia.
- Kiedy wirówka pracuje, zgodnie z normą EN / IEC 61010-2-020 w obszarze bezpieczeństwa wokół wirówki wynoszącym 300 mm nie mogą się znajdować żadne osoby, substancje niebezpieczne ani przedmioty.
- Nie wolno stosować dłużej wirników, zawieszek ani akcesoriów, które noszą ślady rdzy lub uszkodzeń mechanicznych lub których termin ważności upłynął.
- Wirówki nie należy już uruchamiać, kiedy komora wirowania ma uszkodzenia wpływające na bezpieczeństwo.
- W przypadku wirówek bez funkcji kontroli temperatury kiedy temperatura pomieszczenia zwiększy się i/lub urządzenie jest często używane, komora wirowania może się nagrzać. Nie można zatem wykluczyć, że materiał próbki może pod wpływem temperatury ulec zmianie.
- Przed pierwszym uruchomieniem wirówki należy przeczytać instrukcję obsługi i postępować ściśle według niej. Urządzenie mogą obsługiwać jedynie pracownicy, którzy przeczytali ze zrozumieniem instrukcję obsługi.
- Wraz z instrukcją obsługi i przepisami prawa w zakresie zapobiegania wypadkom należy również przestrzegać przyjętych regulacji zawodowych dotyczących wykonywania pracy w sposób bezpieczny i profesjonalny. Ta instrukcja obsługi obowiązuje wraz z wszelkimi innymi instrukcjami

dotyczącymi zapobiegania wypadkom i ochrony środowiska opartymi na przepisach krajowych obowiązujących w kraju, w którym urządzenie ma być stosowane.

- Wypełnianie obowiązujących w danym państwie wymogów dotyczących bezpieczeństwa pracy związanych z zastosowaniem w miejscach pracy wirówek zapewnianych przez użytkownika stanowi obowiązek użytkownika.
- Niniejsza wirówka jest najnowocześniejszym elementem wyposażenia i jest niezwykle bezpieczna w użyciu. Jednakże zastosowanie jej przez nieprzeszkolony personel w nieodpowiedni sposób lub w celu niezgodnym z jej przeznaczeniem może stwarzać zagrożenie dla użytkowników i innych osób.
- Wirówki nie wolno ruszać z miejsca ani przewracać w trakcie pracy.
- W przypadku błędu lub odryglowania awaryjnego nie wolno dotykać wirnika, zanim się nie zatrzyma.
- Aby uniknąć uszkodzenia spowodowanego skroplinami, przy zmianie pomieszczenia z zimnego na ciepłe wirówka musi przed podłączeniem do sieci nagrzewać się przez co najmniej 3 godziny w ciepłym pomieszczeniu lub pracować na gorąco przez 30 minut w pomieszczeniu zimnym.
- W przypadku wirowania przy maksymalnej ilości obrotów na minutę gęstość materiałów lub mieszanek materiałowych nie może przekraczać 1,2 kg/dm³.
- Wirówka może pracować wyłącznie, gdy równowaga mieści się w dopuszczalnych granicach.
- Nie wolno uruchamiać wirówki w obszarach zagrożonych wybuchem.
- Wirówki nie wolno używać z: materiałami łatwopalnymi lub wybuchowymi materiałami, które ze sobą reagują, wytwarzając dużą ilość energii.
- Dla tej wirówki nie są dostępne jakiegokolwiek systemy bezpieczeństwa biologicznego.
- Praca wirówki z substancjami silnie korodującymi, które mogłyby wpłynąć negatywnie na odporność mechaniczną wirników, wieszaków i akcesoriów, jest niedozwolona.
- Naprawy mogą być przeprowadzane wyłącznie przez osoby upoważnione przez producenta.
- Aby zapewnić najwyższy poziom bezpieczeństwa pacjentów w warunkach klinicznych, produkty firmy Intra-Lock są wytwarzane z materiałów biokompatybilnych z ludzkim osoczem..
- Produkt ten nie jest dopuszczony do sprzedaży na każdym rynku i może być niedostępny w niektórych krajach. Aby uzyskać dodatkowe informacje, należy skontaktować się z lokalnym przedstawicielem firmy Intra-Lock.

4 SKŁADNIKI SYSTEMU INTRASPIN

SKŁADNIK	ILOŚĆ NA SYSTEM
Wirówka IntraSpin, w tym:	1
Przewód zasilający	1
Bezpiecznik	2
Klucz ręczny sześciokątny	1
Greiner próbówki do pobierania krwi i próbówki do wirówek (jednorazowe).	150
Zestaw do pobierania krwi Greiner Safety + uchwyt, 21G (jednorazowego użytku)	24
Opaska uciskowa bez lateksu	1
Statyw na próbówki	1
Nożyczki chirurgiczne zakrzywione	1
Kleszczyki chirurgiczne	1
Okrągła misa ze stali nierdzewnej	1
Prostokątna misa ze stali nierdzewnej	1

Dual Biomaterial Carrier Spatula	1
Podwójny paker biomateriałów	1
Pojemnik Xpression®	1

Tylko sprawdzone kompatybilne komponenty do bezpośredniego użycia z wirówką IntraSpin są zalecane i gwarantowane:

CZEŚĆ ZGODNA #	OPIS
455092	Tubka 9 ml CAT Aktywator krzepnięcia surowicy, czerwona nasadka
455001	Probówka Z White Cap 9 ml bez dodatku
BHEXZ (E613)	Klucz sześciokątny IntraSpin, 110 i 220 V.
BROTORZ (E3694)	Wirnik IntraSpin, 100 V i 220 V.
BPOWER110Z (E1673)	Przewód zasilający IntraSpin, 110v
BPOWER220Z (E1669)	Przewód zasilający IntraSpin, 220v
BTUBEHOLDZ (E872 x 1)	Wymiana uchwytu rurki IntraSpin
BFUSE110Z (E997)	Bezpiecznik IntraSpin 110v
BFUSE220Z (E891)	Bezpiecznik IntraSpin 220v

5 KRÓTKA KONFIGURACJA CENTRIFUGE

Wyjmij i zapisz śruby transportowe z dolnej części wirówki.

Podłącz kabel prądu zmiennego i podłącz do gniazdka elektrycznego.

Włącz wirówkę za pomocą przełącznika z tyłu urządzenia.

Wybierz prędkość i czas: Prędkość = 2700 i czas = 12:00 min.

Nacisnąć przycisk START (Uruchom).

Pokrywa wirówki otworzy się automatycznie po zakończeniu każdego cyklu.

Po zakończeniu pierwszej procedury czas i prędkość cyklu są zapisywane w pamięci wirówki do czasu zmiany ustawień.

6 PRZESTROGI I INSTRUKCJE DOTYCZĄCE PROBÓWEK I ZESTAWÓW DO POBIERANIA KRWI

- Nie używać probówek, jeśli obecne są substancje obce.
- Należy pozwalać na całkowite wypełnienie probówek do pobierania krwi.
- Postępowanie z wszelkimi próbkami biologicznymi oraz przedmiotami ostrymi stosowanymi przy pobieraniu krwi (np. igłami i zestawami do pobierania krwi) powinno odbywać się zgodnie z zasadami i procedurami obowiązującymi w danej placówce.
- Nie zginać igły.
- Po aktywowaniu się mechanizmu ochrony igły nie zwalniać go na siłę ani nie wymuszać jego ponownej aktywacji.
- Uzyskać odpowiednią opiekę medyczną w przypadku jakiegokolwiek narażenia na próbki biologiczne (np. Przez obrażenia klute) z powodu możliwego przeniesienia HIV (AIDS), wirusowego zapalenia wątroby lub innych chorób zakaźnych.
- Wyrzucić wszystkie „ostre” narzędzia do pobierania krwi do zatwierdzonych pojemników stanowiących zagrożenie biologiczne.
- Przenoszenie próbki ze strzykawki do probówki nie jest zalecaną procedurą.

- Jeśli krew jest pobierana przez linię dożylną (IV), postępuj zgodnie z polityką i procedurami swojej instytucji, aby upewnić się, że linia została oczyszczona z roztworu IV przed rozpoczęciem napełniania probówek do pobierania krwi.
- Przyspieszacz krzepnięcia krwi może wydawać się biały na powierzchni probówki, co nie ma wpływu na działanie probówek. Jeśli w probówce występują jakiegokolwiek inne przebarwienia lub osady, nie należy jej używać.
- Nie należy używać probówek po upływie daty ważności.
- Probówki do pobierania krwi przechowywać w temperaturze 4–25°C (40–77°F).
- Zestaw do pobierania krwi (igłę i uchwyt) przechowywać w temperaturze 4–36°C (40–97°F).
- Unikaj narażenia na bezpośrednie działanie promieni słonecznych. Przekroczenie maksymalnej zalecanej temperatury przechowywania może prowadzić do pogorszenia jakości rurki (tj. Utraty próżni, zabarwienia itp.).
- Aby zapobiec przepływowi wstecznemu, ustaw ramię pacjenta w pozycji do dołu, przytrzymaj rurkę z nasadką do góry, zwolnij opaskę uciskową, gdy tylko krew zacznie płynąć do rurki, unikając kontaktu zawartości rurki z nasadką lub końcem igły podczas nakłucia.
- Przed wykonaniem nakłucia żyły należy upewnić się, że następujące materiały są łatwo dostępne: wszystkie niezbędne probówki do pobierania krwi, oznakowane etykiety do pozytywnej identyfikacji próbek pacjenta, igły i uchwyty do pobierania krwi, gazik nasączony alkoholem do oczyszczenia miejsca nakłucia, czysta gaza, opaska uciskowa lub plaster bandaży, zatwierdzony pojemnik na zagrożenia biologiczne. W celu ochrony przed narażeniem na patogeny przenoszone przez krew zaleca się stosowanie odpowiednich środków ochrony indywidualnej (np. Rękawiczek, fartucha laboratoryjnego, okularów itp.).

Technika Venipuncture i pobieranie próbek krwi:

Pobranie krwi należy wykonać jak najszybciej, ponieważ w probówkach nie ma antykoagulantu. Próbka krwi natychmiast zacznie się krzepnąć. Nosić rękawice podczas nakłuwania żyły i podczas obchodzenia się z probówkami do pobierania krwi, aby zminimalizować ryzyko narażenia. Przed pobraniem krwi wytrzyj górną część nasadki rurki krwi wybranymi chusteczkami dezynfekującymi. Zdjąć osłonę z sekcji zaworowej igły. Przygotuj miejsce nakłucia żyły za pomocą odpowiedniego środka antyseptycznego. Nie czyść palpacyjnie obszaru żyły po oczyszczeniu. Ustaw ramię pacjenta w pozycji dolnej. Zdejmij osłonkę igły. Wykonaj nakłucie z ramieniem skierowanym w dół i górną częścią nasadki rurki. W razie potrzeby unieruchomić igłę taśmą. Wepchnij rurkę do pobierania krwi do uchwytu i na zawór igłowy, przebijając gumową membranę rurki do pobierania krwi. Podczas penetracji nasadki wyśrodkuj probówki do pobierania krwi w uchwycie, aby zapobiec penetracji ściany bocznej i późniejszej przedwczesnej utracie próżni. Zdejmij opaskę uciskową, gdy tylko krew pojawi się w probówce do pobierania krwi. Podczas zabiegu zawsze trzymaj probówkę zbiorczą na miejscu, naciskając ją kciukiem. Zapewni to całkowite pobranie próżni. Probówka do pobierania krwi napełni się automatycznie. Jeśli krew nie przepływa do probówki lub przepływ krwi ustaje przed pobraniem odpowiedniej próbki, sugerowane są następujące kroki w celu ukończenia zadowalającego pobrania:

- Popchnąć probówkę do pobierania krwi do przodu, aby upewnić się, że korek został przebity.
- Potwierdzić prawidłowe położenie igły w żyłę.
- Jeśli krew nadal nie płynie, usunąć i odpowiednio zutylizować probówkę do pobierania. Wziąć nową probówkę do pobierania i popchnąć do uchwytu.

- Jeśli druga próbówka do pobierania nie pobiera krwi, usunąć i odpowiednio zutylizować igłę oraz próbówkę do pobierania. Powtórzyć procedurę.
- Po osiągnięciu linii maksymalnej objętości próbówki do pobierania krwi delikatnie wyjmij ją z uchwytu. Powtórz z drugą próbówką do pobierania krwi.

Delikatnie odwróć każdą próbówkę zbiorczą natychmiast po wyjęciu z uchwytu. Nie wstrząsać próbkami wypełnionymi próbką krwi. Energiczne mieszanie może powodować pienienie lub hemolizę. Niewystarczające mieszanie lub opóźnione mieszanie w próbkach z surowicą może powodować opóźnione krzepnięcie.

Po zakończeniu pobierania próbki krwi wyjąć igłę z żyły. Uaktywnić mechanizm ochrony (osłonę zabezpieczającą) igły, naciskając po obu stronach nasady, aby uaktywnić blokadę. Przesuwać mechanizm ochrony do tyłu, aż będzie słychać kliknięcie. Nie nakładać ponownie nasadki na igłę, ponieważ zwiększa to ryzyko zakłucia i narażenia na krew. Zużyta igłę wraz z uchwytem wyrzucić do odpowiedniego pojemnika na biologiczne odpady medyczne. Naciskaj miejsce nakłucia suchym jałowym wacikiem, aż krwawienie ustanie. W razie potrzeby zastosuj bandaż po wystąpieniu krzepnięcia. Zaleca się, aby wypełnione próbki zbiorcze były trzymane w pozycji pionowej. Gdy druga próbówka zostanie napełniona, wyjąć ją, a następnie umieścić pierwszą i drugą próbówkę w wirówce w przeciwległych pozycjach, aby zrównoważyć wirnik. Zamknąć pokrywę wirówki IntraSpin® i nacisnąć przycisk START (Uruchom) w celu rozpoczęcia cyklu wirowania trwającego 12 MINUT.

Jeśli potrzeba więcej niż dwóch próbek krwi, należy postąpić według tej procedury alternatywnej: po pobraniu krwi do dwóch pierwszych próbek i delikatnym odwróceniu ich do góry dnem natychmiast umieścić je w wirówce IntraSpin naprzeciwko siebie, aby zapewnić prawidłowe wyważenie wirówki. Zamknij pokrywę i naciśnij przycisk START i pozwól wirówce pracować podczas zbierania pozostałych próbek krwi. Naciśnij przycisk STOP i pozwól wirówce zatrzymać się całkowicie. Pokrywa otworzy się; natychmiast umieść pozostałe próbki w przeciwnej wirówce, aby zapewnić właściwą równowagę, i naciśnij przycisk START, aby zresetować i wykonać zalecany protokół.

Należy zawsze umieszczać próbki parami w przeciwległych pozycjach, aby zrównoważyć wirnik rotora. Należy zawsze zrównoważyć próbki w wirniku przed naciśnięciem przycisku START (Uruchom) – niezastosowanie się do tej instrukcji może prowadzić do poważnego uszkodzenia wirówki, nieprawidłowego krzepnięcia i/lub separacji. Jeśli próbki nie będą odpowiednio wyważone, wibracje będą występować podczas wirowania, co spowoduje słaby skrzep fibryny L-PRF.

Jeśli do odwirowania przeznaczona jest nieparzysta liczba próbek krwi, naprzeciwko próbki bez pary należy umieścić w wirówce próbówkę równoważącą z białą zatyczką (np. 455001) napełnioną wodą do wskazanej linii wypełnienia. Umożliwi to prawidłowe zrównoważenie wirówki.

Rozpocząć wirowanie natychmiast po pobraniu próbek krwi. Opóźnienia wpływają na procedurę oddzielania krwi i skutkują słabym skrzepem fibryny L-PRF.

7 PRZYGOTOWANIE MATRYCY L-PRF

Po odwirowaniu widoczne będą trzy segmenty:

1. Górny segment = osocze ubogopłytkowe (PPP).

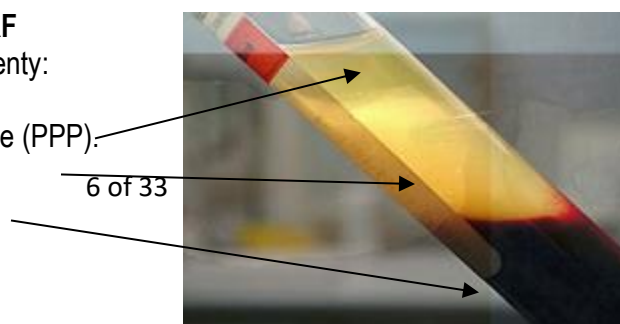

2. Środkowy segment = skrzep fibrynowy: L-PRF.
3. Dolny segment = skrzep z czerwonych krwinek.

Fibrynowe membrany lub zatyczki L-PRF muszą być przygotowane stosunkowo szybko: w ciągu 0–15 minut po odwirowaniu, ponieważ objętość skrzepu będzie się zmniejszać na skutek uwolnienia uwięzionej surowicy. Po odwirowaniu usuń gumowy korek z każdej probówki. Za pomocą kleszczy chirurgicznych usuń skrzep L-PRF z probówki. Delikatnie zeskocz skrzep czerwonych krwinek z skrzepu fibrynowego L-PRF® tuż poniżej zrostu, używając podwójnej szpachelki z nośnikiem biomateriałowym, tak aby do skrzepu L-PRF przyczepiona była tylko minimalna, resztkowa ilość czerwonych krwinek. Umieść skrzep fibrynowy na perforowanej tacy Xpression.

8 PRZYGOTOWANIE MASY FIBRYNOWEJ

Protokół nr1 Membrana L-PRF

Umieść każdy skrzep fibryny na perforowanej tacy Xpression. Po umieszczeniu wszystkich skrzepów fibrynowych, umieść płytkę kompresyjną Xpression i osłonę ważoną Xpression nad skrzepami fibrynowymi, nie wywierając żadnego nacisku na skrzepy.

Pod wpływem ciężaru pokrywy skrzep fibrynowy będzie powoli DOCISKANY, a wysięk będzie spływać przez filtr na spód tacy. Nie wywierać nacisku na obciążoną osłonę. Siła grawitacyjna na obciążonej osłonie delikatnie ściska skrzep i oddziela surowicę z skrzepu L-PRF bez uszkodzenia sieci fibryny.

Odczekaj co najmniej 5 minut przed usunięciem i użyciem jakichkolwiek błon fibrynowych. Nie usuwaj żadnych błon fibrynowych do czasu faktycznego użycia. Błona fibrynowa może pozostawać w Xpression Box przez okres do 3 godzin.



Protokół nr2 Wtyczka L-PRF

Włóż skrzep fibrynowy do białego cylindra produkcyjnego korka. Za pomocą tłoka powoli wciskaj skrzep wewnątrz białego cylindra do wytwarzania zatyczek L-PRF. Naciskać, aż górna krawędź tłoka zrówna się z górną krawędzią białego cylindra wykonanego z zatyczki L-PRF. Dzięki tej technice będzie można uformować grubą, okrągłą fibrynową zatyczkę dla gniazda ekstrakcyjnego. W przypadku pojedynczego

zęba jedna wtyczka L-PRF może być wystarczająca. Przedtrzonowe zęby mogą wymagać dwóch zatyczek L-PRF, a trzy zatyczki L-PRF mogą być potrzebne dla zębów trzonowych, w zależności od wielkości gniazda ekstrakcyjnego i wielkości utworzonego skrzepu fibrynowego.

Właściwości matrycy L-PRF® sprawiają, że stanowi ona doskonały preparat do stosowania w połączeniu z wybranym materiałem biologicznym. Zastosowanie dowolnego z poniższych protokołów mieszania pozwala na uwieszenie materiału biologicznego w matrycy fibrynowej, co ułatwia obchodzenie się z nim i jego biologiczne przetwarzanie.

Protokół nr3- Mieszanina materiału biologicznego i L-PRF

Aby uzyskać mieszaninę o konsystencji plasteliny, którą można delikatnie uformować za pomocą przyrządu do przetwarzania materiału biologicznego w celu uzyskania pożądanego kształtu i grubości, należy postępować zgodnie z poniższym protokołem: Delikatnie pociąć membranę fibrynową L-PRF na małe kawałki w sterylnym naczyniu za pomocą chirurgicznie zakrzywionych nożyczek. Dodać pożądaną ilość materiału z przeszczepu kostnego. Dokładnie wymieszać L-PRF® i materiał z przeszczepu kostnego. Tę mieszaninę można wprowadzić wady za pomocą szpachelki z podwójnym nośnikiem biomateriału.

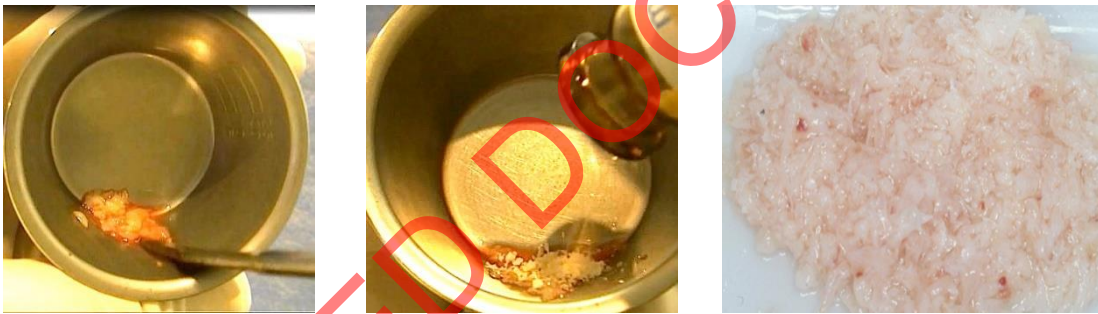

Protokół nr4- Mieszanina materiału biologicznego i matrycy L-PRF

Umieścić wstępnie określoną ilość materiału z przeszczepu kostnego w sterylnym naczyniu lub na tacy. Zanurzyć wyrażoną membranę lub fragmenty membrany L-PRF w przeszczepionym materiale pokrywającym całą powierzchnię membrany L-PRF za pomocą przeszczepionego materiału. Alternatywnie, przeszczepiony materiał można posypać membranę L-PRF pokrywającą całą powierzchnię przeszczepionym materiałem. Uwaga: bardziej wilgotna membrana L-PRF może zatrzymać nieco więcej materiału do wszczepienia niż membrana suszarki L-PRF. Przeszczepiony materiał powinien przylgnąć do powierzchni L-PRF, jednak w razie potrzeby delikatnie docisnąć przeszczepiony materiał do membrany L-PRF. Do umieszczenia tej mieszaniny w defekcie można użyć kleszczy chirurgicznych.

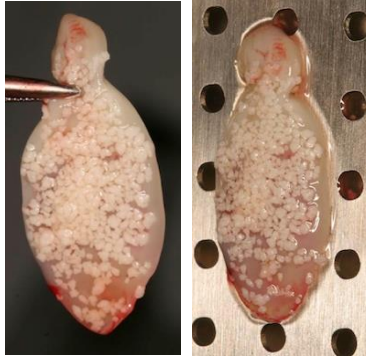

Protokół nr5- Hydratacja biomateriału

Dodaj żądaną ilość materiału do przeszczepu kości do sterylnej miski lub tacy. Użyj wysięku z dna tacki zbiorczej Xpression, aby nawodnić przeszczepiony materiał. Dokładnie wymieszaj wysięk z materiałem do przeszczepu kości. Tę mieszaninę można wprowadzić wady za pomocą szpachelki z podwójnym nośnikiem biomateriału.



9 ZESTAW DO REGENERACJI TKANEK CZYSZCZENIE I STERYLIZACJA

Pojemnik Xpression umożliwia łatwe wytwarzanie błon fibrynowych o stałej grubości. Wyciek można pobrać z tacki Xpression Collection, pod perforowaną tacą Xpression. Xpression Box zawiera cylindry do produkcji zatyczek L-PRF i tłok do wytwarzania wtyczek L-PRF, które łatwo pasują do gniazd poekstrakcyjnych.



Xpression Ważona okładka



Płyta kompresyjna Xpression



Perforowana taca Xpression na tacy zbierającej Xpression

Pojemnik Xpression i instrumenty pomocnicze NIE są dostarczane sterylne. Usuń i wyrzuć wszelkie materiały wysyłkowe przed pierwszą sterylizacją. Przed każdym użyciem wyczyść i wysterylizuj Pojemnik Xpression i instrumenty pomocnicze.

Rozłóż Pojemnik Xpression przed każdym cyklem czyszczenia i sterylizacji, aby uniknąć zalewania śmieci, odbarwienia się materiału i / lub nieodpowiedniego suszenia elementów. Cylindry do produkcji zatyczek L-PRF i przelotka tłoka nie są przeznaczone do wyjmowania z perforowanej tacy Xpression w celu czyszczenia i sterylizacji.

Czyszczenie: (1) Usuń wszelkie widoczne zanieczyszczenia ze składników Pojemnik Xpression i instrumentów pomocniczych za pomocą miękkiej szczotki z włosiem i środka do czyszczenia lub dezynfekcji o szerokim spektrum, takiego jak Enzymax® Hu-Friedy lub odpowiednik. Dokładnie spłucz. (2) Umieść elementy Pojemnik Xpression i instrumenty pomocnicze w odpowiednio dobranym pojemniku z tym samym roztworem i sonikuj przez 10 minut. Dokładnie spłucz. (3) Oplucz elementy Pojemnik Xpression i instrumenty pomocnicze alkoholem izopropylowym, aby usunąć wszelkie pozostałości mydła i minerały. (4) Osusz elementy Pojemnik Xpression i instrumenty pomocnicze niestrzępiącym się ręcznikiem i całkowicie wyschnij na powietrzu. Instrukcje użycia znajdują się na etykiecie użytego środka czyszczącego.

Steryliczacja: (1) Umieść ponownie zmontowaną skrzynkę Xpression i instrumenty pomocnicze w zatwierdzonym przez FDA worku do sterylizacji lub opakowaniu. (2) Przeprowadź jeden z następujących kwalifikowanych cykli sterylizacji:

Metoda sterylizacji	Temperatura	Czas narażenia	Minimalny czas suszenia
Para próżniowa (ANSI/AAMI ST79)	132°C (270°F)	4 minuty	20-30 minuty
Para próżniowa (UK DoH Health Technical Memorandum 01-01)	134°C (273°F)	3 minuty	20-30 minuty

Uwaga! Niewłaściwe czyszczenie może prowadzić do niewłaściwej sterylizacji. Niepowodzenie całkowitego wysuszenia elementów Pojemnik Xpression i instrumentów pomocniczych podczas sterylizacji w autoklawie może pozostawić wilgoć i spowodować odbarwienie i utlenienie. Zastosowanie nadtlenu wodoru lub innych środków utleniających spowoduje uszkodzenie powierzchni elementów Pojemnik Xpression i instrumentów pomocniczych. Zaleca się okresowe testowanie, czyszczenie i kalibrację sprzętu do autoklawu, aby upewnić się, że urządzenie pozostaje w dobrym stanie technicznym.

10 CZYSZCZENIE I KONSERWACJA ODŚRODKÓW

Urządzenie może być zanieczyszczone. Przed czyszczeniem wyciągnąć wtyczkę sieciową. Wirówek, wirników i akcesoriów nie wolno czyścić w zmywarkach. Dopuszczalne jest tylko czyszczenie ręczne i dezynfekcja płynem. Temperatura wody musi wynosić 20–25°C. Można stosować tylko detergenty / środki dezynfekujące o pH między 5 - 8, które nie zawierają żrących zasad, nadtlenu, związków chloru, kwasów i roztworów alkalicznych. Aby uniknąć powstawania korozji wskutek działania środków czyszczących i dezynfekujących, należy koniecznie przestrzegać wskazówek producenta środka czyszczącego i dezynfekującego dotyczących ich użycia.

Obudowę wirówki i komorę wirowania należy czyścić regularnie, używając mydła lub łagodnego detergentu i wilgotnej szmatki, jeśli jest to konieczne, aby zapobiec korozji przez przywierające zanieczyszczenia. Składniki odpowiednich detergentów obejmują mydło, anionowe środki powierzchniowo czynne i niejonowe środki powierzchniowo czynne. Po zastosowaniu środków czyszczących usunąć resztki środka czyszczącego, wycierając wilgotną ściereczką. Powierzchnie muszą zostać wysuszone bezpośrednio po czyszczeniu. W razie tworzenia się wody kondensacyjnej wysuszyć komorę wirowania, wycierając chłonną ściereczką. Na uszczelkę komory wirówki po każdym czyszczeniu należy nanieść cienką warstwę talku lub środka do konserwacji gumy. Komorę wirowania należy sprawdzić pod kątem uszkodzeń. W przypadku stwierdzenia uszkodzeń istotnych dla bezpieczeństwa nie wolno uruchamiać wirówki. W takim przypadku należy powiadomić dział obsługi klienta.

W przypadku dezynfekcji powierzchni materiały zakaźne wnikają do komory wirówkowej, należy je natychmiast zdezynfekować. Składniki odpowiednich środków dezynfekujących obejmują etanol, n-propanol, heksanol etylowy, anionowe środki powierzchniowo czynne i inhibitory korozji. Po zastosowaniu środków dezynfekcyjnych usunąć resztki środka dezynfekcyjnego, wycierając wilgotną ściereczką. Powierzchnie muszą być wysuszone bezpośrednio po dezynfekcji.

Aby usunąć zanieczyszczenia radioaktywne, środek musi być specjalnie oznakowany jako środek do usuwania zanieczyszczeń radioaktywnych. Składniki odpowiednich środków do usuwania radioaktywnych zanieczyszczeń obejmują anionowe środki powierzchniowo czynne, niejonowe środki powierzchniowo czynne, polihydratowany etanol. Po usunięciu zanieczyszczeń radioaktywnych usunąć resztki środka poprzez wytarcie wilgotną ściereczką. Powierzchnie muszą być wysuszone bezpośrednio po usunięciu zanieczyszczeń radioaktywnych.

11 WIRNIK I AKCESORIA CZYSZCZENIE I KONSERWACJA

Aby zapobiec korozji i zmianom w obrębie materiałów, wirniki i akcesoria czyścić regularnie za pomocą mydła lub łagodnego środka czyszczącego i wilgotnej ściereczki. Zaleca się czyszczenie co najmniej raz w tygodniu. Zanieczyszczenia muszą być usuwane natychmiast.

Składniki odpowiednich detergentów obejmują mydło, anionowe środki powierzchniowo czynne i niejonowe środki powierzchniowo czynne. Po zastosowaniu środków czyszczących usunąć resztki środka czyszczącego poprzez splukanie wodą (tylko z zewnątrz wirówki) lub wytarcie wilgotną ściereczką. Wirniki i akcesoria muszą być wysuszone bezpośrednio po czyszczeniu. Co tydzień sprawdzać wirnik i akcesoria pod kątem ewentualnego zużycia lub uszkodzeń korozyjnych. Wirnika i akcesoriów, które wykazują oznaki zużycia lub korozji, nie wolno już używać. Sprawdzać wirnik co tydzień pod kątem pewnego osadzenia. Jeżeli zainfekowany materiał przedostanie się na wirniki lub akcesoria, konieczne jest przeprowadzenie odpowiedniej dezynfekcji.

Składniki odpowiednich środków dezynfekujących obejmują etanol, n-propanol, heksanol etylowy, anionowe środki powierzchniowo czynne i inhibitory korozji. Po zastosowaniu środków dezynfekcyjnych usunąć resztki środka dezynfekcyjnego poprzez splukanie wodą (tylko z zewnątrz wirówki) lub wytarcie wilgotną ściereczką. Wirniki i akcesoria muszą być wysuszone bezpośrednio po dezynfekcji.

W celu usunięcia skażeń radioaktywnych środek musi być specjalnie oznakowany jako środek do usuwania skażeń radioaktywnych. Składniki odpowiednich środków do usuwania radioaktywnych zanieczyszczeń obejmują anionowe środki powierzchniowo czynne, niejonowe środki powierzchniowo czynne i polihydratowany etanol. Po usunięciu zanieczyszczeń radioaktywnych usunąć resztki środka poprzez splukanie wodą (tylko z zewnątrz wirówki) lub wytarcie wilgotną ściereczką. Wirniki i akcesoria muszą być wysuszone bezpośrednio po usunięciu zanieczyszczeń radioaktywnych.

Wirnik można sterylizować w autoklawie w temperaturze 121oC / 250oF przez 20 minut i odpowiednio wysuszyć. Po 10 cyklach autoklawowania wirnik ze względów bezpieczeństwa należy wymienić. Autoklawowanie przyspiesza proces starzenia tworzyw sztucznych i może powodować przebarwienia. Po autoklawowaniu poczekaj, aż wirnik ostygnie do temperatury otoczenia, zanim ponownie go użyjesz. Nie można wydać oświadczenia na temat klasy sterylności.

Okres użytkowania wirnika jest ograniczony do 50 000 cykli roboczych (wirowanie) lub 5 lat, w zależności od tego, co nastąpi wcześniej. Maksymalna dopuszczalna liczba cykli pracy jest podana na wirniku. Ze względów bezpieczeństwa nie wolno używać wirnika, jeżeli osiągnięta została (oznaczona na nim) maksymalna dopuszczalna liczba cykli pracy. Urządzenie wyposażono w licznik cykli, który liczy cykle pracy (cykle wirowania).

W przypadku pęknięcia rurki krwi wszystkie połamane części i krew należy całkowicie usunąć. Wirówka musi być dokładnie wyczyszczona zgodnie ze wskazaniami, a gumowe wkładki i plastikowe tuleje wirnika należy wymienić.

12 DANE TECHNICZNE ODŚRODKÓW

Typ modelu	IS220Z	IS110Z
Napięcie sieciowe ($\pm 10\%$)	200 - 240 V 1~	100 - 127 V 1~
Częstotliwość sieci	50 - 60 Hz-	50 - 60 Hz
Moc przyłączeniowa	100 VA	100 VA
Pobór prądu	0.5 A	1.0 A
Pojemność	8 x 10 ml	
Maksymalna dopuszczalna gęstość	1.2 kg/dm ³	
Maksymalna prędkość (obr./min)	6,000	
Siła odśrodkowa (RCF)	3,461	
Energia kinetyczna	750 Nm	
Miejsce konfiguracji	Tylko w pomieszczeniach	
Wysokość	Do 2000 m nad poziomem morza	
Temperatura otoczenia podczas pracy	od 5°C do 40°C	
Wilgotność względna podczas pracy	Maksymalna wilgotność względna wynosząca 80% w temperaturze do 31°C, malejąca liniowo do wilgotności względnej równej 50% w temperaturze 40°C.	
Kategoria przepięć	II	
Stopień zanieczyszczenia	2	
Klasa ochrony urządzenia	I	
	Nie nadaje się do stosowania w obszarach zagrożonych	
Emitowane zakłócenia, Odporność na	EN / IEC 61326-1, Klasa B	FCC Klasa B
Poziom hałasu (w zależności od wirnika)	≤ 50 dB(A)	
Szerokość wirówki	261 mm	
Głębokość wirówki	353 mm	
Wysokość wirówki	228 mm	
Waga wirówki	około 9 kg	

13 INSTRUKCJA OBSŁUGI ODŚRODKA

Konieczne jest usunięcie urządzenia zabezpieczającego transport, składającego się z 2 śrub (a) i 2 elementów (b) dystansowych. Zabezpieczenie transportowe należy zachować w bezpiecznym miejscu, ponieważ w przypadku ponownego transportu urządzenia musi ono zostać ponownie zamontowane. Urządzenie może być transportowane wyłącznie po zamontowaniu zabezpieczenia transportowego. W celu zabezpieczenia urządzenia przed uszkodzeniami na czas transportu silnik zostaje odpowiednio zamocowany. To zabezpieczenie transportowe należy usunąć przed uruchomieniem urządzenia.

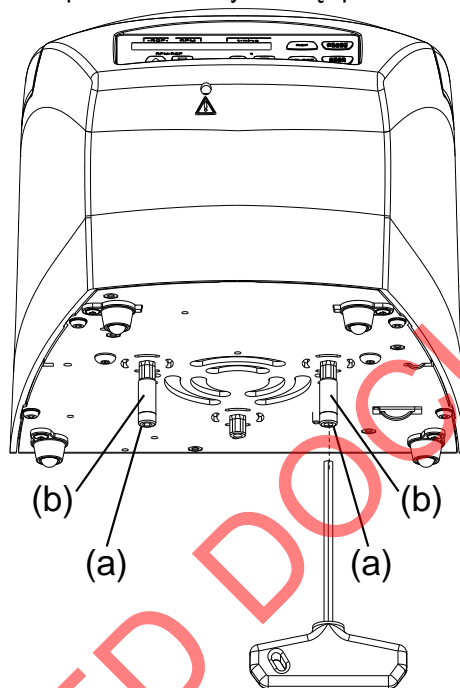

13.1 PIERWSZE URUCHOMIENIE

- Zdemontować zabezpieczenie transportowe od spodu wirówki.
- Ustawić wirówkę stabilnie w odpowiednim miejscu i wypoziomować. Gdy wirówka jest uruchomiona, żadne osoby, niebezpieczne substancje lub przedmioty nie mogą znajdować się w marginesie bezpieczeństwa wynoszącym 300 mm wokół wirówki.
- Otwory wentylacyjne nie mogą być zastawione. Należy zachować odstęp 300 mm od szczelin wentylacyjnych i otworów wentylacyjnych wirówki.
- Sprawdzić, czy napięcie sieciowe jest zgodne z podanym na tabliczce znamionowej.
- Podłączyć wirówkę kablem sieciowym do standardowego elektrycznego gniazda sieciowego.
- Włączyć włącznik sieciowy.
- Na panelu pojawiają się następujące ekrany: typ modelu wirówki, wersja oprogramowania i ostatnio użyte dane wirowania.
- Jeśli pokrywa jest zamknięta, pojawia się komunikat „Open the lid” (Otwórz pokrywę). Wówczas należy otworzyć pokrywę, aby wyświetlić dane wirowania.

13.2 OTWIERANIE I ZAMYKANIE POKRYWY ODŚRODKOWEJ

Pokrywę można otworzyć wyłącznie, gdy wirówka jest włączona, a wirnik zatrzymany. Jeśli licznik cykli jest aktywny, po cyklu wirowania podczas otwierania pokrywy przez krótki czas wyświetlana jest pozostała ilość cykli (cykli wirowania).



Przykład:



Aby otworzyć pokrywę, naciśnij następujący klawisz . Pokrywa jest odblokowywana przez silnik.

 wskazuje, że pokrywa jest odblokowana.



Przykład:

Nie wkładać palców pomiędzy pokrywą a obudowę. Nie zatrząskiwaj pokrywy.

Aby zamknąć pokrywę, delikatnie naciśnij przednią krawędź pokrywy.  wskazuje, że pokrywa jest zablokowana.



Przykład:

13.3 ODBLOKOWANIE AWARYJNE

W przypadku awarii zasilania, pokrywa nie może zostać odblokowana za pomocą silnika. Konieczne jest ręczne odblokowanie awaryjne. Aby odblokować w sytuacji awaryjnej, wyłącz wyłącznik zasilania (ustawienie przełącznika „0”). Spójrzeć poprzez okno w pokrywie, aby upewnić się, że wirnik jest nieruchomy. Pokrywę otwierać wyłącznie po zatrzymaniu wirnika. Wprowadzić klucz imbusowy poziomo w otwór (A) i ostrożnie obracać przeciwnie do ruchu wskazówek zegara (w lewo), aż pokrywa się otworzy. PRZESTROGA! Obracanie sześciokątnego klucza imbusowego w kierunku zgodnym z ruchem wskazówek zegara (w prawo) może uszkodzić system blokujący. Wyjąć klucz imbusowy ponownie z otworu.

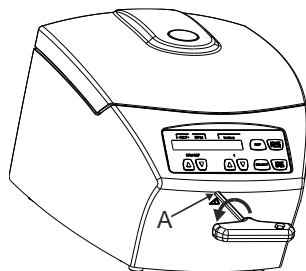

13.4 ZAKŁADANIE I ZDEJMOWANIE WIRNIKA

Aby usunąć wirnik, poluzować nakrętkę mocującą wirnika, obracając za pomocą klucza do wkrętów z sześciokątnym gniazdem zgodnie z ruchem wskazówek zegara (w zakresie dostawy) i obrócić aż do momentu rozporowego. Po przekroczeniu momentu rozporowego wirnik zwalnia się ze stożka wału silnika. Obrócić nakrętkę mocującą, aż wirnik da się podnieść z wału silnika. Podnieść wirnik z wału silnika.

Aby zainstalować wirnik, oczyścić wał silnika (A) i otwór wirnika, a następnie nanieść cienką warstwę smaru na wał silnika. Drobinki brudu między wałkiem silnika a wirnikiem uniemożliwiają dokładne osadzenie wirnika i powodują jego nierównomierną pracę. Założyć wirnik pionowo na wał silnika. Przy zakładaniu wirnika znacznik (B) na wirniku musi być ustawiony równoległe z obiema powierzchniami (C) na wale silnika. Dokręcić nakrętkę mocującą wirnika za pomocą klucza do wkrętów z sześciokątnym gniazdem (w zakresie dostawy), obracając zgodnie z ruchem wskazówek zegara. Sprawdzić wirnik, aby upewnić się, że jest pewnie osadzony.

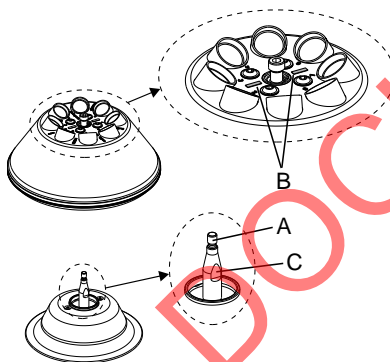

Wirniki muszą być ładowane symetrycznie. Probówki z krwią muszą być rozmieszczone równomiernie na wszystkich pozycjach wirnika.

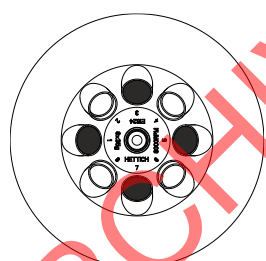

Wirnik jest załadowany równomiernie

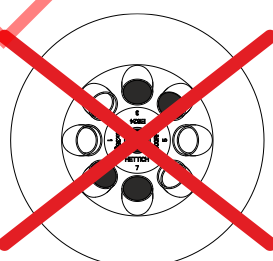

Wirnik jest załadowany nierównomiernie
Niedopuszczalne!

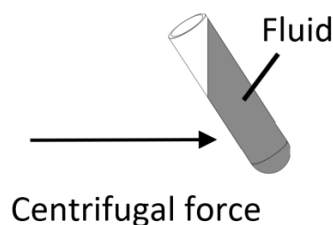

Probówki z krwią można napełniać wyłącznie poza wirówką. Maksymalna ilość napełnienia probówek z krwią jest podana na samych probówkach i nie może przekraczać maksymalnej masy podanej na rotorze. Pojemniki wirówki można wyłącznie napełnić w takim stopniu, aby w trakcie wirowania żadne ciecze nie były z nich odwirowywane podczas pracy wirówki. Podczas załadunku wirników kątowych żadna ciecz nie może wniknąć do wirnika ani do komory wirowania. Aby utrzymać różnice w masie w pojemniku wirówki na jak najniższym poziomie, zaleca się stały poziom napełnienia probówek z krwią.

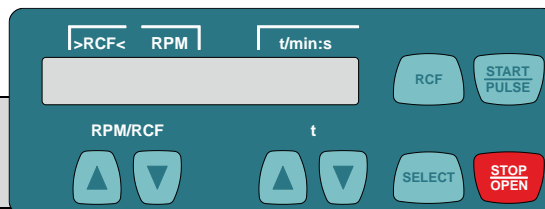

13.5 ELEMENTY WYŚWIETLACZA OPIS



Symbol / Klucz panelu	Opis
	Pokrywa odblokowana.
	Pokrywa zablokowana.
	Wskaźnik obrotu. Wskaźnik obrotu świeci się i obraca w kierunku przeciwnym do wskazówek zegara, gdy wirnik się obraca.
	Bezpośrednie wprowadzanie prędkości. Gdy przycisk jest wciśnięty, wartość zmienia się wraz z coraz większą prędkością.
	Bezpośrednie wprowadzanie czasu cyklu. Regulacja w krokach co 1 sekundę aż do jednej minuty oraz w krokach co 1 minutę, począwszy od 1 minuty. Wprowadzanie parametrów wirowania. Gdy przycisk jest wciśnięty, wartość zmienia się wraz z coraz większą prędkością.
	Aby aktywować poszczególne parametry. Za każdym przyciśnięciem tego przycisku aktywowany jest kolejny parametr. Przytrzymanie wciśnięty przycisk przez 8 sekund wywołać "MACHINE MENU" (Menu urządzenia). W „Machine Menu” (Menu urządzenia) można wybierać menu „-> Info” (Info) „-> Settings” (Ustawienia) i „-> Time & Cycles” (Czas i cykl). Przesuwanie do przodu w menu.
	Przełączanie między wyświetlaniem prędkości (RPM) a wyświetlaniem względnej siły odśrodkowej (>RCF<). Wartości RCF są wyświetlane między strzałkami> <.
	Uruchamianie cyklu wirowania. Wirowanie krótkotrwałe. Wirowanie odbywa się przez czas wciśnięcia przycisku. Aby wybrać menu "->Info" (Info), "->Settings" (Ustawienia) i "->Time & Cycles" (Czas i cykl).
	Kończenie cyklu wirowania. Zatrzymanie wirnika następuje zgodnie z ustawionym stopniem hamowania. Wciśnięcie przycisku dwa razy powoduje zatrzymanie awaryjne. Odblokowywanie pokrywy.
t/min (t/min)	Czas cyklu. Regulacja w zakresie 1–99 min, w krokach co 1 minutę.
t/sec (t/s)	Czas cyklu. Regulacja w zakresie 1–59 s, w krokach co 1 sekundę. Praca ciągła „--:--”. Ustawić parametry t/min i t/sec na zero.
Obr./min	Prędkość. Można ustawić wartość liczbową od 200 obr./min do maksymalnej prędkości wirnika. Regulacja w krokach co 10.
>RCF<	Względna siła odśrodkowa. Można ustawić wartość liczbową od 200 obr./min do maksymalnej prędkości wirnika. Regulacja w krokach co 1.

	Wprowadzenie względnej siły odśrodkowej (RCF) jest możliwe wyłącznie, jeśli aktywny jest wskaźnik RCF (>RCF<). Względna siła odśrodkowa (RCF) zależy od promienia wirowania (RAD). Po wprowadzeniu RCF należy sprawdzić, czy ustawiony został prawidłowy promień wirowania.
RAD/mm	Promień wirowania. Regulacja od 10 mm do 250 mm, w krokach co 1 mm. Wprowadzenie promienia wirowania jest możliwe wyłącznie, jeśli aktywny jest wskaźnik RCF (>RCF<).
~_DEC	Stopień hamowania. fast (szybki) = krótki czas wybiegu, slow (wolny) = długi czas wybiegu.

13.6 BEZPOŚREDNIE WPROWADZANIE PARAMETRÓW WIROWANIA

Prędkość obrotową (RPM), względną siłę odśrodkową (RCF), promień wirowania (RAD) i czas cyklu można wprowadzić bezpośrednio za pomocą przycisków   bez uprzedniej konieczności wciśnięcia przycisku . Ustawione parametry konfiguracji są przechowywane w pamięci wyłącznie po uruchomieniu cyklu wirowania.

Dla Prędkości (obr./min):



Wcisnąć przycisk, aby aktywować wskaźnik RPM / obr./min (RPM) według potrzeb.



Ustawić żądane wartości za pomocą przycisków.

Przykład:

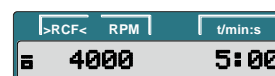
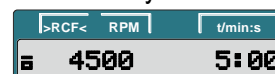

Względna siła odśrodkowa (RCF) i promień wirowania (RAD):



Wcisnąć przycisk, aby aktywować wskaźnik (>RCF<) według potrzeb.



Ustawić żądane wartości RCF za pomocą przycisków.

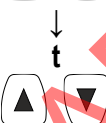

Ustawić żądany promień wirowania według potrzeb.

Przykład:

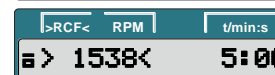
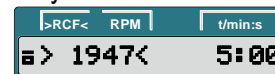

Czas cyklu:

Do 1 minuty czas cyklu można ustawić w krokach co 1 sekundę, a począwszy od 1 minuty można go ustawić tylko w krokach co 1 minutę. Aby ustawić pracę ciągłą, parametry **t/min** (t/min) i **t/sec** (t/s) należy ustawić na zero. Na wyświetlaczu czasu pojawia się (t/min:s), „--:--”.



t Ustawić żądane wartości za pomocą przycisków.



13.7 WPROWADZANIE PARAMETRÓW WIROWANIA ZA POMOCĄ PRZYCIŚKI „SELECT” (WYBIERZ)

Czas cyklu można ustawić również w minutach i sekundach (parametry **t/min (t/min)** oraz **t/sec (t/s)**). Aby ustawić pracę ciągłą, parametry **t/min** i **t/sec** należy ustawić na zero. Na wyświetlaczu czasu pojawia się (t/min:s), „--:--”.



Względne przyspieszenie wirowania (RCF) zależy od promienia wirowania (RAD). Podczas wprowadzania RCF wyświetlany jest promień wirowania. Jeżeli po wybraniu lub w trakcie wprowadzania parametrów nie zostanie naciśnięty żaden przycisk, na wskaźniku pojawiają się poprzednie wartości. Następnie trzeba ponownie wprowadzić parametry. Wciśnięcie przycisku służy do zapisania ustawień. Jeżeli wprowadzanych jest kilka parametrów, przycisk należy nacisnąć po ustawieniu ostatniego parametru. Wprowadzanie parametrów można w każdej chwili przerwać, naciskając przycisk . W tym przypadku ustawienia nie zostaną zapamiętane.

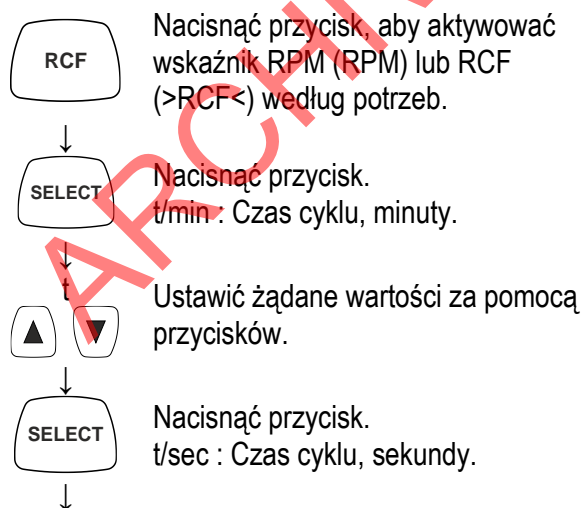

Przykład: Wskaźnik obr./min (RPM)

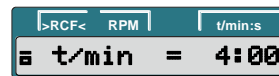
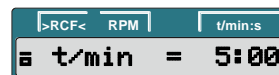
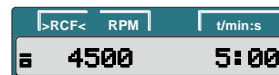

Przykład: Wskaźnik RCF (>RCF<)

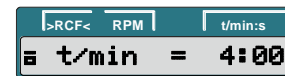
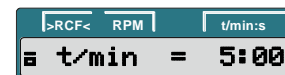
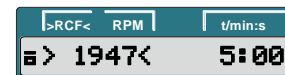

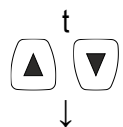
 Ustawić żądane wartości za pomocą przycisków.

>RCF<	RPM	t/min:s
▣	t/sec =	4:30

>RCF<	RPM	t/min:s
▣	t/sec =	4:30

 Nacisnąć przycisk.
 RPM : Prędkość.
 RAD/mm : Promień wirowania.
 Wyświetlanie i wprowadzanie promienia wirowania jest możliwe wyłącznie, jeśli aktywny jest wskaźnik RCF (>RCF<).

>RCF<	RPM	t/min:s
▣	RPM =	4500

>RCF<	RPM	t/min:s
▣	RAD/mm =	86

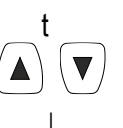

 Ustawić żądane wartości za pomocą przycisków.

>RCF<	RPM	t/min:s
▣	RPM =	4000

>RCF<	RPM	t/min:s
▣	RAD/mm =	67

 Nacisnąć przycisk.
 R : Promień wirowania.
 RCF : Względna siła odśrodkowa

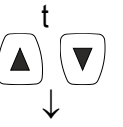
>RCF<	RPM	t/min:s
R:	67 RCF=	1947



 Ustawić żądane wartości za pomocą przycisków.

>RCF<	RPM	t/min:s
R:	67 RCF=	1198

 Nacisnąć przycisk.
 _DEC: Stopień hamowania.
 fast (szybki) : krótki czas wybiegu.
 slow (wolny) : długi czas wybiegu.

>RCF<	RPM	t/min:s
▣	_DEC =	slow

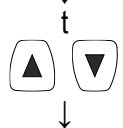
>RCF<	RPM	t/min:s
▣	_DEC =	slow

 Ustawić żądane wartości za pomocą przycisków.

>RCF<	RPM	t/min:s
▣	_DEC =	fast

>RCF<	RPM	t/min:s
▣	_DEC =	fast

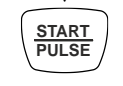
 Nacisnąć przycisk, aby zachować ustawienia.

>RCF<	RPM	t/min:s
▣	4000	4:30

>RCF<	RPM	t/min:s
▣	> 1198<	4:30



13.8 WYŚWIETLACZ PANELU STERUJĄCEGO

Po każdym cyklu wirowania podczas odblokowywania pokryw przez krótki czas wyświetlana jest pozostała ilość cykli (cykli wirowania).

Przykład: 

W przypadku przekroczenia dopuszczalnej różnicy masy w obrębie ładunku wirnika, cykl wirowania zostaje przerwany podczas rozruchu pojawi się „IMBALANCE”.

Przykład: 

Cykl wirowania można w każdej chwili przerwać, naciskając przycisk . Podczas cyklu wirowania można wybierać i zmieniać parametry wirowania. Zmienione wartości mają jednak zastosowanie wyłącznie do bieżącego cyklu wirowania i nie są zapamiętywane. Za pomocą przycisku  można w dowolnym momencie przełączać pomiędzy wskaźnikiem obr./min (RPM) a wskaźnikiem RCF (>RCF<). W przypadku pracy ze wskaźnikiem RCF (>RCF<) należy wprowadzić promień wirowania. Wówczas dalsza obsługa wirówki jest możliwa dopiero po otwarciu pokrywy. Wyświetlane są błędy obsługi i zakłócenia.

Przykład: 

13.9 WIROWANIE Z ZAPROGRAMOWANYM CZASEM

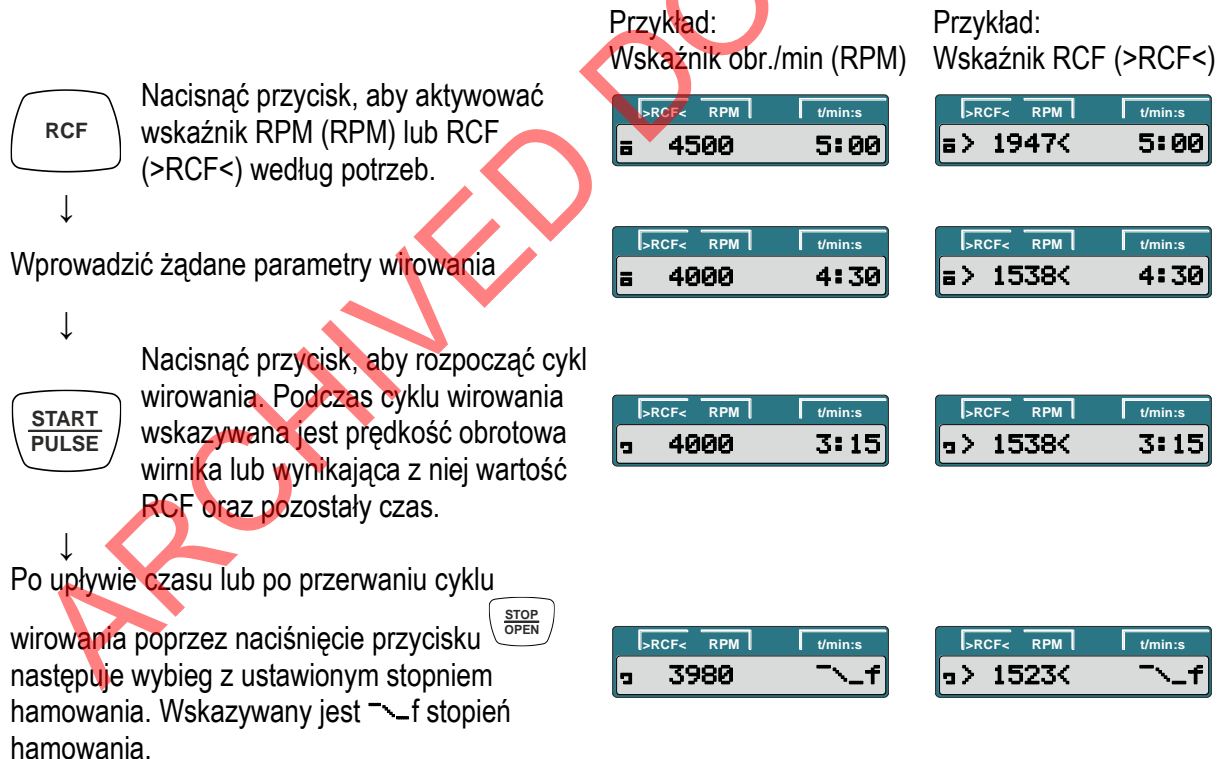

13.10 PRACA CIĄGLA



Nacisnąć przycisk, aby aktywować wskaźnik RPM (RPM) lub RCF (>RCF<) według potrzeb.



Wprowadzić żądane parametry wirowania. Ustawić parametry t/min (t/min) and t/sec (t/s) na zero



Nacisnąć przycisk, aby rozpocząć cykl wirowania. Podczas cyklu wirowania wskazywana jest prędkość obrotowa wirnika lub wynikająca z niej wartość RCF oraz pozostały czas.



Nacisnąć przycisk, aby zakończyć cykl wirowania. Wybieg następuje z ustawionym stopniem hamowania. Wskazywany jest \sim f stopień hamowania.

13.11 WIROWANIE KRÓTKOTRWAŁE



Nacisnąć przycisk, aby aktywować wskaźnik RPM (RPM) lub RCF (>RCF<) według potrzeb.



Wprowadzić żądane parametry wirowania



Nacisnąć przycisk i przytrzymać wciśnięty. Podczas cyklu wirowania wskazywana jest prędkość obrotowa wirnika lub wynikająca z niej wartość RCF oraz czas, który upłynął.



Zwolnić ponownie przycisk, aby zakończyć cykl wirowania. Wybieg następuje z ustawionym stopniem hamowania. Wskazywany jest \sim f stopień hamowania.

Przykład:
Wskaźnik obr./min (RPM)

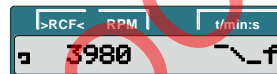
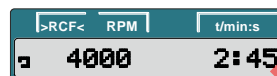
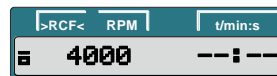
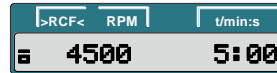

Przykład:
Wskaźnik RCF (>RCF<)

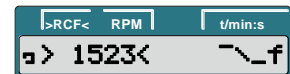
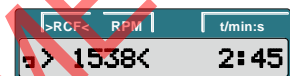

Przykład:
Wskaźnik obr./min (RPM)

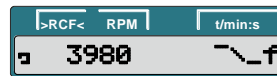
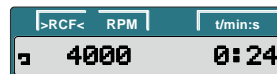
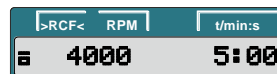

Przykład:
Wskaźnik RCF (>RCF<)

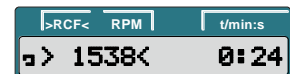
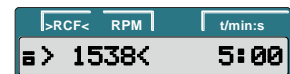

13.12 WYŁĄCZENIE AWARYJNE



Nacisnąć przycisk dwa razy. Podczas wyłączenia awaryjnego wybieg następuje ze stopniem hamowania „fast” (szybki) (krótki czas wybiegu). Wskazywany jest ~f stopień hamowania.

Przykład:
Wskaźnik obr./min (RPM)



Przykład:
Wskaźnik RCF (>RCF<)



13.13 LICZNIK CYKLI

Wirówka jest wyposażona w licznik cykli, który liczy cykle pracy (cykle wirowania). Po każdym cyklu wirowania podczas odblokowywania pokrywy przez krótki czas wyświetlana jest pozostała ilość cykli (cykli wirowania).

Przykład:



Jeżeli przekroczona jest maksymalna liczba dopuszczalnych cykli pracy wirnika, po każdym uruchomieniu cyklu wirowania pojawia się następujące wskazanie i trzeba ponownie uruchomić cykl wirowania. Ze względów bezpieczeństwa wirnik należy natychmiast wymienić na nowy. Po wymianie wirnika należy z powrotem ustawić licznik cykli do wartości „0”.

Przykład:



13.14 ZEROWANIE LICZNIKA CYKLI

Po wymianie wirnika należy z powrotem wyzerować licznik cykli. Licznik cykli wolno zerować wyłącznie wówczas, jeżeli uprzednio wymieniono wirnik na nowy. Licznik cykli można zresetować podczas przestoju wirnika w następujący sposób. Procedurę można w każdej chwili przerwać, naciskając przycisk . W tym przypadku ustawienia nie zostaną zapamiętane.



Nacisnąć i przytrzymać przycisk przez osiem sekund.



Naciskać przycisk, aż pojawi się następujące wskazanie.



Nacisnąć przycisk.

Przykład:



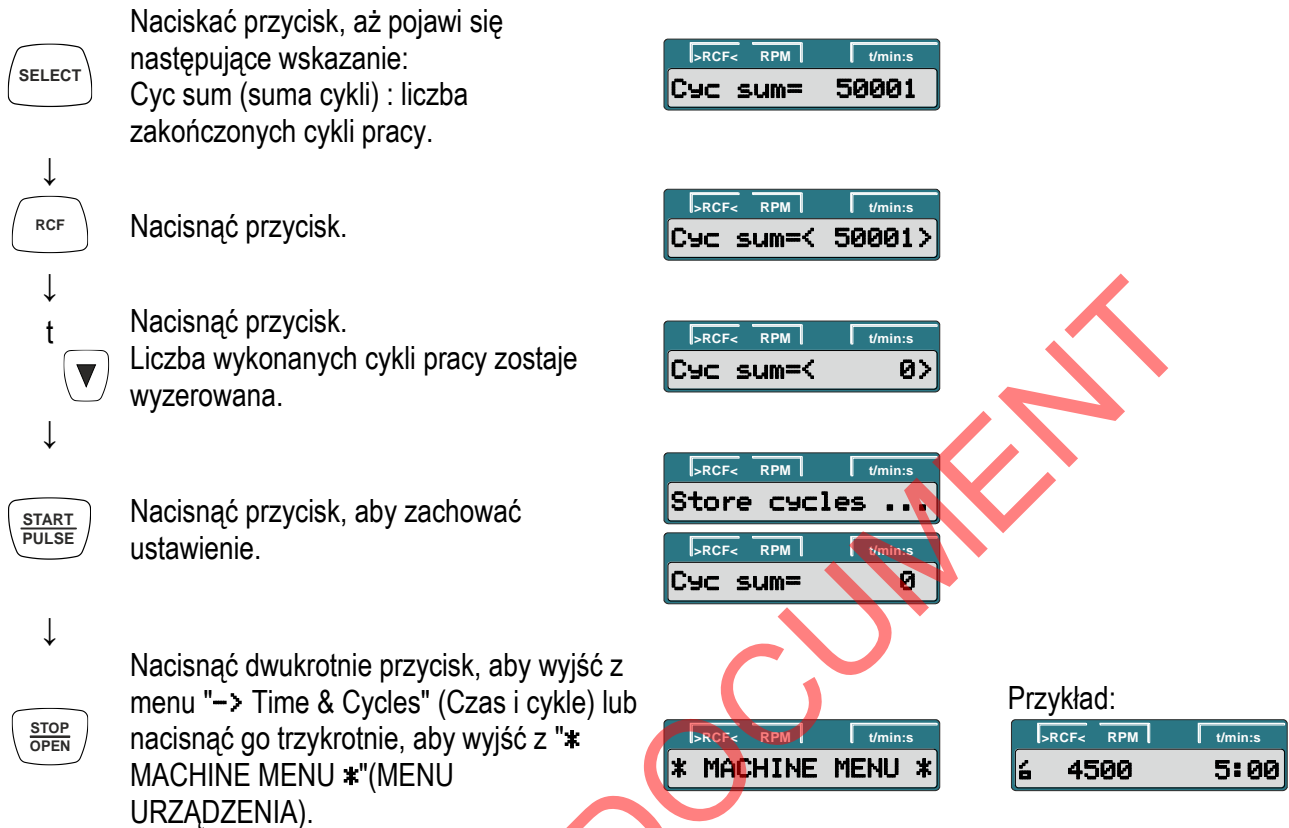

13.15 USTAWIENIA I ODPYTYWANIE DANYCH

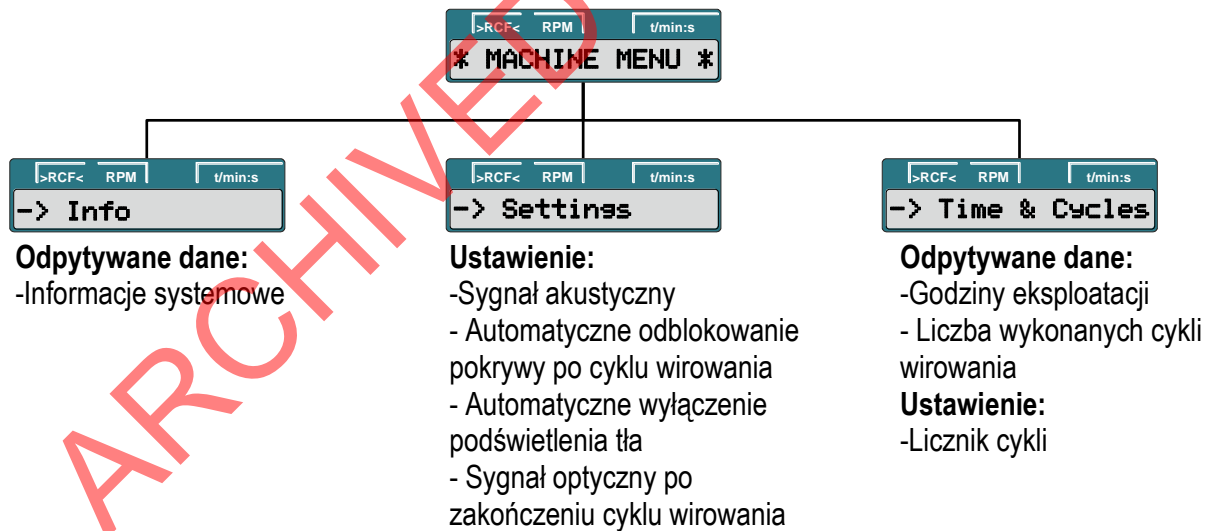



13.16 ODPYTYWANIE INFORMACJI SYSTEMOWYCH

Można odpytywać następujące informacje systemowe:

- Model urządzenia,
- Wersja programu urządzenia,

- Numer typu urządzenia,
- Data produkcji urządzenia,
- Numer seryjny urządzenia,
- Typ falownika,
- Wersja programu falownika.

Odpytywanie odbywa się w sposób następujący po zatrzymaniu wirnika: Procedurę można w każdej chwili przerwać, naciskając przycisk .

 Nacisnąć i przytrzymać przycisk przez osiem sekund.



↓
 Nacisnąć przycisk.



↓
 Nacisnąć przycisk.
Model urządzenia.



↓
 Nacisnąć przycisk.
Wersja programu urządzenia.

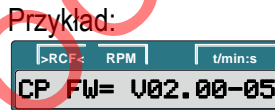

↓
 Nacisnąć przycisk.
Type#1 (Nr typu 1) : Numer typu urządzenia.



↓
 Nacisnąć przycisk.
Type#2 (Nr typu 2) : Kontynuacja numeru typu, jeśli jest więcej pozycji niż obejmuje pole wskaźnika „Type#1”.



↓
 Nacisnąć przycisk.
Data produkcji urządzenia.

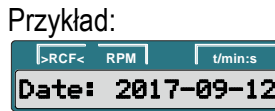

↓
 Nacisnąć przycisk.
Numer seryjny urządzenia.



↓
 Nacisnąć przycisk.
Typ falownika.

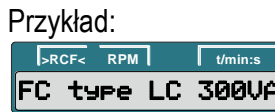



Nacisnąć przycisk.
Wersja programu falownika.



Nacisnąć dwukrotnie przycisk, aby wyjść z menu "-> Info" (Info) lub nacisnąć go trzykrotnie, aby wyjść z "* MACHINE MENU (MENU URZĄDZENIA)*".

Przykład:

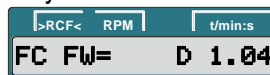

Przykład:

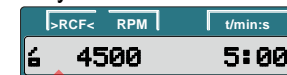

13.17 SYGNAŁ AKUSTYCZNY

Sygnal akustyczny rozlega się: (1) po wystąpieniu usterki w odstępie 2 sekund. (2) po zakończeniu cyklu wirowania i zatrzymaniu wirnika w odstępie 30 sekund. Po naciśnięciu dowolnego przycisku sygnal akustyczny zostanie zakończony. Sygnal akustyczny można nastawić podczas przestoju wirnika w następujący sposób. Procedurę można w każdej chwili przerwać, naciskając przycisk . W tym przypadku ustawienia nie zostaną zapamiętane.



Nacisnąć i przytrzymać przycisk przez osiem sekund.



Naciskać przycisk, aż pojawi się następujące wskazanie.



Nacisnąć przycisk.
End beep (Sygnal zakończenia) : sygnal akustyczny po zakończeniu cyklu wirowania.
off (wył.) : sygnal nieaktywny.
on (wł.) : sygnal aktywny.

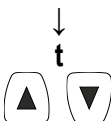

Ustawić przyciskami **off** lub **on**.



Nacisnąć przycisk.
Error beep (Sygnal błędu) : sygnal akustyczny po wystąpieniu usterki.
off : sygnal nieaktywny.
on : sygnal aktywny.

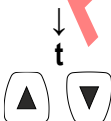

Ustawić przyciskami **off** lub **on**.





Nacisnąć przycisk.
Beep volume (głośność sygnału) :
 głośność sygnału akustycznego.
min (min.) : cichy
mid (śr.) : średni
max (gł.) : głośny

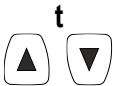
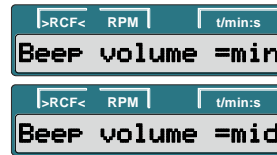

Ustawić przyciskami **min**, **mid** lub **max**.



Nacisnąć przycisk, aby zachować ustawienie.



Nacisnąć raz przycisk, aby wyjść z menu "**-> Settings**" (Ustawienia) lub nacisnąć go trzykrotnie, aby wyjść z "*** MACHINE MENU ***" (MENU URZĄDZENIA)."



Przykład:

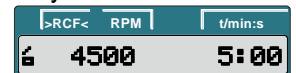

13.18 SYGNAŁ OPTYCZNY PO ZAKOŃCZENIU CYKLU WIROWANIA

Podświetlenie tła wskaźnika miga po cyklu wirowania, sygnalizując optycznie, że został zakończony cykl wirowania. Sygnał optyczny można włączyć lub wyłączyć podczas przestoju wirnika w następujący sposób.

Procedurę można w każdej chwili przerwać, naciskając przycisk .



Nacisnąć i przytrzymać przycisk przez osiem sekund.



Naciskać przycisk, aż pojawi się następujące wskazanie.



Nacisnąć przycisk.



Naciskać przycisk, aż pojawi się jedno z poniższych wskazań.
End blinking (miganie końcowe) : miganie podświetlenia wskaźnika po cyklu wirowania.
off (wył.) : podświetlenie tła nie miga.
on (wł.) : podświetlenie tła miga.



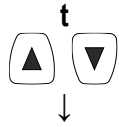

Ustawić przyciskami **off** lub **on**.



Nacisnąć przycisk, aby zachować ustawienie.



Nacisnąć raz przycisk, aby wyjść z menu " -> Settings" (Ustawienia) lub nacisnąć go trzykrotnie, aby wyjść z "* MACHINE MENU *" (MENU URZĄDZENIA) *".



Przykład:



13.19 AUTOMATYCZNE ODBLOKOWANIE POKRYWY PO CYKLU WIROWANIA

Można ustawić, czy pokrywa ma być odblokowywana automatycznie po cyklu wirowania, czy też nie. Można to ustawić podczas przestoju wirnika w następujący sposób. Procedurę można w każdej chwili przerwać, naciskając przycisk . W tym przypadku ustawienia nie zostaną zapamiętane.



Nacisnąć i przytrzymać przycisk przez osiem sekund.



Naciskać przycisk, aż pojawi się następujące wskazanie.



Nacisnąć przycisk.



Naciskać przycisk, aż pojawi się jedno z poniższych wskazań.

Lid AutoOpen (autootwieranie pokrywy) : automatyczne odblokowanie pokrywy po cyklu wirowania.

off (wyl.) : pokrywa nie odblokowuje się automatycznie.

on (wl.) : pokrywa odblokowuje się automatycznie.

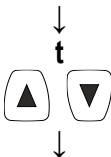

Ustawić przyciskami **off** lub **on**.





Nacisnąć przycisk, aby zachować ustawienie.

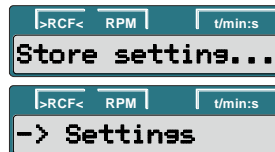

Nacisnąć raz przycisk, aby wyjść z menu "-> Settings" (Ustawienia) lub nacisnąć go trzykrotnie, aby wyjść z "*MACHINE MENU (MENU URZĄDZENIA)*".



Przykład:



13.20 PODŚWIETLENIE TŁA WSKAŹNIKA

Aby oszczędzać energię, można ustawić, aby po cyklu wirowania podświetlenie tła wskaźnika gasło po 2 minutach. Można to ustawić podczas przestoju wirnika w następujący sposób. Procedurę można w każdej chwili przerwać, naciskając przycisk . W tym przypadku ustawienia nie zostaną zapamiętane.



Nacisnąć i przytrzymać przycisk przez osiem sekund.



Naciskać przycisk, aż pojawi się następujące wskazanie.

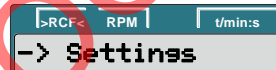

Nacisnąć przycisk.



Naciskać przycisk, aż pojawi się jedno z poniższych wskazań.



Power save (oszczędzanie energii) :
off (wyl.) : automatyczne wyłączenie podświetlenia tła nieaktywne.
on (wl.) : automatyczne wyłączenie aktywne.



Ustawić przyciskami **off** lub **on**.



Nacisnąć przycisk, aby zachować ustawienie.

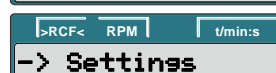





Nacisnąć raz przycisk, aby wyjść z menu " -> Settings" (Ustawienia) lub nacisnąć go trzykrotnie, aby wyjść z "* MACHINE MENU (MENU URZĄDZENIA) *".

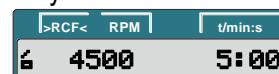

Przykład:



13.21 ODPYTYWANIE GODZIN EKSPLOATACJI ORAZ LICZBY CYKLI WIROWANIA

Godziny eksploatacji dzielą się na godziny wewnętrzne i zewnętrzne eksploatacji. Wewnętrzne godziny eksploatacji: Całkowity czas, przez jaki urządzenie było włączone. Zewnętrzne godziny eksploatacji: Całkowity czas dotychczasowych cykli wirowania. Odpytywanie odbywa się w sposób następujący po zatrzymaniu wirnika. Procedurę można w każdej chwili przerwać, naciskając przycisk 



Nacisnąć i przytrzymać przycisk przez osiem sekund.



Naciskać przycisk, aż pojawi się następujące wskazanie.



Nacisnąć przycisk.

TimeExt (czas zewn.) : zewnętrzne godziny eksploatacji.

Przykład:

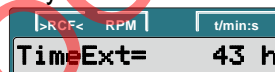

Nacisnąć przycisk.

TimeInt (czas wewn.) : wewnętrzne godziny eksploatacji.

Przykład:



Nacisnąć przycisk.

Starts (uruchomienia) : liczba wszystkich cykli wirowania.

Przykład:



Nacisnąć dwukrotnie przycisk, aby wyjść z menu " -> Time & Cycles" (Czas i cykle) lub nacisnąć go trzykrotnie, aby wyjść z "* MACHINE MENU *" (MENU URZĄDZENIA).



Przykład:



14 BŁĘDY

Jeśli usterki nie można usunąć za pomocą poniższej tabeli błędów, należy skontaktować się z obsługą klienta i podać typ wirówki oraz numer seryjny. Oba numery widoczne są na tabliczce znamionowej wirówki. Wykonać MAINS RESET (RESET SIECIOWY): Wyłączyć włącznik sieciowy (pozycja włącznika „0”). Odczekać co najmniej 10 sekund, a następnie ponownie włączyć włącznik sieciowy (pozycja włącznika „1”).

Komunikat/błąd	Przyczyna	Rozwiązanie
----------------	-----------	-------------

Brak wskazania		Brak napięcia Uszkodzone bezpieczniki wejściowe sieci.	<ul style="list-style-type: none"> – Sprawdzić napięcie zasilające. – Sprawdź bezpiecznik zasilania sieciowego i zapoznaj się z instrukcją wymiany bezpiecznika sieciowego. – Włącznik sieciowy w pozycji ON (WŁ.).
IMBALANCE (NIEWYWAŻENIE)		Wirnik jest załadowany nierównomiernie.	<ul style="list-style-type: none"> – Otworzyć pokrywę po zatrzymaniu wirnika. – Sprawdzić załadowanie wirnika. – Powtórzyć cykl wirowania.
MAINS INTER (PRZER. SIECIOWE)	11	Usterka zasilania podczas cyklu wirowania. (Cykl wirowania nie został zakończony.)	<ul style="list-style-type: none"> – Otworzyć pokrywę po zatrzymaniu wirnika. – Wcisnąć przycisk start/pause. – W razie potrzeby powtórzyć cykl wirowania.
MAINS INTERRUPT (PRZERWANIE SIECIOWE)			
TACHO ERROR (BŁĄD TACHOGRAFU)	1, 2	Błąd związany z impulsem prędkości obrotowej.	<ul style="list-style-type: none"> – Po zatrzymaniu wirnika wykonać MAINS RESET.
LID ERROR (BŁĄD POKRYWY)	4.1 – 4.127	Błąd blokady pokrywy lub zamknięcia pokrywy.	
OVER SPEED (NADMIERNA PRĘDKOŚĆ)	5	Rotacja jest zbyt szybka	
VERSION ERROR (BŁĄD WERSJI)	12	Rozpoznano nieprawidłowy model wirówki. Błąd / uszkodzenie elektroniki	
UNDER SPEED (NIEDOSTATECZNA PRĘDKOŚĆ)	13	Rotacja jest zbyt wolna	<ul style="list-style-type: none"> – Po zatrzymaniu wirnika wykonać MAINS RESET.
CTRL ERROR (BŁĄD STEROWANIA)	22.1, 25.2	Błąd / uszkodzenie elektroniki	
CRC ERROR (BŁĄD CRC)	27.1		
COM ERROR (BŁĄD COM)	31 – 36		
FC ERROR (BŁĄD FC)	60, 61.1 – 61.21, 61.64 – 61.142		
	61.23		
FC ERROR (BŁĄD FC)	61.23		<ul style="list-style-type: none"> – Urządzenia nie wolno wyłączać, dopóki wskaźnik obrotów  świeci się i obraca. Poczekać, aż wyświetli się symbol  (pokrywa zablokowana) (po około 120 sekundach). Następnie wykonać MAINS RESET.
TACHO ERR (BŁĄD TACHOGRAFU)	61.22	Błąd pomiaru prędkości	
FC ERROR (BŁĄD FC)	61.153	Błąd / uszkodzenie elektroniki	<ul style="list-style-type: none"> – Wykonać MAINS RESET. – Sprawdź obciążenie wirnika zgodnie z dostarczoną instrukcją. – Powtórzyć cykl wirowania.

15 WZGLĘDNA SIŁA ODŚRODKOWA (RCF)

Względna siła odśrodkowa jest podawana jako wielokrotność przyspieszenia ziemskiego (g). Jest ona wartością liczbową i służy do porównania wydajności oddzielania i sedymentacji. Względna siła odśrodkowa (RCF) jest zależna od prędkości obrotowej i promienia wirowania. Można to obliczyć za pomocą poniższego wzoru:

$$RCF = \left(\frac{RPM}{1000} \right)^2 \times r \times 1,118 \quad \Rightarrow \quad RPM = \sqrt{\frac{RCF}{r \times 1,118}} \times 1000$$

RCF = względna siła odśrodkowa

RPM = prędkość obrotowa (obroty na minutę)

r = promień wirowania w mm = odległość od środka osi obrotu do dna wirującego pojemnika.

16 TRANSPORT I PRZECHOWYWANIE

Przed transportem urządzenia należy zamontować zabezpieczenie transportowe. Urządzenie i akcesoria wolno przechowywać wyłącznie w zamkniętych i suchych pomieszczeniach. Podczas transportu lub przechowywania urządzenia i akcesoriów należy spełnić następujące warunki:

Temperatura otoczenia: od -20°C do +60°C.

Wilgotność względna: od 10% do 80%, bez kondensacji.

17 WYMIENIĆ BEZPIECZNIKI WEJŚCIOWE SIECI

Zacznij od wyłączenia przełącznika zasilania i odłączenia urządzenia od sieci. Uchwyt bezpiecznika (A) wraz z bezpiecznikami wejściowymi sieci znajduje się obok włącznika sieciowego. Wyjąć kabel połączeniowy z gniazda wtykowego urządzenia. Wcisnąć zamknięcie zaciskowe (B) w uchwyt bezpiecznika (A) i wyciągnąć go. Wymienić uszkodzone bezpieczniki wejściowe sieci. Używać wyłącznie bezpieczników o wartości znamionowej określonej dla typu wirówki podanej przez producenta. Ponownie wsunąć uchwyt bezpiecznika do momentu zaskoczenia zamknięcia zaciskowego. Ponownie podłączyć urządzenie do sieci zasilania.

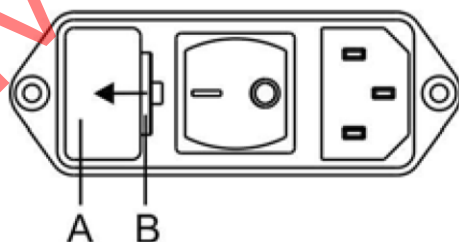

18 ZWROT URZĄDZEŃ

Przed zwrotem urządzenia trzeba zamontować zabezpieczenie transportowe. Jeśli urządzenie lub jego akcesoria zostaną zwrócone do legalnego producenta, w celu zapewnienia ochrony ludzi, środowisku i materiałom, należy je odkazić i wyczyścić przed wysyłką. Prawny producent zastrzega sobie prawo do odmowy przyjęcia zanieczyszczonych urządzeń lub akcesoriów. Kosztami ewentualnego czyszczenia i dezynfekcji zostanie obciążony klient.

19 UTYLIZACJA

Przed utylizacją urządzenia konieczna jest jego dekontaminacja i oczyszczenie w celu ochrony osób, środowiska i mienia. W przypadku utylizacji urządzenia należy przestrzegać obowiązujących przepisów. Stosownie do dyrektywy 2002/96/WE (WEEE) urządzeń dostarczonych po 13 sierpnia 2005 r. nie można wyrzucać jako odpadów domowych. Urządzenie należy do grupy 8 (sprzęt medyczny) i jest zaszeregowane do obszaru „business to business”. Symbol z przekreślonym koszem wskazuje na zakaz wyrzucania urządzenia wraz z odpadami domowymi. Przepisy poszczególnych krajów UE w zakresie utylizacji odpadów mogą się od siebie różnić. W razie potrzeby należy skontaktować się z dostawcą.

ARCHIVED DOCUMENT



Následující tabulka představuje pouze orientační přehled s významem symbolů. Konkrétní údaje s příslušnými symboly naleznete na výrobku nebo obalu výrobku.

Symbol	Význam symbolu
	Upozornění
	Návod k obsluze elektroniky
	Výrobce
	Výrobky BioHorizons mají označení CE a splňují požadavky směrnice 93/42/EHS o zdravotnických prostředcích.
	Referenční číslo / číslo výrobku
	Číslo šarže
	Nepoužívejte opakovaně
	Nesterilizujte opakovaně.
	Datum spotřeby
	Sterilizováno gama zářením
	Datum výroby
	Pozor: Dle federálních zákonů USA smí být tento výrobek prodáván, distribuován a používán výhradně zubaři či lékaři nebo na jejich předpis.

Symbol	Význam symbolu
	Výchozí pozice
	Nepoužívejte, je-li obal poškozen
	Zdravotnický prostředek
	Nesterilní
	Uchovávejte v suchu
	Křehké, manipulujte opatrně
	Teplotní rozmezí
	Tímto směrem nahoru
	Rozmezí vlhkosti
	Varování, biologické riziko
	Důležité informace
	Oddělený sběr elektroodpadu a elektrozařízení.
	Zplnomocněný zástupce v Evropském společenství

1 INDIKOVANÉ POUŽITÍ

Systém IntraSpin je určen k bezpečné a rychlé přípravě autologního fibrinu bohatého na leukocyty a trombocyty (L-PRF) z malého vzorku krve pacienta okamžitě po odběru ve zdravotnickém zařízení. L-PRF se před aplikací do kostního defektu smíchá s autologním či alogenním kostním štěpem, aby se s materiálem lépe manipulovalo. Součástí indikovaného použití je dodržení všech pokynů v návodu.

2 KONTRAINDIKACE

Centrifuga IntraSpin je určena výhradně k výše uvedenému indikovanému použití. Jakékoli jiné použití přístroje spadá mimo účel použití. Použití centrifugy IntraSpin je kontraindikováno v případě některé z následujících klinických situací či jejich kombinace: Pacient se závislostí na alkoholu či s duševním onemocněním, krevní dyskrázie, neléčená cukrovka, hypertyreóza, infekce v dutině ústní, zhoubný nádor či pacient, který v uplynulých 12 měsících prodělal infarkt myokardu. Pacient se systémovým onemocněním, které narušuje fungování imunitního systému, např. AIDS, pacient s medikací, která narušuje proces hojení v místě implantace, pacient se špatnou ústní hygienou či pacient, který soustavně nedodržuje pokyny pro správnou ústní hygienu.

Pacienti, kteří podstupují antikoagulační léčbu. U těchto pacientů se nevylučuje použití PRF, pro úspěšnou separaci je však třeba odstřeďovat krev v centrifuze déle.



3 BEZPEČNOSTNÍ POKYNY

- Nárok na záruku ze strany výrobce má uživatel pouze v případě, že bude dodržovat VEŠKERÉ pokyny v tomto návodu.
- Návod k použití je součástí přístroje. Musí být neustále dostupný v blízkosti přístroje. Bude-li přístroj přemístěn, musí být návod k dispozici i v novém umístění.
- Centrifuga musí být umístěna na pevném, stabilním podkladu.
- Před použitím centrifugy je třeba zkontrolovat, zda je rotor ve stabilní pozici.
- V průběhu odstřeďování nesmí být v okolí centrifugy v minimální bezpečné vzdálenosti do 300 mm přítomny žádné osoby, nebezpečné látky ani předměty.
- Objeví-li se na rotoru, závěsu či jiném příslušenství známky koroze či mechanického poškození nebo uplyne-li doba jejich použitelnosti, nesmí se nadále používat.
- Vykazuje-li odstřeďovací komora poškození, které by mohlo ohrozit bezpečnost, nesmí se centrifuga nadále používat.
- U centrifug bez regulace teploty se může v případě zvýšení teploty okolního prostředí a/nebo častého používání stát, že se bude odstřeďovací komora zahřívat. Není proto vyloučeno, že se vlivem vyšší teploty mohou vlastnosti vzorku změnit.
- Před prvním použitím centrifugy si pozorně přečtěte návod k použití. Přístroj mohou obsluhovat pouze osoby, které se důkladně seznámily s veškerými pokyny a porozuměly jim.
- Spolu s pokyny v návodu a právními předpisy o prevenci úrazů je třeba rovněž dodržovat uznávané profesní normy v oblasti bezpečného a odborného zacházení s přístrojem. Kromě tohoto návodu je třeba se seznámit s veškerými dalšími pravidly prevence úrazů a ochrany životního prostředí, která vycházejí z národní legislativy státu, v němž se přístroj používá.
- Dodržování specifických požadavků země týkajících se bezpečnosti uživatele při práci, která je spojená s používáním centrifug na pracovišti, poskytovaných k danému účelu, je odpovědností uživatele.

- Tato centrifuga představuje vysoce moderní vybavení, jehož provoz je mimořádně bezpečný. Pokud ji však nebude obsluhovat řádně vyškolený personál, nebude používána dle pokynů nebo bude používána k jinému účelu, než k jakému je určena, může to ohrozit bezpečnost uživatelů či dalších osob.
- Během odstředování se centrifuga nesmí přemísťovat ani nijak posouvat.
- V případě poruchy či nouzového uvolnění se nikdy nedotýkejte rotoru, dokud se nepřestane otáčet.
- Aby se zabránilo poškození v důsledku kondenzace při přemístění z chladnější do teplejší místnosti, musí se centrifuga v teplé místnosti nejprve alespoň 3 hodiny ohřívat, než se zapojí do sítě, nebo musí být v chladné místnosti alespoň 30 minut spuštěna, aby se vyhřála.
- Při odstředování při maximálních otáčkách za minutu může být hustota materiálů nebo směsi materiálů maximálně 1,2 kg/dm³.
- Centrifugu lze spustit pouze v případě, že je rovnoměrně vyvážená s odchylkou v povoleném rozmezí.
- Centrifuga se nesmí používat v prostorách s nebezpečím exploze.
- Centrifuga se nesmí používat s hořlavými či výbušnými materiály ani materiály, u nichž při vzájemné reakci vzniká hodně energie.
- Pro tuto centrifugu nejsou k dispozici žádné systémy biologické bezpečnosti.
- V centrifuze se nesmí používat vysoce žíravé látky, které by mohly narušit mechanickou integritu rotorů, závěsů a dalšího příslušenství.
- Opravy na přístroji smí vykonávat pouze kvalifikovaný servisní pracovník schválený výrobcem.
- Produkty IntraSpin se vyrábějí z materiálů, které jsou kompatibilní s lidskou plazmou, a mohou tak pacientům nabídnout nejvyšší úroveň klinické bezpečnosti.
- Tento výrobek není schválen k prodeji na všech trzích a nemusí být k dispozici ve vašem státě. Pro více informací se obraťte na svého dodavatele.

4 KOMPONENTY SYSTÉMU INTRASPIN

KOMPONENT	POČET KUSŮ NA SYSTÉM
Centrifuga IntraSpin včetně:	1
síťového kabelu	1
pojistek	2
imbusového klíče	1
Odběrové zkumavky a balanční zkumavky (jednorázové) společnosti Greiner.	150
Souprava na bezpečný odběr krve Greiner + držák, 21G (jednorázová)	24
Zdravotnické zaškrvadlo bez latexu	1
Stojan na zkumavky	1
Chirurgické zahnuté nůžky	1
Chirurgické tkáňové kleště	1
Kulatá nerezová miska	1
Hranatá nerezová miska	1
Špachtle na duální biomateriál	1
Cpátka na duální biomateriál	1
Kompresní box Xpression®	1

S centrifugou IntraSpin doporučujeme používat pouze komponenty, u nichž byla ověřena kompatibilita pro přímé použití se systémem, a pouze na ně se vztahuje záruka:

KOMPATIBILNÍ DÍL #	POPIS
455092	9ml CAT zkumavky, aktivátor srážení pro separaci séra, červený uzávěr
455001	Bílé víčko, 9 ml Ze zkumavky bez přísad
BHEXZ (E613)	Imbusový klíč IntraSpin, 110 V & 220 V
BROTORZ (E3694)	Rotor IntraSpin, 100 V & 220 V
BPOWER110Z (E1673)	Síťový kabel IntraSpin, 110 V
BPOWER220Z (E1669)	Síťový kabel IntraSpin, 220 V
BTUBEHOLDZ (E872 x 1)	Náhradní držák na zkumavky IntraSpin
BFUSE110Z (E997)	Pojistka IntraSpin 110v
BFUSE220Z (E891)	Pojistka IntraSpin 220v

5 RYCHLÁ INSTALACE CENTRIFUGY

Odšroubujte transportní šrouby ze dna centrifugy a uschovejte si je.

Připojte k přístroji AC kabel a zapojte ho do elektrické sítě.

Zapněte centrifugu pomocí kolébkového spínače vzadu na přístroji.

Zadejte rychlost a délku cyklu: rychlost = 2700 & čas = 12:00 min.

Stiskněte START.

Po ukončení každého cyklu se víko centrifugy automaticky otevře.

Po prvním použití se zadaná rychlost a délka cyklu uloží do paměti centrifugy a zůstanou v ní uloženy, dokud hodnoty nezměníte v nastavení.

6 UPOZORNĚNÍ A INSTRUKCE K ODBĚROVÝM ZKUMAVKÁM A ODBĚROVÝM SADÁM

- Nepoužívejte zkumavky, nachází-li se v nich cizí těleso.
- Odběrová zkumavka musí být zcela naplněna.
- Nakládejte se všemi biologickými vzorky a „ostrými součástkami“ odběru krve (např. jehly a odběrové sady) podle zásad a postupů vašeho zdravotního zařízení.
- Neohýbejte jehlu.
- Po aktivaci bezpečnostního mechanismu jehly jej již násilím neodemykejte ani se nesnažte znovu aktivovat.
- V případě vystavení účinkům biologických vzorků (např. při poranění vpichem) je třeba poskytnout náležitou lékařskou péči, a to z důvodu možného přenosu HIV (AIDS), virální hepatitidy či jiných infekčních onemocnění.
- Veškeré „ostré nástroje“ na odběr krve vyhodte do sběrné nádoby vyčleněné na biologický a infekční odpad.
- Přenos vzorku stříkačkou do zkumavky není doporučený postup.
- Odebíráte-li krev pomocí intravenózního (IV) katétru, postupujte v souladu s pravidly a standardními postupy vašeho pracoviště, aby se ještě před začátkem plnění odběrových zkumavek zajistilo, že v katétru nezůstal žádný intravenózní roztok.
- Urychlovač srážení krve může způsobovat zblednutí povrchu zkumavky, to však nemá žádný vliv na funkci zkumavek. Objeví-li se ve zkumavce jakékoli jiné diskolorace či sráženiny, nepoužívejte ji.
- Nepoužívejte zkumavky po vypršení data spotřeby.
- Skladujte odběrové zkumavky při teplotě 4–25 °C (40–77 °F).

- Skladujte odběrové sady (jehlu a držák) při teplotě 4–36 °C (40–97 °F).
- Nevystavujte slunečnímu záření. Je-li zkumavka uchovávána při vyšší než maximální doporučené teplotě, může to narušit její kvalitu (např. ztráta vakua, zabarvení apod.)
- Aby se zamezilo zpětnému toku, musí paže pacienta volně viset, zkumavku držte uzávěrem nahoru a jakmile začne do zkumavky téct krev, povolte zaškrcovadlo. Zabraňte tomu, aby se obsah zkumavky dostal do kontaktu s uzávěrem nebo koncem jehly při vpichu do žíly.
- Před vpichem do žíly se ujistěte, že máte po ruce všechny následující materiál a pomůcky: všechny potřebné zkumavky na odběr krve, identifikační štítky pro označení vzorků pacienta, jehlu na odběr krve a držáky, tampon s alkoholem pro dezinfekci místa vpichu, čistou gázu, zaškrcovadlo, náplast či obvaz, nádobu určenou na biologický a infekční odpad. Jako ochranu před nákazou patogeny přenášenými krví doporučujeme použít vhodné OOP (osobní ochranné prostředky) – např. rukavice, laboratorní plášť, ochranné brýle apod.

Technika venepunkce a odběr vzorku krve:

Odběr krve musí být proveden co nejrychleji, protože v odběrových zkumavkách není žádný koagulant. Vzorek krve se začne okamžitě srážet. Během vpichu do žíly a při manipulaci s odběrovými zkumavkami mějte nasazené ochranné rukavice, aby se minimalizovalo riziko přenosu nákazy. Před natažením krve do zkumavky otřete vršek uzávěru zkumavky dezinfekčním ubrouskem dle vlastního výběru. Sejměte kryt z bezpečnostního ventilu jehly. Místo vpichu vydezinfikujte vhodným antiseptikem. Po očištění se už místa vpichu nedotýkejte. Nechte paži pacienta volně viset. Sejměte kryt z jehly. Proveďte venepunkci do svěšené paže, uzávěr zkumavky musí být co nejvýše. Je-li to zapotřebí, zajistěte jehlu pomocí pásky. Vložte odběrovou zkumavku do držáku a zatlačte na bezpečnostní ventil, aby jehla propíchnula gumovou membránu odběrové zkumavky. Při penetraci uzávěru vyrovnejte odběrové zkumavky v držáku, aby nedošlo k boční penetraci a v důsledku toho k předčasné ztrátě vakua. Jakmile se v odběrové zkumavce objeví krev, uvolněte zaškrcovadlo. Během odběru vždy držte odběrovou zkumavku na místě palcem, aby byla krev natahována pomocí vakua. Odběrová zkumavka se automaticky naplní. Pokud do odběrové zkumavky neteče žádná krev nebo krev přestane téct dříve, než odeberete potřebný vzorek, doporučujeme pro úspěšný odběr postupovat následovně:

- Zatlačte na odběrovou zkumavku směrem dopředu, abyste se ujistili, že je gumový uzávěr propíchnutý.
- Ujistěte se, že je jehla v žíle zavedena správně.
- Pokud ani v tuto chvíli krev neteče, odstraňte odběrovou zkumavku a řádně ji zlikvidujte. Vezměte si novou odběrovou zkumavku a zasuňte ji do držáku.
- Pokud se ani do druhé odběrové zkumavky nenatahuje krev, vyjměte jehlu i zkumavku a řádně je zlikvidujte. Opakujte celý postup.
- Až se odběrová zkumavka naplní krví po označené maximum, opatrně ji vyndejte z držáku. Opakujte postup s druhou odběrovou zkumavkou.

Ihned po vyjmutí z držáku promíchejte obsah každé odběrové zkumavky obracením. Netřepejte zkumavkami s odebraným vzorkem krve. Přílišné míchání může způsobit pění či hemolýzu. Nedostatečné či opožděné promíchání zkumavky se sérem může mít za následek opožděné srážení.

Po dokončení odběru krevního vzorku vyjměte jehlu z žíly. Aktivujte bezpečnostní mechanismus (bezpečnostní štít) jehly stisknutím obou stran nástavce k zajištění zámku. Posunujte bezpečnostní

mechanismus nazpět, dokud nedojde ke slyšitelnému zacvaknutí. Nenasazujte kryt zpět na jehlu, zvýšili byste tím riziko poranění jehlou a vystavení krve. Použitou jehlu společně s držákem vyhodte do vhodné nádoby na biologický a kontaminovaný zdravotní materiál. Přitlačte na místo vpichu suchý sterilní tampon a držte jej na místě, dokud se krvácení nezastaví. Až se objeví srážení, je možné místo vpichu převázat i obvazem. Zkumavky s odebranou krví doporučujeme uchovávat uzávěrem vzhůru. Po naplnění druhé odběrové zkumavky vyjměte zkumavku z držáku a umístěte obě zkumavky do centrifugy do protilehlých pólů, aby byl rotor vyvážen. Uzavřete víko centrifugy IntraSpin a stiskněte tlačítko START, poté bude 12 minut probíhat odstředování.

Je-li zapotřebí více než dvou zkumavek, postupujte podle tohoto alternativního postupu: Po odebrání a jemném převrácení prvních dvou zkumavek je ihned umístěte do centrifugy IntraSpin do protilehlých pozic, abyste zajistili její správné vyvážení. Uzavřete víko a stiskněte tlačítko START. Nechte centrifugu spuštěnou a mezitím odeberte krev do zbývajících zkumavek. Poté stiskněte tlačítko STOP a vyčkejte, než se centrifuga zcela zastaví. Víko se automaticky otevře. Okamžitě do centrifugy vložte zbývajících zkumavky, opět do protilehlých pozic, aby byla centrifuga vyvážená. Stiskněte tlačítko START, cyklus se spustí opět od začátku a bude dokončen postup dle doporučeného protokolu.

Zkumavky vkládejte do centrifugy vždy po dvou a vždy do protilehlých pozic, aby byl rotor centrifugy vyvážen. Než stisknete tlačítko START, musí být zkumavky v rotoru vždy rovnoměrně vyvážené, jinak by se mohla centrifuga poškodit nebo by srážení a/nebo separace neproběhly správně. Pokud by zkumavky nebyly řádně vyvážené, bude centrifuga během odstředování příliš vibrovat a v důsledku toho se nevytvoří kvalitní fibrinová sraženina L-PRF.

Máte-li lichý počet krevních vzorků, umístěte do centrifugy také balanční zkumavku (např. 455001) naplněnou vodou do protilehlé pozice k nepárové zkumavce v rotoru. Tímto zajistíte správné vyvážení centrifugy.

Centrifugu spusťte ihned po odebrání krve. Pozdější spuštění má neblahý vliv na proces separace krve a výsledkem by byla nekvalitní fibrinová sraženina L-PRF.

7 PŘÍPRAVA L-PRF

Po dokončení odstředovacího cyklu je krev rozdělena na tři viditelné segmenty.

1. Horní segment = plazma chudá na krevní destičky (PPP).
2. Prostřední segment = fibrinová sraženina: L-PRF.
3. Dolní segment = sraženina červených krvinek.

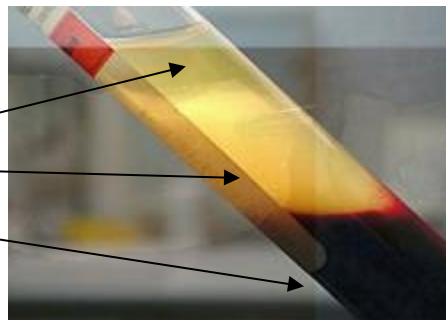

Membrána či zátka z fibrinu L-PRF se musí připravit relativně rychle: 0–15 minut po dokončení centrifugace, jinak se sraženina scvrkne, protože se z ní uvolní uchycené sérum. Po dokončení centrifugace sejměte z každé zkumavky gumový uzávěr. Pomocí chirurgických tkáňových nůžek vyjměte ze zkumavky sraženinu L-PRF. Opatrně z fibrinové sraženiny L-PRF® seškrábejte sraženinu červených krvinek těsně pod jejich spojením, k tomu použijte špachtli na duální biomateriál. Na sraženině L-PRF musí zůstat jen minimální zbytek červených krvinek. Položte fibrinovou sraženinu na perforovaný tácek v boxu Xpression.

8 PŘÍPRAVA FIBRINOVÉHO MATRIXU

Protokol č. 1 – Membrána L-PRF

Položte všechny fibrinové sraženiny na perforovaný tácek v boxu Xpression. Poté na fibrinové sraženiny položte kompresní destičku Xpression a přiklopte tácek zatíženým víkem Xpression, na sraženiny nijak netlačte.

Zatížené víko bude fibrinovou sraženinu pomalu stlačovat, na dno tácku pak bude vytékat vyloučený filtrát. Na zatížené víko nijak netlačte. Zatížené víko bude působením gravitační síly sraženinu jemně lisovat samo a vytlačí tím ze sraženiny L-PRF sérum, aniž by byla narušena fibrinová síť.

Vyčkejte alespoň 5 minut, až poté můžete vyjmout a použít fibrinovou membránu. Nevynádejte fibrinovou membránu z boxu, dokud nebudete připraveni ji použít. Fibrinová membrána může zůstat v boxu Xpression až 3 hodiny.

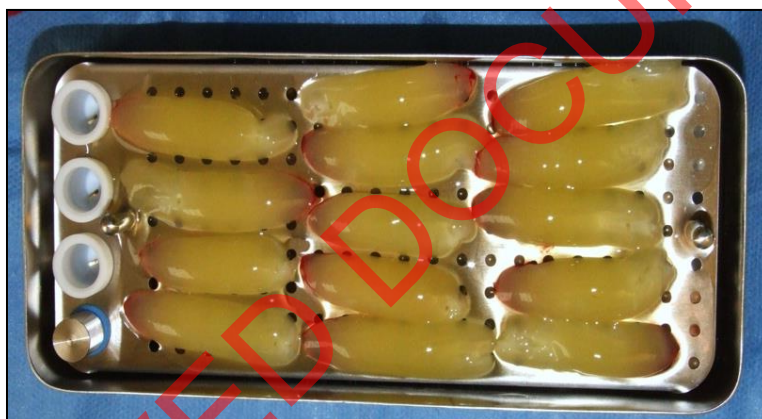

Protokol č. 2 – Zátka L-PRF

Vložte fibrinovou sraženinu do bílého válečku na výrobu zátek. Pomocí pístu sraženinu v bílém válečku na výrobu zátek L-PRF pomalu stlačujte. Pokračujte ve stlačování, dokud nebude horní okraj pístu v rovině s horním okrajem bílého válečku na výrobu zátek L-PRF. Pomocí této techniky lze vyrobit silnou kulatou fibrinovou zátka do extrakčního lůžka. U zubů s jednoduchým hrotem by měla postačit jedna zátka L-PRF. U premolárů mohou být potřeba 2 zátky L-PRF a u molárů tři zátky L-PRF, záleží vždy na velikosti extrakčního lůžka a velikosti vytvořené fibrinové sraženiny.

Díky svým vlastnostem představuje L-PRF výborné médium při použití v kombinaci s biomateriálem dle vašeho výběru. Postupujte dle kteréhokoli z následujících míchacích protokolů. Biomateriál se zachytí do fibrinového matrixu a tím se zlepší jeho biologické a manipulační vlastnosti.

Protokol č. 3 – Směs biomateriálu/L-PRF

Pro vytvoření směsi tmelovité konzistence, kterou lze pomocí nástroje na biomateriál snadno zformovat do požadovaného tvaru a tloušťky, postupujte dle následujícího protokolu: Pomocí chirurgických

zahnutých nůžek fibrinovou membránu L-PRF ve sterilní misce opatrně nastříhejte na malé kousky. Přidejte požadované množství materiálu pro náhradu kosti. L-PRF s kostním materiálem důkladně promíchejte. Vzniklou směs můžete vložit do defektu pomocí špachtle na duální biomateriál.



Protokol č. 4 – Směs matrixu biomateriálu/L-PRF

Do sterilní misky nebo na sterilní tácek umístěte požadované množství materiálu pro náhradu kosti. Ponořte do kostního materiálu vylisovanou membránu/membrány L-PRF nebo kousky membrány L-PRF tak, aby byl celý povrch membrány L-PRF zakrytý kostním materiálem. Jako alternativní postup lze celý povrch membrány L-PRF posypat kostním materiálem. Upozornění: Vlhčejší membrána L-PRF zadrží o něco více kostního materiálu než sušší membrána L-PRF. Kostní materiál by měl přilnout k povrchu L-PRF, pokud však chcete, je možné kostní materiál na membránu L-PRF i lehce přitlačit. Pro vložení směsi do defektu můžete použít chirurgické tkáňové kleště.



Protokol č. 5 – Hydratace biomateriálu

Do sterilní misky nebo na sterilní tácek umístěte požadované množství materiálu pro náhradu kosti. Kostní materiál hydratujte pomocí vytlačeného filtrátu ze dna tácku boxu Xpression. Kostní materiál s filtrátem důkladně promíchejte. Vzniklou směs můžete vložit do defektu pomocí špachtle na duální biomateriál.



9 ČIŠTĚNÍ A STERILIZACE SOUPRAVY NA REGENERACI TKÁNĚ

V boxu Xpression lze snadno připravit fibrinové membrány o jednotné tloušťce. Vyloučený filtrát se shromáždí na dně sběrného tácku Xpression pod perforovaným táckem Xpression. Součástí boxu Xpression jsou válečky na výrobu zátek L-PRF a píst na výrobu zátek L-PRF, které dobře pasují do lůžka po extrakci zubu.



Zatížené víko Xpression



Kompresní destička Xpression



Perforovaný tácek Xpression ve sběrném tácku Xpression

Box Xpression a jeho příslušenství se dodávají NEsterilní. Před úvodní sterilizací vyjměte veškerý obalový materiál a vyhoďte ho. Box Xpression a jeho příslušenství čistěte a sterilizujte před každým použitím.

Před každým čistícím a sterilizačním cyklem box Xpression rozeberte na jednotlivé části, aby v něm nezůstaly žádné zbytky tkáně, nedocházelo k diskoloraci materiálu a/nebo nedokonalému vysušení komponentů. Válečky na výrobu zátek L-PRF a obruba v otvoru na píst mohou při čištění a sterilizaci zůstat v perforovaném tácku Xpression.

Čištění: (1) Pomocí kartáčku s měkkými štětkami a širokospektrálního čistícího či dezinfekčního činidla (např. Enzymax® od Hu-Friedy či ekvivalentního činidla) odstraňte z jednotlivých komponentů boxu Xpression a jeho příslušenství veškerou viditelnou zbytkovou tkáň. Důkladně opláchněte. (2) Umístěte komponenty boxu Xpression a jeho příslušenství do nádoby vhodné velikosti se stejným roztokem a čistěte 10 minut v ultrazvukové čističce. Důkladně opláchněte. (3) Opláchněte komponenty boxu Xpression a jeho příslušenství v izopropyl alkoholu, aby se odstranily veškeré zbytky čistícího prostředku a minerálů. (4) Osušte komponenty boxu Xpression a jeho příslušenství nežmolujícím hadříkem a nechte zcela vyschnout na vzduchu. Postupujte dle pokynů na obalu čistícího činidla.

Sterilizace: (1) Vložte složený box Xpression a jeho příslušenství do sterilizačního sáčku nebo sterilizační fólie schválených úřadem FDA. (2) Spusťte jeden z následujících validovaných sterilizačních cyklů:

Metoda sterilizace	Teplota	Doba působení	Minimální doba sušení
Prevakuová sterilizace párou (ANSI/AAMI ST79)	132 °C (270 °F)	4 minuty	20–30 minut
Prevakuová sterilizace párou (UK DoH Health Technical Memorandum 01-01)	134 °C (273 °F)	3 minuty	20–30 minut

Pozor! Nebyl-li produkt důkladně vyčištěn, může se stát, že sterilizace neproběhne správně. V případě nedostatečného vysušení komponentů boxu Xpression a jeho příslušenství může na zavlhých místech dojít v průběhu sterilizace v autoklávu k diskoloracím a oxidaci materiálu. Působením peroxidu vodíku či jiných oxidačních činidel se ničí povrch komponentů boxu Xpression a jeho příslušenství. Doporučujeme vybavení autoklávu pravidelně testovat, čistit a kalibrovat, aby bylo zařízení stále v dobrém funkčním stavu.

10 ČIŠTĚNÍ A ÚDRŽBA CENTRIFUGY

Přístroj může být kontaminován. Před čištěním odpojte přístroj ze sítě. Centrifugy, rotory ani příslušenství se nesmí čistit v mycím přístroji. Lze je čistit pouze ručně a dezinfikovat tekutými prostředky. Voda musí mít teplotu 20–25 °C. Používejte pouze čisticí a dezinfekční činidla s pH 5–8, která neobsahují žíravé zásady, peroxidy, sloučeniny chloru, kyseliny ani zásadité roztoky. Dodržujte veškeré pokyny výrobce čisticích a dezinfekčních prostředků, aby se na přístroji a příslušenství neobjevily v důsledku čištění a dezinfekce známky koroze.

Pravidelně čistěte vnější kryt centrifugy i odstředivací komoru, použijte mýdlo či jiný šetrný čisticí prostředek a případně navlhčený hadřík, aby se předešlo korozi vlivem usazených nečistot. Mezi povolené složky vhodných čisticích prostředků patří mýdlo, aniontové tenzidy a neiontové tenzidy. Po použití čisticího prostředku odstraňte veškeré zbytky mycího činidla pomocí navlhčeného hadříku. Povrchy se musí okamžitě po omytí osušit. Pokud dojde ke kondenzaci vody, vytřete odstředivací komoru do sucha pomocí svého hadříku. Gumové těsnění odstředivací komory po každém čištění lehce zasypte tělovým pudrem nebo potřete prostředkem na ošetření gumy. Pravidelně kontrolujte, zda není odstředivací komora nijak poškozena. Zjistíte-li závadu, která by mohla ohrozit bezpečnost, nesmí se centrifuga nadále používat. V takovém případě se obraťte na zákaznickou podporu.

Pronikne-li do odstředivací komory infekční materiál, je třeba ji ihned vydezinfikovat. Mezi povolené složky vhodných dezinfekčních prostředků patří etanol, n-propanol, ethyl-hexanol, aniontové tenzidy a inhibitory koroze. Po použití dezinfekčního prostředku odstraňte veškeré zbytky dezinfekčního činidla pomocí navlhčeného hadříku. Povrchy se musí okamžitě po vydezinfikování osušit.

Pro odstranění radioaktivních kontaminantů použijte činidlo, které je speciálně označeno jako prostředek na odstraňování radioaktivních kontaminantů. Mezi povolené složky vhodných prostředků na odstraňování radioaktivních kontaminantů patří aniontové tenzidy, neiontové tenzidy a polyhydratovaný etanol. Po odstranění radioaktivních kontaminantů otřete veškeré zbytky činidla pomocí navlhčeného hadříku. Povrchy se musí okamžitě po odstranění radioaktivních kontaminantů osušit.

11 ČIŠTĚNÍ A ÚDRŽBA ROTORU A PŘÍSLUŠENSTVÍ

Aby se zamezilo korozi a změnám na materiálu, musí se rotor a příslušenství pravidelně čistit mýdlem či jiným šetrným čisticím prostředkem a pomocí navlhčeného hadříku. Doporučujeme zařízení čistit alespoň jednou týdně. Kontaminanty je třeba odstranit okamžitě.

Mezi povolené složky vhodných čisticích prostředků patří mýdlo, aniontové tenzidy a neiontové tenzidy. Po použití čisticího prostředku opláchněte veškeré zbytky mycího činidla vodou (pouze vnější část centrifugy) nebo je otřete navlhčeným hadříkem. Rotor i příslušenství se musí okamžitě po vyčištění osušit. Každý týden kontrolujte, zda nejeví rotor či příslušenství známky opotřebení nebo koroze. Pokud se na rotoru či příslušenství objeví známky koroze nebo opotřebení, nesmí se nadále používat. Rovněž pravidelně každý týden kontrolujte, zda je rotor v přístroji pevně usazen. Dostane-li se do rotoru či příslušenství infekční materiál, je třeba vše důkladně vydezinfikovat.

Mezi povolené složky vhodných dezinfekčních prostředků patří etanol, n-propanol, ethyl-hexanol, aniontové tenzidy a inhibitory koroze. Po použití dezinfekčního prostředku opláchněte veškeré zbytky dezinfekčního činidla vodou (pouze vnější část centrifugy) nebo je otřete navlhčeným hadříkem. Rotor i příslušenství se musí okamžitě po vydezinfikování osušit.

Pro odstranění radioaktivních kontaminantů použijte činidlo, které je speciálně označeno jako prostředek na odstraňování radioaktivních kontaminantů. Mezi povolené složky vhodných prostředků na odstraňování radioaktivních kontaminantů patří aniontové tenzidy, neiontové tenzidy a polyhydratovaný etanol. Po odstranění radioaktivních kontaminantů opláchněte veškeré zbytky činidla vodou (pouze vnější část centrifugy) nebo je otřete navlhčeným hadříkem. Rotor i příslušenství se musí okamžitě po odstranění radioaktivních kontaminantů osušit.

Rotor lze sterilizovat v autoklávu při teplotě 121 °C (250 °F) po dobu 20 minut, musí být důkladně vysušen. Po 10 cyklech v autoklávu se musí rotor z bezpečnostních důvodů vyměnit. Proces sterilizace v autoklávu urychluje opotřebení plastových dílů a může způsobovat diskolorace. Po sterilizaci v autoklávu musí rotor před opětovným použitím vychladnout na pokojovou teplotu. Nelze oficiálně stanovit úroveň sterility.

Doba používání rotoru je omezena na 50 000 cyklů (odstředovacích cyklů v centrifuze) nebo 5 let, podle toho, co nastane dříve. Maximální povolený počet cyklů je uveden na rotoru. Z bezpečnostních důvodů rotor po dosažení maximálního povoleného počtu cyklů (uvedeno na rotoru) dále nepoužívejte. Přístroj je vybaven počítadlem cyklů, které sčítá počet provedených cyklů (odstředovacích cyklů v centrifuze).

V případě rozbití zkumavky na krev všechny kusy zkumavky i krev odstraňte. Centrifuga se musí důkladně vyčistit dle pokynů, gumové vložky a plastové objímky rotoru se musí vyměnit.

12 TECHNICKÉ PARAMETRY CENTRIFUGY

Typ modelu	IS 220Z	IS 110Z
Síťové napětí ($\pm 10\%$)	200–240 V 1~	100–127 V 1~
Frekvence	50–60 Hz-	50–60 Hz
Zatížení po připojení	100 VA	100 VA
Spotřebováváný proud	0,5 A	1,0 A
Kapacita	8 x 10 ml	
Maximální povolená hustota	1,2 kg/dm ³	
Maximální otáčky (ot./min.)	6000	
Relativní centrifugační síla (RCF)	3461	
Kinetická energie	750 Nm	
Místo instalace	Pouze v interiéru	
Nadmožská výška	Až 2000 m n. m.	
Teplota okolního prostředí při provozu	5–40 °C	
Relativní vlhkost při provozu	Maximální relativní vlhkost 80 % při teplotě do 31 °C, lineárně se snižuje na relativní vlhkost 50 % při teplotě 40 °C.	
Kategorie přepětí	II	
Stupeň znečištění	2	
Třída ochrany zařízení	I	
	Není vhodné k použití v prostoru s rizikem výbuchu.	
Vysílání rušivých interferencí, imunita vůči rušení	EN / IEC 61326-1, třída B	FCC třída B
Úroveň hluku (závisí na rotoru)	≤ 50 dB(A)	
Šířka centrifugy	261 mm	
Hloubka centrifugy	353 mm	
Výška centrifugy	228 mm	
Hmotnost centrifugy	cca 9 kg	

13 POKYNY K POUŽITÍ CENTRIFUGY

Před použitím je nezbytné odstranit prvky zajišťující bezpečnost při přepravě – 2 šrouby (a) a 2 distanční (b) podložky. Zajišťovací transportní prvky uschovejte na bezpečném místě, před dalším transportem je totiž třeba je opět nainstalovat. Výrobek lze přepravovat pouze s nainstalovanými zajišťovacími prvky. Motor je pomocí šroubů zafixován na místě, aby se zařízení při přepravě nepoškodilo. Zajišťovací transportní prvky se musí před uvedením do provozu sundat.

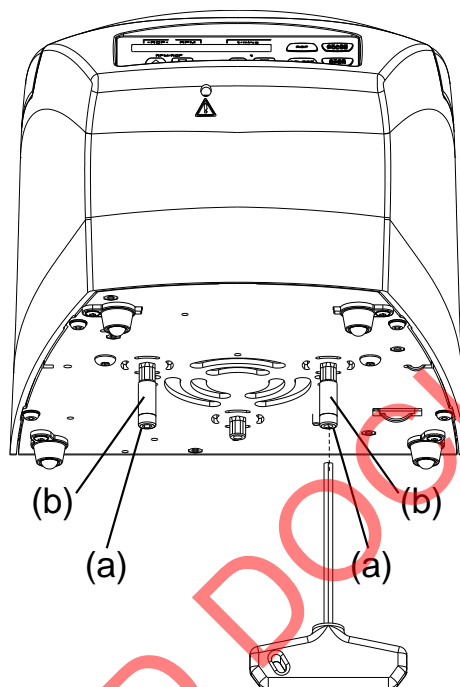

13.1 ÚVODNÍ SPUŠTĚNÍ

- Odstraňte ze spodní části centrifugy zajišťovací transportní prvky.
- Umístěte centrifugu na rovný, stabilní povrch na vhodném místě. Když je centrifuga spuštěná, nesmí být v jejím okolí žádné osoby, nebezpečné látky či předměty, a to v bezpečnostní vzdálenosti minimálně 300 mm.
- Odvětrávací průduchy nesmí být blokovány. Kolem odvětrávacích průduchů a otvorů musí být zajištěn volný prostor v minimální vzdálenosti 300 mm.
- Ujistěte se, že napětí v síti odpovídá napětí uvedenému na typovém štítku přístroje.
- Připojte k centrifuze síťový kabel a zapojte ho do zásuvky.
- Zapněte hlavní spínač.
- Na displeji ovládacího panelu se zobrazí následující informace: typ modelu centrifugy, verze softwaru a naposledy použité konfigurační údaje.
- Je-li víko zavřené, zobrazí se na displeji zpráva „Open the lid“ („Otevřete víko“). V takovém případě se na displeji zobrazí konfigurační údaje až poté, co otevřete víko.



13.2 OTEVÍRÁNÍ A ZAVÍRÁNÍ VÍKA CENTRIFUGY

Víko lze otevřít pouze v případě, že je centrifuga zapnutá a rotor se nehýbe. Je-li aktivováno počítadlo cyklů, zobrazí se na displeji po otevření víka po ukončení odstředovacího cyklu zbývající počet cyklů (odstředovacích cyklů v centrifuze).



Příklad:



Víko otevřete stisknutím tlačítka . Víko se odblokuje motorem. Symbol  značí, že je víko odblokováno.



Příklad:

Nesahejte mezi víko a kryt přístroje. Víko se nesmí zavírat silným zabouchnutím.

Chcete-li víko zavřít, stačí lehce stisknout přední část víka směrem dolů. Symbol  značí, že je víko uzavřeno a zablokováno.



Příklad:

13.3 NOUZOVÉ ODBLOKOVÁNÍ

Dojde-li k výpadku proudu, nemůže být víko odblokováno motorem. V takovém případě se musí víko nouzově odblokovat ručně. Pro nouzové odblokování vypněte hlavní spínač (spínač je v poloze „0“). Ujistěte se pohledem skrze okénko ve víku, že se rotor nehýbe. Víko můžete otevřít pouze v případě, že se rotor netočí. Vložte do příslušné zdičky (A) horizontálně imbusový klíč a opatrně s ním otáčejte proti směru hodinových ručiček (doleva), dokud se víko neotevře. POZOR! Otáčením imbusového klíče po směru hodinových ručiček (doprava) se může poškodit uzamykací systém. Vyměňte imbusový klíč ze zdičky.

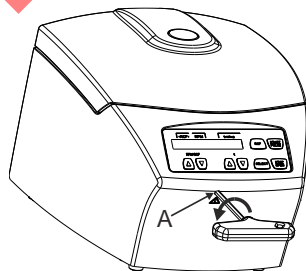

13.4 INSTALACE A VYJMUTÍ ROTORU

Před vyjmutím rotoru povolte upínací matici rotoru pomocí imbusového klíče (je součástí dodávky), kterým otáčejte proti směru hodinových ručiček, dokud neucítíte zvedací tlak. Až překonáte bod, kdy je cítit zvedací tlak, uvolní se rotor z kónické kleštiny motoru. Otáčejte upínací maticí, dokud nebude možné zdvihnout rotor z upínací kleštiny. Vyjměte rotor z upínací kleštiny motoru.

Před instalací rotoru vyčistěte kleštinu motoru (A) a zdíčku na rotor a potřete kleštinu motoru tenkou vrstvou maziva. Nečistoty usazené mezi kleštinou motoru a rotorem znemožňují dokonalé usazení rotoru a způsobují, že rotor nefunguje stabilně. Vložte rotor vertikálně do kleštiny motoru. Při usazování rotoru musí být vyznačená ryska (B) na rotoru rovnoběžná s oběma povrchy (C) na kleštině motoru. Otáčením imbusového klíče (je součástí dodávky) po směru hodinových ručiček utáhněte upínací matici rotoru. Zkontrolujte, zda je rotor v přístroji pevně usazen.

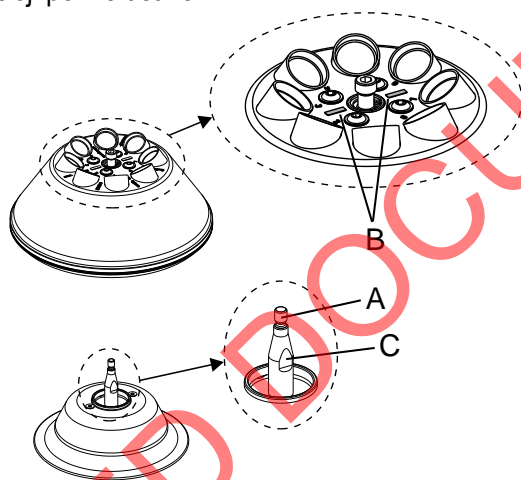

Rotor musí být zatížen vždy symetricky. Zkumavky na krev musí být rovnoměrně rozloženy na všech pozicích rotoru.



Zkumavky se musí plnit krví mimo centrifugu. Maximální možná úroveň naplnění je uvedena přímo na zkumavkách a nesmí překročit maximální hmotnost uvedenou na rotoru. Zkumavky mohou být naplněny pouze tak, aby z nich během odstředování neunikala žádná tekutina. Při ukládání zkumavek do rotoru nesmí do rotoru ani odstředovací komory uniknout žádná tekutina. Aby byly váhové rozdíly v centrifuze co nejmenší, doporučujeme plnit všechny odběrové zkumavky konzistentně do stejné úrovně.

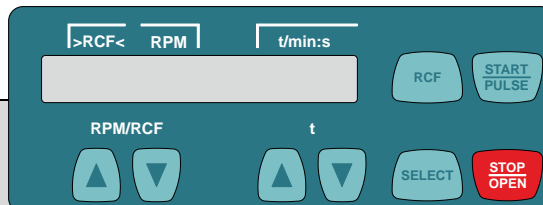

13.5 POPIS SYMBOLŮ A TLAČÍTEK NA DISPLEJI



Symbol / Tlačítko na panelu	Popis symbolu, funkce tlačítka
	Odblokované víko
	Zablokované víko
	Otáčení na displeji. Otáčení na displeji se rozsvítí po spuštění rotoru a otáčí se po směru hodinových ručiček v průběhu otáčení rotoru.
	Zadávání rychlosti otáčení napřímo. Pokud tlačítko držíte stisknuté, mění se hodnota rychleji.
	Zadávání doby odstředování napřímo. Načítá se po 1 vteřině až do času 1 minuta a poté po minutách. Zadávání parametrů centrifugace. Pokud tlačítko držíte stisknuté, mění se hodnota rychleji.
	Aktivace jednotlivých parametrů. Stisknutím tlačítka se vždy aktivuje následující parametr. Podržíte-li tlačítko stisknuté 8 vteřin, otevře se „Menu přístroje“ („Machine menu“). V menu přístroje zvolte možnost -> „Info“, -> „Settings“ („Nastavení“) a „Time & Cycles“ („Doba odstředování a cykly“). Procházení jednotlivých parametrů v menu.
	Přepínání mezi zobrazením rychlosti na displeji (RPM – ot./min.) a zobrazením relativní centrifugační síly (RCF). Hodnoty RCF se zobrazují mezi šipkami ><.
	Spuštění odstředovacího cyklu centrifugy. Používá se u krátkého odstředování. Cyklus běží tak dlouho, dokud je tlačítko stisknuté. Výběr z nabídky -> „Info“, -> „Settings“ („Nastavení“) a „Time & Cycles“ („Doba odstředování a cykly“).
	Ukončení odstředovacího cyklu. Rotor se postupně zastaví podle předem nastavené fáze zpomalování. Dvojitým stisknutím tlačítka vyvoláte nouzové zastavení. Odblokování víka.
t/min	Doba odstředování. Lze nastavit na hodnotu 1–99 minut (při nastavování narůstá po 1 minutě).
t/sec	Doba odstředování. Lze nastavit na hodnotu 1–59 vteřin (při nastavování narůstá po 1 vteřině). Neukončené odstředování: „--:--“. Nastavte parametry t/min a t/sec na nulu.
RPM	Rychlost (otáčky za minutu). Lze nastavit číselnou hodnotu od 200 RPM do maximální rychlosti rotoru. Při nastavování narůstá po 10.
>RCF<	Relativní centrifugační síla. Lze nastavit číselnou hodnotu, která odpovídá rychlosti od 200 RPM do maximální rychlosti rotoru. Při nastavování narůstá po 1. Zadat relativní centrifugační sílu (RCF) je možné pouze v případě, že je na displeji aktivováno zobrazení RCF (>RCF<). Relativní centrifugační síla (RCF) závisí na poloměru

	rotoru centrifugy (RAD). Po zadání RCF zkontrolujte, zda je v přístroji nastavený správný poloměr rotoru centrifugy.
RAD/mm	Poloměr rotoru centrifugy. Lze nastavit od 10 mm do 250 mm (při nastavování narůstá po 1 mm). Zadat poloměr rotoru centrifugy je možné pouze v případě, že je na displeji aktivováno zobrazení RCF (>RCF<).
~_DEC	Fáze zpomalování. Rychlé („fast“) = krátký dojezd, pomalé („slow“) = dlouhý dojezd.

13.6 PŘÍMÉ ZADÁVÁNÍ CENTRIFUGAČNÍCH PARAMETRŮ

Rychlost (RPM – ot./min.), relativní centrifugační sílu (RCF), poloměr rotoru centrifugy (RAD) a dobu odstředování lze zadat ručně pomocí tlačítek  , aniž by předtím bylo potřeba stisknout tlačítko . Zadané centrifugační parametry se uloží až po spuštění odstředovacího cyklu.

Rychlost (RPM):



Zobrazení otáček (RPM) na displeji aktivujete stisknutím tlačítka RCF.



Pomocí tlačítek s šipkami nastavte požadovanou hodnotu.

Příklad:

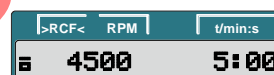

Relativní centrifugační síla (RCF) a poloměr rotoru centrifugy (RAD):



Zobrazení RCF (>RCF<) na displeji aktivujete stisknutím tlačítka RCF.



Pomocí tlačítek s šipkami nastavte požadovanou hodnotu RCF.

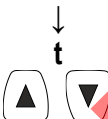

Pomocí tlačítek s šipkami nastavte požadovanou hodnotu poloměru.

Příklad:

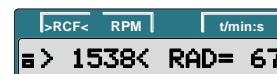
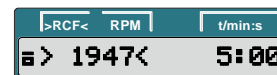

Doba odstředování:

Doba odstředování se zadává po 1 vteřině až do času 1 minuta a poté po minutách. Chcete-li nastavit neukončené odstředování, musíte parametry **t/min** a **t/sec** vynulovat. Na displeji se na místě zbývajících času (t/min:s) zobrazí „--:--“.



t Pomocí tlačítek s šípkami nastavte požadovanou hodnotu.

Příklad:

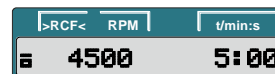

13.7 ZADÁVÁNÍ CENTRIFUGAČNÍCH PARAMETRŮ POMOCÍ TLAČÍTKA „SELECT“

Dobu odstředování lze zadat v minutách a vteřinách (parametry **t/min** a **t/sec**). Chcete-li nastavit neukončené odstředování, musíte parametry **t/min** a **t/sec** vynulovat. Na displeji se na místě zbývajících času (t/min:s) zobrazí „--:--“.

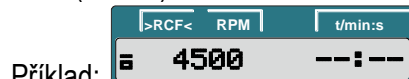

Relativní centrifugační síla (RCF) závisí na poloměru rotoru centrifugy (RAD). Po zadání RCF zkontrolujte, zda je v přístroji nastaven správný poloměr rotoru centrifugy. Pokud po dobu 8 vteřin po zvolení parametru nebo v průběhu jeho zadávání nestisknete žádné tlačítko, zobrazí se na displeji předchozí hodnota. Novou hodnotu parametru musíte poté zadat znovu. Stisknutím tlačítka **START PULSE** se nově nastavená hodnota uloží. Pokud zadáváte více parametrů, stiskněte tlačítko **START PULSE** po zadání posledního parametru. Zadávání parametrů můžete kdykoli zrušit stisknutím tlačítka **STOP OPEN**. V takovém případě se nově nastavené hodnoty neuloží.

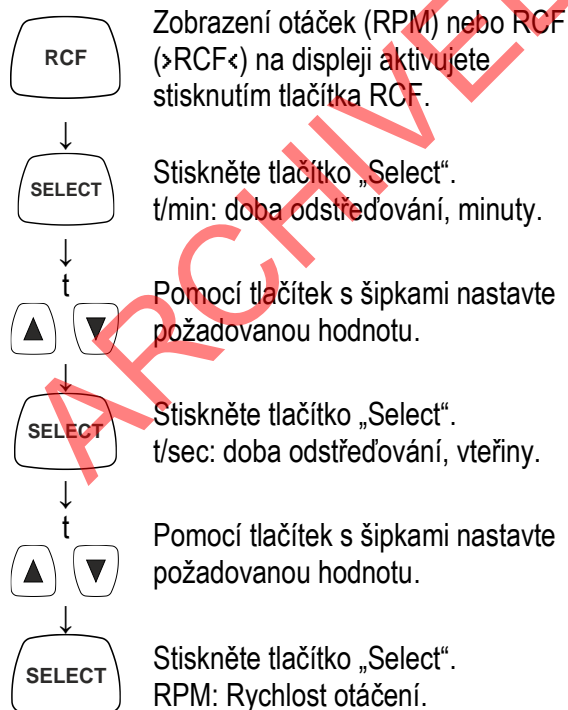

Příklad: zobrazení (RPM)

Příklad: zobrazení (>RCF<)

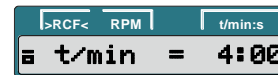
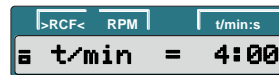
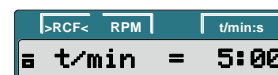
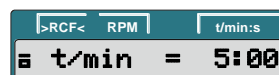
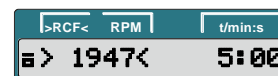
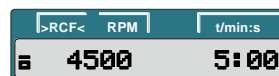

RAD/mm: Poloměr rotoru centrifugy.
Zadat poloměr rotoru centrifugy je možné pouze v případě, že je na displeji aktivováno zobrazení RCF (>RCF<).

↓

↑ ↓

Pomocí tlačítek s šipkami nastavte požadovanou hodnotu.

SELECT

Stiskněte tlačítko „Select“.
R: Poloměr rotoru centrifugy.
RCF: Relativní centrifugační síla.

↑ ↓

Pomocí tlačítek s šipkami nastavte požadovanou hodnotu.

SELECT

Stiskněte tlačítko „Select“.
~_DEC: Fáze zpomalování.
rychlé („fast“): krátký dojezd.
pomalé („slow“): dlouhý dojezd.

↑ ↓

Pomocí tlačítek s šipkami nastavte požadovanou hodnotu.

START PULSE

Stisknutím tlačítka „Start/Pause“ se nastavení uloží.

Display screens showing the following values:

- RPM = 4000
- RAD/mm = 67
- R: 67 RCF = 1947
- R: 67 RCF = 1198
- ~_DEC = slow
- ~_DEC = slow
- ~_DEC = fast
- ~_DEC = fast
- RPM = 4000, t/min:s = 4:30
- > 1198 <, t/min:s = 4:30

13.8 ZOBRAZENÍ NA DISPLEJI OVLÁDACÍHO PANELU

Po ukončení odstředovacího cyklu se na displeji v průběhu otevírání víka krátce zobrazí zbývající počet cyklů (odstředovacích cyklů v centrifuze).

Příklad:

Pokud systém zaznamená nerovnoměrnou zátěž rotoru nad povolenou hmotnostní odchylku, odstředovací cyklus se krátce po spuštění zastaví a na displeji se zobrazí nápis „IMBALANCE“ („nevyváženo“).

Příklad:

Odstředovací cyklus můžete kdykoli přerušit stisknutím tlačítka . V průběhu odstředovacího cyklu lze volit a měnit centrifugační parametry. Nově zadané hodnoty se však uplatní pouze u aktuálního odstředovacího cyklu a neuloží se do budoucna. Pomocí tlačítka můžete kdykoli přepínat mezi zobrazením rychlosti (RPM) a relativní centrifugační síly (>RCF<). Změníte-li nastavení RCF (>RCF<), musíte

zadat poloměr rotoru centrifugy. Další spuštění centrifugy je pak možné až po otevření víka. Na displeji se vždy objeví příslušné chybové hlášení.

Příklad:  („Otevřete víko“)

13.9 CENTRIFUGACE S PŘEDEM ZADANOU DOBOU Odstřeďování

 Zobrazení otáček (RPM) nebo RCF (>RCF<) na displeji aktivujete stisknutím tlačítka RCF.

Zadejte požadované centrifugační parametry.

 Odstřeďovací cyklus spustíte stisknutím tlačítka „Start/Pause“. V průběhu odstřeďovacího cyklu je na displeji zobrazena rychlost rotoru nebo odpovídající hodnota RCF a zbývající doba odstřeďování.

Po uplynutí zadané doby nebo po přerušení cyklu stisknutím tlačítka  je zahájen dojezd centrifugace podle zvolené fáze zpomalování. Na displeji je zobrazena zvolená fáze zpomalování ~_f.

Příklad: zobrazení (RPM)

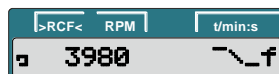
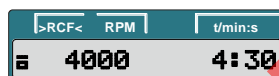
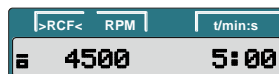

Příklad: zobrazení (>RCF<)

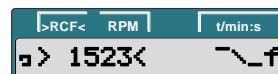
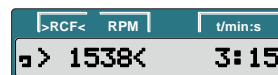

13.10 NEUKONČENÝ CYKLUS

 Zobrazení otáček (RPM) nebo RCF (>RCF<) na displeji aktivujete stisknutím tlačítka RCF.

Zadejte požadované centrifugační parametry. Vynulujte parametry t/min a t/sec.

 Odstřeďovací cyklus spustíte stisknutím tlačítka „Start/Pause“. V průběhu odstřeďovacího cyklu je na displeji zobrazena rychlost rotoru nebo odpovídající hodnota RCF a uplynulá doba odstřeďování.

Příklad: zobrazení (RPM)

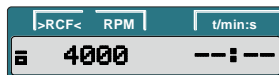
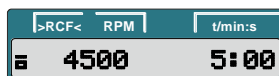

Příklad: zobrazení (>RCF<)

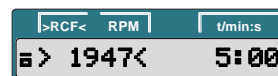



Odstředovací cyklus ukončíte stisknutím tlačítka „Stop/Open“. Poté je zahájen dojezd centrifugace podle zvolené fáze zpomalování. Na displeji je zobrazena zvolená fáze zpomalování \sim f.

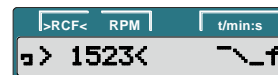
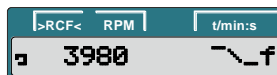

13.11 KRÁTKÉ ODSTŘEĐOVÁNÍ



Zobrazení otáček (RPM) nebo RCF (>RCF<) na displeji aktivujete stisknutím tlačítka RCF.

Příklad: zobrazení (RPM)

Příklad: zobrazení (>RCF<)

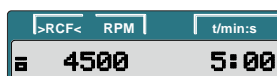

Zadejte požadované centrifugační parametry.

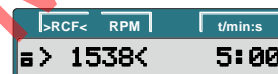
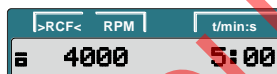

Stiskněte tlačítko „Start/Pause“ a držte ho stisknuté. V průběhu odstředovacího cyklu je na displeji zobrazena rychlost rotoru nebo odpovídající hodnota RCF a uplynulá doba odstředování.

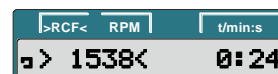

Odstředovací cyklus ukončíte puštěním tlačítka. Poté je zahájen dojezd centrifugace podle zvolené fáze zpomalování. Na displeji je zobrazena zvolená fáze zpomalování \sim f.

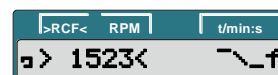

13.12 NOUZOVÉ ZASTAVENÍ



Stiskněte dvakrát tlačítko „Stop/Open“. Při nouzovém zastavení je aktivováno „rychlé“ zpomalení (krátký dojezd). Na displeji je zobrazena fáze zpomalování \sim f.

Příklad: zobrazení (RPM)

Příklad: zobrazení (>RCF<)



13.13 POČÍTADLO CYKLŮ

Přístroj je vybaven počítadlem cyklů, které sčítá počet provedených cyklů (odstředovacích cyklů v centrifuze). Po ukončení odstředovacího cyklu se na displeji v průběhu otevírání víka krátce zobrazí zbývající počet cyklů (odstředovacích cyklů v centrifuze).

Příklad: 

Pokud je překročen maximální povolený počet cyklů, zobrazí se na displeji vždy po spuštění centrifugy následující hlášení („cycles passed“). Odstředivací cyklus je třeba spustit znovu. Z bezpečnostních důvodů musí být rotor okamžitě vyměněn za nový. Po výměně rotoru se musí počítadlo cyklů vynulovat.

Příklad: 

13.14 VYNULOVÁNÍ POČÍTADLA CYKLŮ

Po výměně rotoru se musí počítadlo cyklů vynulovat. Počítadlo cyklů můžete vynulovat pouze v případě, že byl rotor vyměněn za nový. Vynulujte počítadlo dle následujícího postupu, rotor se v tu chvíli nesmí pohybovat. Postup můžete kdykoli přerušit stisknutím tlačítka . V takovém případě se zadané hodnoty neuloží.

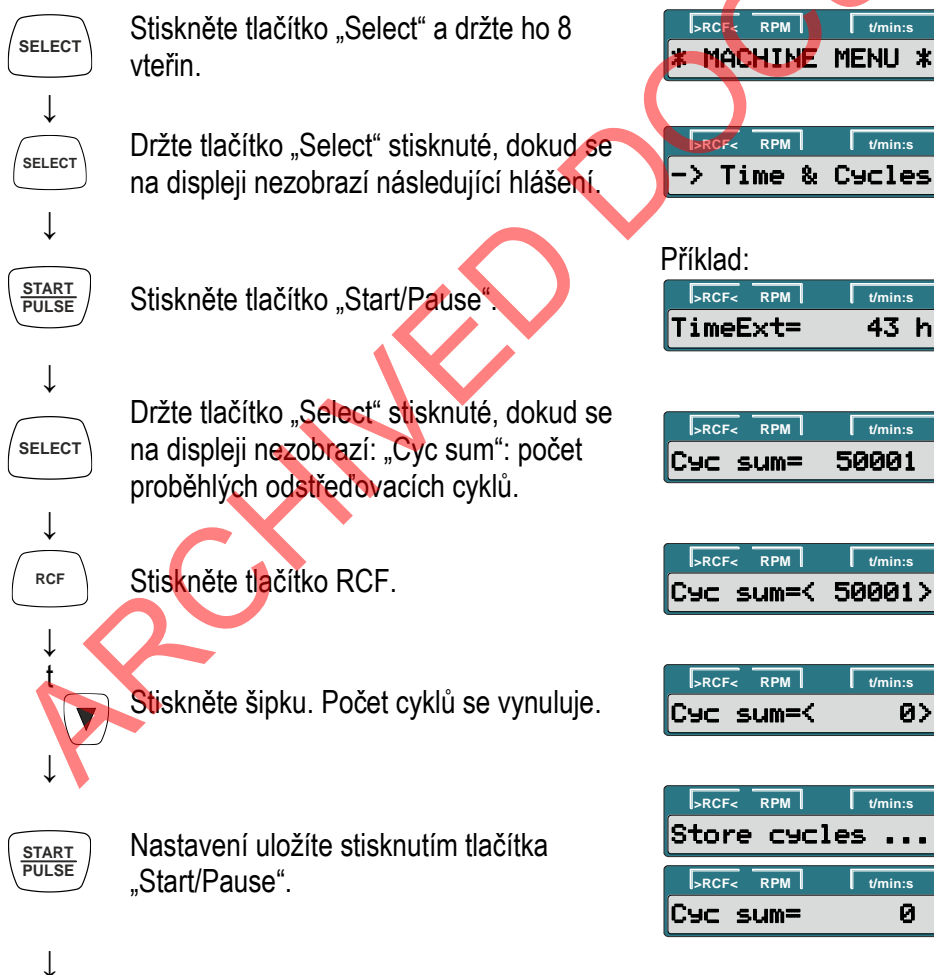



Dvojitým stisknutím tlačítka „Start/Open“ se vrátíte z menu „-> Time & Cycles“, stisknete-li tlačítko třikrát, vrátíte se z menu přístroje „* MACHINE MENU *“.

Příklad:

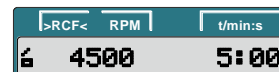

13.15 NASTAVENÍ A ZJIŠŤOVÁNÍ INFORMACÍ

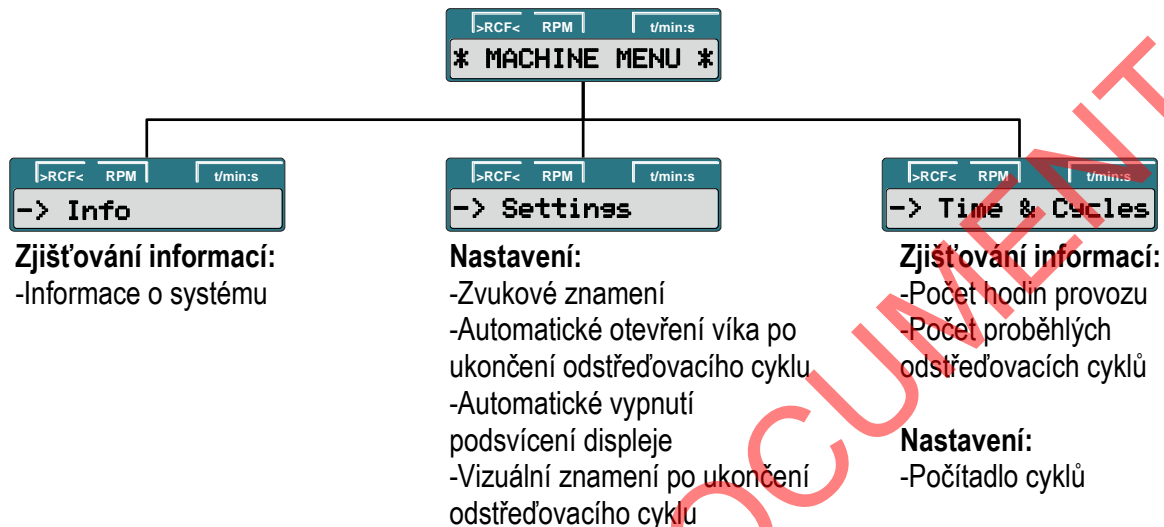

13.16 ZJIŠŤOVÁNÍ INFORMACÍ O SYSTÉMU

Můžete si vyžádat následující informace o systému:

- Model přístroje
- Verze programu v přístroji
- Číslo typu přístroje
- Datum výroby přístroje
- Sériové číslo přístroje
- Typ frekvenčního konvertoru
- Verze programu frekvenčního konvertoru

Požadované informace zjistíte následovně (rotor se během zjišťování informací nesmí pohybovat): Prohlížení můžete kdykoli přerušit stisknutím tlačítka .



Stiskněte tlačítko „Select“ a držte ho 8 vteřin.

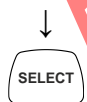

Stiskněte tlačítko „Select“.

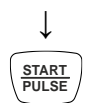

Stiskněte tlačítko „Start/Pause“.
Model přístroje.





Stiskněte tlačítko „Select“.
Verze programu v přístroji.



Stiskněte tlačítko „Select“.
Type#1: Číslo typu přístroje.



Stiskněte tlačítko „Select“.
Type#2: Pokračování čísla typu přístroje, pokud má více cifer, než se vejde do pole „Type#1“.



Stiskněte tlačítko „Select“.
Datum výroby přístroje.



Stiskněte tlačítko „Select“.
Sériové číslo přístroje.



Stiskněte tlačítko „Select“.
Typ frekvenčního konvertoru.



Stiskněte tlačítko „Select“.
Verze programu frekvenčního konvertoru.



Dvojitým stisknutím tlačítka „Start/Open“ se vrátíte z menu „-> Info“, stisknete-li tlačítko třikrát, vrátíte se z menu přístroje „* MACHINE MENU *“.

Příklad:

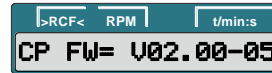

Příklad:

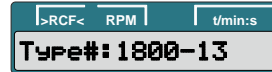

Příklad:

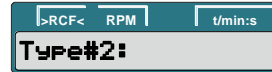

Příklad:

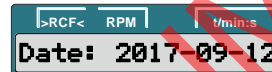

Příklad:

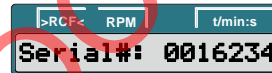

Příklad:



Příklad:



Příklad:

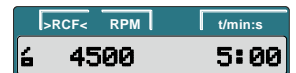

13.17 ZVUKOVÉ ZNAMENÍ

Zvukové znamení zazní (1) v případě poruchy, kdy se opakuje po 2 vteřinách, a (2) po ukončení odstředovacího cyklu, kdy se opakuje po 30 vteřinách. Zvukové znamení vypnete stisknutím kteréhokoli tlačítka. Zvukové znamení si můžete nastavit dle následujícího postupu, rotor se v tu chvíli nesmí pohybovat.

Postup můžete kdykoli přerušit stisknutím tlačítka . V takovém případě se zadané hodnoty neuloží.



Stiskněte tlačítko „Select“ a držte ho 8 vteřin.



Držte tlačítko stisknuté, dokud se na displeji nezobrazí:



Stiskněte tlačítko „Start/Pause“.

End beep: Pípání po ukončení odstředovacího cyklu.

off: Znamení deaktivováno.

on: Znamení aktivováno.

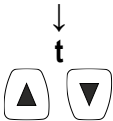

Pomocí tlačítek s šipkami nastavte požadovanou hodnotu **off** či **on**.



Stiskněte tlačítko „Select“.

Error beep: Pípání v případě poruchy.

off: Znamení deaktivováno.

on: Znamení aktivováno.

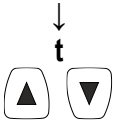

Pomocí tlačítek s šipkami nastavte požadovanou hodnotu **off** či **on**.



Stiskněte tlačítko „Select“.

Beep volume: Hlasitost zvukového znamení.

min: tiché

mid: střední

max: hlasité



Pomocí tlačítek s šipkami nastavte požadovanou hodnotu **min**, **mid** či **max**.



Nastavení uložíte stisknutím tlačítka „Start/Pause“.



Stisknutím tlačítka „Start/Open“ se vrátíte z menu „-> Settings“, stisknete-li tlačítko dvakrát, vrátíte se z menu přístroje „* MACHINE MENU *“.



Příklad:

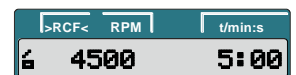

13.18 VIZUÁLNÍ ZNAMENÍ PO UKONČENÍ ODSTŘEĐOVACÍHO CYKLU

Podsvícení displeje začne po ukončení odstředovacího cyklu blikat, aby vizuálně upozornilo na ukončení centrifugace. Vizuální znamení lze zapnout či vypnout dle následujícího postupu, rotor se v tu chvíli nesmí pohybovat. Postup můžete kdykoli přerušit stisknutím tlačítka . V takovém případě se zadané hodnoty neuloží.

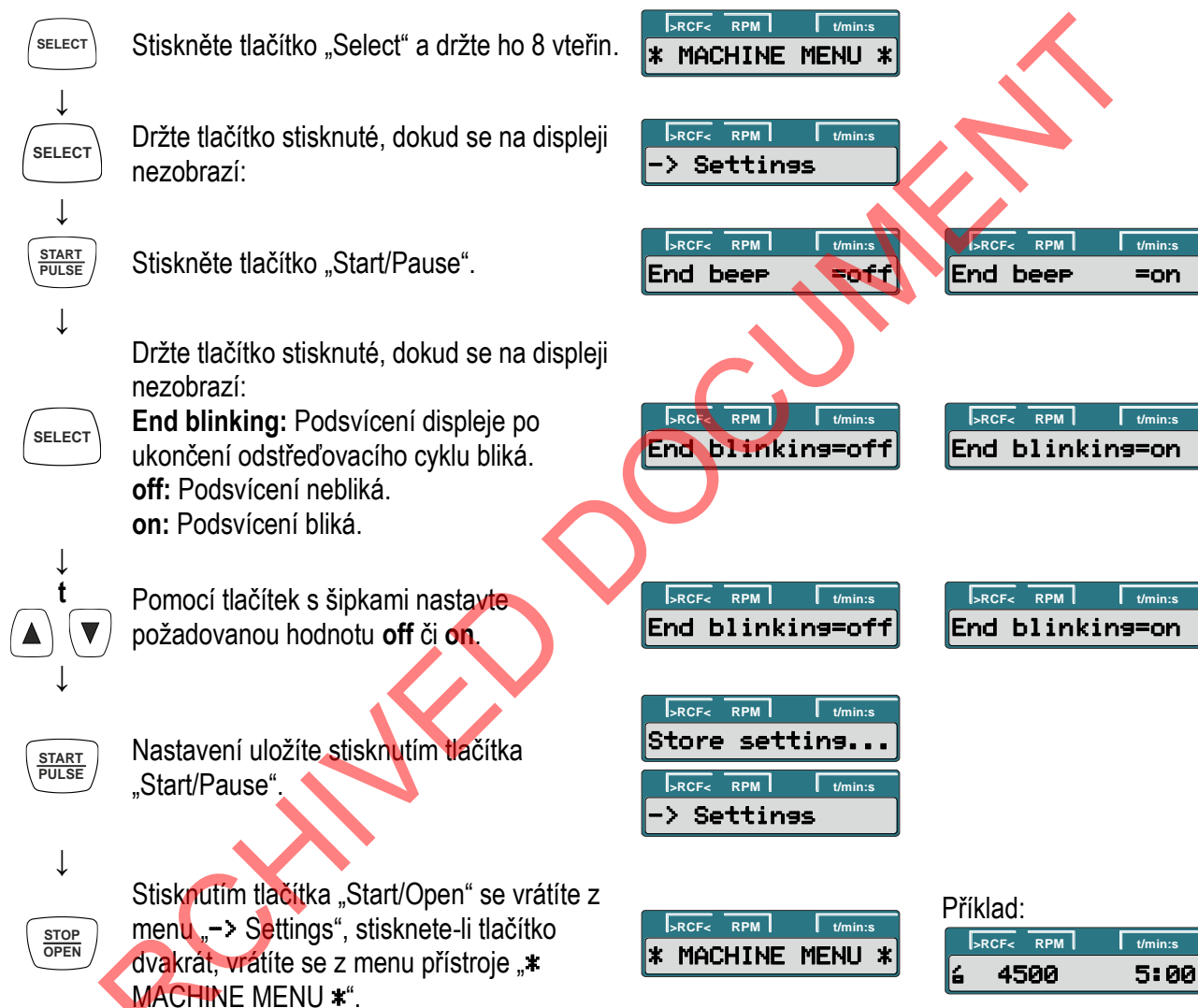

13.19 AUTOMATICKÉ OTEVŘENÍ VÍKA PO UKONČENÍ ODSTŘEĐOVACÍHO CYKLU

Můžete si nastavit, zda se má víko centrifugy po ukončení odstředovacího cyklu automaticky otevřít, či ne. Nastavení provedete dle následujícího postupu, rotor se v tu chvíli nesmí pohybovat. Postup můžete kdykoli přerušit stisknutím tlačítka . V takovém případě se zadané hodnoty neuloží.



Stiskněte tlačítko „Select“ a držte ho 8 vteřin.



Držte tlačítko stisknuté, dokud se na displeji nezobrazí:



Stiskněte tlačítko „Start/Pause“.



Držte tlačítko stisknuté, dokud se na displeji nezobrazí:



Lid AutoOpen: Automatické otevření víka po ukončení odstředovacího cyklu.
off: Víko se automaticky neotevře.
on: Víko se automaticky otevře.

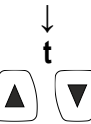

Pomocí tlačítek s šipkami nastavte požadovanou hodnotu **off** či **on**.



Nastavení uložíte stisknutím tlačítka „Start/Pause“.

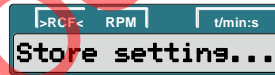

Stisknutím tlačítka „Start/Open“ se vrátíte z menu „-> Settings“, stisknete-li tlačítko dvakrát, vrátíte se z menu přístroje „* MACHINE MENU *“.



Příklad:



13.20 PODSVÍCENÍ DISPLEJE

Z důvodu úspory energie si můžete nastavit, aby podsvícení displeje po 2 minutách od ukončení odstředovacího cyklu zhaslo. Nastavení provedete dle následujícího postupu, rotor se v tu chvíli nesmí pohybovat. Postup můžete kdykoli přerušit stisknutím tlačítka . V takovém případě se zadané hodnoty neuloží.



Stiskněte tlačítko „Select“ a držte ho 8 vteřin.



Držte tlačítko stisknuté, dokud se na displeji nezobrazí:





Stiskněte tlačítko „Start/Pause“.



Držte tlačítko stisknuté, dokud se na displeji nezobrazí:



Power save: Úspora energie – automatické zhasnutí podsvícení.

off: Automatické zhasnutí deaktivováno.

on: Automatické zhasnutí aktivováno.



Pomocí tlačítek s šipkami nastavte požadovanou hodnotu **off** či **on**.



Nastavení uložíte stisknutím tlačítka „Start/Pause“.

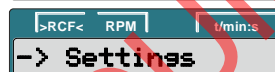

Stisknutím tlačítka „Start/Open“ se vrátíte z menu „-> Settings“, stisknete-li tlačítko dvakrát, vrátíte se z menu přístroje „* MACHINE MENU *“.



Příklad:

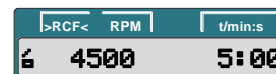

13.21 ZJIŠŤOVÁNÍ POČTU HODIN PROVOZU A POČTU PROBĚHLÝCH ODSTŘEĐOVACÍCH CYKLŮ

Hodiny provozu se dělí na interní a externí. Počet interních hodin provozu: Celková doba, po kterou byl přístroj zapnutý. Počet externích hodin provozu: Celková doba proběhlých odstředovacích cyklů. Informace zjistíte dle následujícího postupu, rotor se v tu chvíli nesmí pohybovat. Postup můžete kdykoli přerušit stisknutím tlačítka . V takovém případě se zadané hodnoty neuloží.



Stiskněte tlačítko „Select“ a držte ho 8 vteřin.



Držte tlačítko stisknuté, dokud se na displeji nezobrazí:



Stiskněte tlačítko „Start/Pause“.

TimeExt: Počet externích hodin provozu.

Příklad:





Stiskněte tlačítko „Select“.
TimeInt: Počet interních hodin provozu.

Příklad:

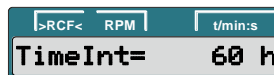

Stiskněte tlačítko „Select“.
Starts: Počet odstředovacích cyklů.

Příklad:



Dvojitým stisknutím tlačítka „Start/Open“ se vrátíte z menu „-> Time & Cycles“, stisknete-li tlačítko třikrát, vrátíte se z menu přístroje „* MACHINE MENU *“.

Příklad:





14 PORUCHY

Pokud není možné poruchu odstranit dle pokynů v následující tabulce, obraťte se prosím na zákaznickou podporu a uveďte sériové číslo a typ centrifugy. Obě čísla naleznete na typovém štítku na centrifuze.



Jak zařízení RESTARTOVAT: Vypněte hlavní spínač (spínač je v poloze „0“). Vyčkejte alespoň 10 vteřin a poté zařízení pomocí hlavního spínače opět zapněte (spínač je v poloze „I“).

Chybové hlášení / porucha		Příčina	Oprava
No display (displej nesvítí)		Do přístroje nejde proud. Přepálily se pojistky zařízení.	<ul style="list-style-type: none"> – Zkontrolujte přívod proudu ze sítě. – Zkontrolujte pojistky a případně je vyměňte dle pokynů níže. – Zapněte hlavní spínač (ON).
IMBALANCE (nevyváženo)		Rotor není zatížen rovnoměrně.	<ul style="list-style-type: none"> – Po zastavení rotoru otevřete víko. – Zkontrolujte zatížení rotoru. – Opakujte odstředovací cyklus.
MAINS INTER (přerušen přívod proudu)	11	Výpadek proudu během odstředovacího cyklu. (Odstředovací cyklus nebyl dokončen.)	<ul style="list-style-type: none"> – Po zastavení rotoru otevřete víko. – Stiskněte tlačítko „start/pause“. – V případě potřeby opakujte odstředovací cyklus.
MAINS INTERRUPT (přerušen přívod proudu)			
TACHO ERROR (chyba měření rychlosti)	1, 2	Chybné rychlostní impulzy během chodu.	<ul style="list-style-type: none"> – Po zastavení rotoru restartujte zařízení.
LID ERROR (chyba víka)	4.1–4.127	Chyba uzavření či zablokování víka.	
OVER SPEED (nadměrná rychlost)	5	Rotor se otáčí příliš rychle.	
VERSION ERROR (chyba verze)	12	Nebyl rozpoznán správný model centrifugy. Chyba/závada na elektronice.	<ul style="list-style-type: none"> – Po zastavení rotoru restartujte zařízení.

UNDER SPEED (nízká rychlost)	13	Rotor se otáčí příliš pomalu.	
CTRL ERROR	22.1, 25.2	Chyba/závada na elektronice.	
CRC ERROR	27.1		
COM ERROR	31–36		
FC ERROR	60, 61.1–61.21, 61.64–61.142		
FC ERROR	61.23	Chyba při měření rychlosti.	– Přístroj nelze vypnout, dokud na displeji svítí symbol  a otáčí se dokola. Vyčkejte, dokud se na displeji nezobrazí symbol  (zablokované víko – po zhruba 120 vteřinách). Poté zařízení restartujte.
TACHO ERR	61.22		
FC ERROR	61.153	Chyba/závada na elektronice.	– Restartujte zařízení. – Zkontrolujte zatížení rotoru dle příslušných pokynů. – Opakujte odstředovací cyklus.

15 RELATIVNÍ CENTRIFUGAČNÍ SÍLA (RCF)

Relativní centrifugační síla (RCF) je násobkem gravitačního zrychlení (g). Je to hodnota bez jednotky a slouží k porovnání účinnosti separace a sedimentace. Relativní centrifugační síla (RCF) je přímo úměrná otáčkám za minutu a poloměru rotoru. Lze ji spočítat podle níže uvedeného vzorce:

$$RCF = \left(\frac{RPM}{1000}\right)^2 \times r \times 1.118 \Rightarrow RPM = \sqrt{\frac{RCF}{r \times 1.118}} \times 1000$$

RCF = relativní centrifugační síla

RPM = rychlost otáček (otáčky za minutu)

r = poloměr rotoru centrifugy v mm = vzdálenost od středu osy otáčení ke dnu centrifugy.

16 PŘEPRAVA A SKLADOVÁNÍ

Před přepravou přístroje je třeba nainstalovat zajišťovací transportní prvky. Přístroj a jeho příslušenství se musí uchovávat v uzavřené, suché místnosti. Při přepravě či skladování přístroje a jeho příslušenství musí být splněny následující podmínky:

Teplotní rozmezí: -20 °C až +60 °C.

Rozmezí relativní vlhkosti: 10 % až 80 %, nekondenzující.

17 VÝMĚNA POJISTEK

Nejprve vypněte hlavní spínač a vypojte přístroj ze zásuvky. Příhrádka na pojistky (A) se síťovými pojistkami se nachází vedle hlavního spínače. Odpojte ze zdířky přístroje síťový kabel. Zatlačte na zacvakávací destičku (B) ve směru proti příhradce (A) a vyjměte ji. Vyměňte vadné pojistky za nové. Používejte pouze pojistky, které jsou výrobcem určeny pro daný typ centrifugy. Příhrádku opět uzavřete destičkou tak, aby se zacvakla na místo. Opět přístroj zapojte do sítě.

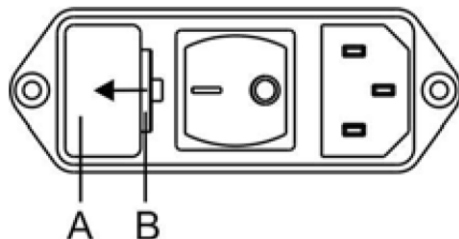

18 VRÁCENÍ PŘÍSTROJE

Než přístroj odešlete k vrácení, je třeba nainstalovat zajišťovací transportní prvky. Vracíte-li přístroj nebo jeho příslušenství výrobci, je třeba dbát na zajištění ochrany osob, životního prostředí a majetku a přístroj před odesláním dekontaminovat a řádně vyčistit. Výrobce si vyhrazuje právo odmítnout převzetí kontaminovaného přístroje či příslušenství. Náklady na čištění a dezinfekci musí uhradit zákazník.

19 LIKVIDACE

Aby byla zajištěna ochrana osob, životního prostředí a majetku, je třeba přístroj před likvidací dekontaminovat a řádně vyčistit. Při likvidaci zařízení dodržujte veškeré platné právní předpisy. V souladu se směrnicí 2002/96/EK (OEEZ) nemohou být žádná zařízení dodaná po 13. srpnu 2005 odstraňována do směsného odpadu z domácností. Zařízení patří do skupiny 8 (zdravotnické prostředky) a spadá do kategorie elektrozařízení určených pro podnikatele. Symbol přeškrtnuté popelnice znamená, že zařízení nelze vyhodit do směsného odpadu. Pokyny pro likvidaci odpadu se mohou v různých státech lišit. V případě dotazů se obraťte na svého dodavatele.