

tapered internal implant system



*high-end esthetic performance
and excellent primary stability*

BIOHORIZONS[®]
SCIENCE • INNOVATION • SERVICE

tapered implant family



The Tapered Internal family of dental implants provide excellent primary stability, maximum bone maintenance and soft tissue attachment for predictable results. All implants can be placed with the same instrument kit providing you surgical convenience and flexibility to choose the ideal implants for each patient's needs.



restorative ease
conical internal hex connection is color-coded for quick identification and component matching

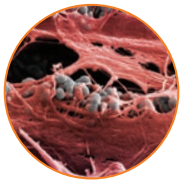

connective tissue attachment
uniquely creates a physical connective tissue attachment

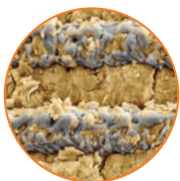

bone attachment
Laser-Lok® microchannels achieve superior osseointegration

universal surgical kit
intuitive color-coded instrumentation used to place all BioHorizons tapered implants



table of contents

tapered internal overview	2
implants	3
surgical kits	4
surgical instruments	5-6
ancillary instruments	7-8
w&h motors and instruments	9-10
healing abutments & cover caps	11-12
surgical manual introduction	13
surgical protocols	14
implant placement level & spacing	15
surgical kit & drill sequence	16
drill overview	17
osteotomy initialization	18
osteotomy modification	19
final bone preparation & drivers	20
implant transfer	21
healing protocols	22
appendix	23
icon legend & references	24
ordering & warranty information	25

tapered internal

Tapered Internal dental implants feature an anatomically tapered dental implant body, aggressive buttress threads and advanced Laser-Lok surface technology. The deep 1.5mm internal hex connection with a 45° tapered bevel create a rigid connection and a stable biologic seal.

- excellent primary stability from anatomically tapered body
- compressive bone loading from proprietary buttress threads
- stable soft tissue seal and flexible implant placement from Laser-Lok microchannels

Laser-Lok® zone

creates a connective tissue seal and maintains crestal bone

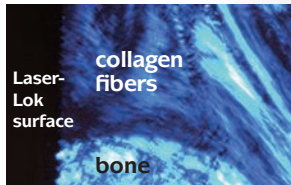

optimized threadform

buttress thread engineered for superior stability over microthreaded implants

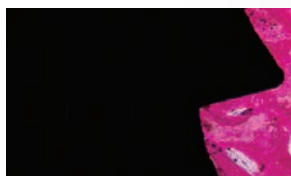

restorative choices

comprehensive line of internally hexed prosthetics for a wide variety of site conditions and restorative protocols



* histologic images are courtesy of Myron Nevins, DDS, and Peter Schupbach, PhD

Mount-free Tapered Internal Implants with Laser-Lok

Packaged mount-free for quick placement and maximum site visibility. Expanded Laser-Lok zone with no smooth, machined area. Includes a Cover Cap.



prosthetic connection	3.0mm	3.5mm	4.5mm	5.7mm
body diameter	3.0mm	3.8mm	4.6mm	5.8mm
Laser-Lok zone	2.1mm	1.8mm	1.8mm	1.8mm
7.5mm length	—	—	TLX4607	TLX5807
9.0mm length	—	TLX3809	TLX4609	TLX5809
10.5mm length	TLX3010	TLX3810	TLX4610	TLX5810
12.0mm length	TLX3012	TLX3812	TLX4612	TLX5812
15.0mm length	TLX3015	TLX3815	TLX4615	TLX5815

Tapered Internal Implants with Laser-Lok

Laser-Lok collar with Resorbable Blast Texturing (RBT) on implant body. Comes packaged with Cover Cap, Abutment Screw and pre-mounted 3inOne esthetic abutment that serves as a fixture mount, closed-tray transfer (when used with a ball-top screw) and final abutment. Titanium Alloy.



prosthetic connection	3.5mm	4.5mm	5.7mm
body diameter	3.8mm	4.6mm	5.8mm
Laser-Lok zone	1.5mm	1.5mm	1.5mm
7.5mm length	—	TLR4607	TLR5807
9.0mm length	TLR3809	TLR4609	TLR5809
10.5mm length	TLR3810	TLR4610	TLR5810
12.0mm length	TLR3812	TLR4612	TLR5812
15.0mm length	TLR3815	TLR4615	TLR5815

Short Tapered Internal Implants with Laser-Lok Complete

Laser-Lok surface technology across the entire implant body with no machined collar for faster osseointegration¹ and higher bone to implant contact. Ideal for anatomically challenging conditions. Packaged with Cover Cap. Mount-free delivery. Titanium Alloy.

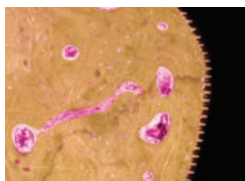

Histology of a buttress thread with Laser-Lok showing exceptional bone attachment.



prosthetic connection	4.5mm	5.7mm
body diameter	4.6mm	5.8mm
7.5mm length	TL4607	TL5807
9.0mm length	TL4609	TL5809

¹ histologic image is courtesy of Myron Nevins, DDS, and Peter Schupbach, PhD

SURGICAL KITS

Universal Surgical Kit

TSK3000*

Universal Surgical Kit

Includes the instrumentation required to place:
Tapered Internal, Tapered 3.0, Tapered Plus and Laser-Lok 3.0

TSK2500*

Surgical Tray & Lid (without instruments)



features:

- versatile, removable, hinged lid
- 40% smaller and 40% lighter than other kits
- easy to disassemble and assemble during cleaning
- implant staging area for implant vials during surgery
- use to place Tapered Internal, Tapered 3.0, Tapered Plus and Laser-Lok 3.0
- empty spare slots for other instrumentation such as stop drills or extended shank drills



Tapered Internal Surgical Kit

TSK2021

Tapered Internal Surgical Kit

Includes the instrumentation to place 3.8/4.6/5.8mm Tapered Internal implants ONLY. Tapered 3.0 instrumentation sold separately.

TSK2011

Tapered Internal Tray & Lid (without instruments)



* not available in all markets

SURGICAL INSTRUMENTS

Individual Components



TSD2020
2.0mm Starter Drill (matte finish)

TSD2025
2.5mm Depth Drill (matte finish)



122-100
Drill Extender
(adds 16mm to length of drill)



144-100
Straight Parallel Pin

144-200
20° Angled Parallel Pin



TSD2032 3.2mm Width Increasing Drill (matte finish)

TSD2037 3.7mm Width Increasing Drill (matte finish)

TSD2041 4.1mm Width Increasing Drill (matte finish)

TSD2047 4.7mm Width Increasing Drill (matte finish)

TSD2054 5.4mm Width Increasing Drill (matte finish)



TP3CBD* 3.0mm Crestal Bone Drill

TSC2038 3.8mm Crestal Bone Drill

TSC2046 4.6mm Crestal Bone Drill

TSC2058 5.8mm Crestal Bone Drill



122-900* 3.0mm Bone Tap

TST2038 3.8mm Bone Tap

TST2046 4.6mm Bone Tap

TST2058 5.8mm Bone Tap



TDG2030* 3.0mm Depth Gauge

TDG2038 3.8mm Depth Gauge

TDG2046 4.6mm Depth Gauge

TDG2058 5.8mm Depth Gauge

Important Note about drills

Drills, taps and depth gauges are color coded by implant body diameter:

- 3.0mm body - no color indicator
- 3.8mm body - yellow
- 4.6mm body - green
- 5.8mm body - blue

* specific 3.0 instruments are only included in the TSK3000, not the TSK2021

SURGICAL INSTRUMENTS

Individual Components



300-400
Hand Wrench, 4mm Square



300-206
4mm Square Drive Extender



135-351
.050" (1.25mm) Hex Driver



130-000
Ratchet



PHA Abutment-level Driver, Handpiece
PRA Abutment-level Driver, Ratchet



TP3IDHR* 3.0mm Implant-level Driver, Regular, Handpiece
TP3IDRR* 3.0mm Implant-level Driver, Regular, 4mm Square



SYGIDH 3.5/4.5mm Implant-level Driver, Handpiece
SYGIDR 3.5/4.5mm Implant-level Driver, 4mm Square



SBIDH 5.7mm Implant-level Driver, Handpiece
SBIDR 5.7mm Implant-level Driver, 4mm Square

Important Note about drivers

Drivers are color coded by prosthetic connection:

- 3.0mm platform - no color indicator
- 3.5mm platform - yellow
- 4.5mm platform - green
- 5.7mm platform - blue

* Specific 3.0 instruments are only included in the TSK3000, not the TSK2021. The 3.0mm implant-level drivers are available in longer versions.

ANCILLARY INSTRUMENTS

2.5mm Tapered Depth Drills with stops



TSD202507	2.5mm Tapered Depth Drill, 7.5mm Stop
TSD202509	2.5mm Tapered Depth Drill, 9mm Stop
TSD202510	2.5mm Tapered Depth Drill, 10.5mm Stop
TSD202512	2.5mm Tapered Depth Drill, 12mm Stop
TSD202515	2.5mm Tapered Depth Drill, 15mm Stop

Stops are set to same length as each implant for crestal placement.
Laser-etched line set 1 mm shorter for supracrestal placement.

Extended Shank Drills



TSD4020	2.0mm Ext. Shank Starter Drill
TSD4025	2.5mm Ext. Shank Depth Drill
TSD4032	3.2mm Ext. Shank Width Increasing Drill
TSD4037	3.7mm Ext. Shank Width Increasing Drill
TSD4041	4.1mm Ext. Shank Width Increasing Drill
TSD4047	4.7mm Ext. Shank Width Increasing Drill
TSD4054	5.4mm Ext. Shank Width Increasing Drill

Extended Shank Drills are 8mm longer than our standard drills.

Burs



122-110	2.0mm Lindemann Bone Cutter
----------------	------------------------------------

Side-cutting drill used to correct eccentric osteotomy preparations.

122-106	#6 Round Bur
----------------	---------------------

Bone Profiling Burs



TP3BP	3.0mm Bone Profiling Bur & Guide
PYBP	3.5mm Bone Profiling Bur & Guide
PGBP	4.5mm Bone Profiling Bur & Guide
PBBP	5.7mm Bone Profiling Bur & Guide

Use at implant uncover to remove excess crestal bone for proper abutment seating.
Screw the guide into the implant and align the profiling bur for precise bone removal.
Match profiler & guide color to prosthetic connection.

ANCILLARY INSTRUMENTS

Tissue Punches



- 122-200** 3.0mm Tissue Punch (for a 3.3mm incision)
- PYTP** 3.5mm Tissue Punch (for a 3.9mm incision)
- PGTP** 4.5mm Tissue Punch (for a 4.7mm incision)
- PBTP** 5.7mm Tissue Punch (for a 6.1mm incision)

Use in flapless surgical procedures to remove a minimal amount of the soft tissue from the crest of the ridge prior to osteotomy preparation or during implant uncoverly.

Handpiece Hex Drivers

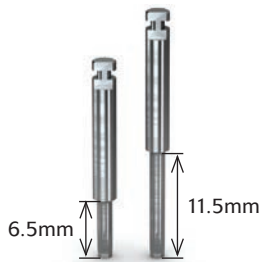

- 134-350** .050" (1.25mm) Handpiece Hex Driver
- 134-450** .050" (1.25mm) Handpiece Hex Driver, Long

For installation and removal of cover screws, healing abutments and abutment screws. The handpiece hex drivers are used with latch-type contra-angle handpieces. The Handpiece Hex Driver, Long (134-450) is 5mm longer than the standard version (134-350).

Adjustable Torque Wrenches



EL-C12374 Elos Adjustable Torque Wrench

Lightweight titanium design is easy to use as a ratchet or adjustable torque wrench with visual indicators for 30, 40, 50, 60, 70, 80 and 90 Ncm. Comes packaged with a 4mm square adaptor. Quickly disassembles for cleaning. No calibration required.



ATW ITL Precise Adjustable Torque Wrench

Place both implants and abutments with 9 distinct torque settings (15, 20, 25, 30, 35, 40, 45, 50 and 60 Ncm). A simple twist of the handle locks in precision-engineered torque values and guarantees accuracy and repeatability. Fits any 4mm square component.

Surgical Driver



150-000 Surgical Driver

Use to drive implants into the osteotomy, particularly in the anterior region. Holds the 4mm Square implant-level drivers and the bone taps.

Implant Spacer / Depth Probe



144-300 Implant Spacer / Depth Probe

Use to provide intraoral measurements. Multi-functional tool for marking implant spacing on the ridge and probing osteotomy depth. Included in the TSK2021. Must be purchased separately for the TSK3000.

W&H MOTORS AND ACCESSORIES

W&H Motor Kits

Motor Kits include: console, handheld motor with cable, foot pedal, (3) disposable irrigation tubes, handpiece, bur testing gauge, service oil, and oil spray cap.



WH-310L Elcomed SA-310 Professional Kit with LED

Includes WS-75 LED handpiece (WH-10207530)

WH-310 Elcomed SA-310 Professional Kit

Includes WS-75 handpiece (WH-10207510)



WH-915L Implantmed SI-915 Starter Kit with LED

Includes WI-75 LED handpiece (WH-10207560)

WH-915 Implantmed SI-915 Starter Kit

Includes WI-75 handpiece (WH-10207550)

W&H Ancillary Items



WH-04363600 Disposable Irrigation Tubing, 2.2m (box of 6)

(Implantmed and Elcomed SA-310)



WH-04757100 Irrigation Spray Clip for External and Internal Irrigation (set of 3)



WH-10940011 MD-400 Service-Oil F1



WH-02139800 Bur Testing Gauge

Use to verify latch-end instruments (drills, taps, drivers) meet dimensional specifications prior to use.



WH-16934000 IA-400 Prosthodontic Screwdriver

WH-06338400 Irrigation Spike w/ Roller Clamp

WH-04013900 Pump Tube Complete (Implantmed and Elcomed SA-310)

WH-04014000 Spare Pump Tubes (Implantmed and Elcomed SA-310) (set of 3)

WH-00929300 Spray Tubes (box of 10)

WH-04019000 Tube Clamps (Implantmed) (set of 5)

Contra-Angle Surgical Handpieces



WH-10205601	WS-56 E Surgical Handpiece 1:1 Contra-Angle, Fully Dismantleable
WH-10207510	WS-75 E/KM Surgical Handpiece 20:1 Contra-Angle, Fully Dismantleable
WH-10207530	WS-75 E/KM LED G Surgical Handpiece 20:1 Contra-Angle, Fully Dismantleable
WH-10207550	WI-75 E/KM Surgical Handpiece 20:1 Contra-Angle, Mono Block
WH-10207560	WI-75 E/KM LED G Surgical Handpiece 20:1 Contra-Angle, Mono Block
WH-10209201	WS-92 E/3 Surgical Handpiece 1:2.7 Contra-Angle, Speed-Increasing, Fully Dismantleable
WH-12227901	EB-79 ENDO NiTi Handpiece 2:1 Contra-Angle

Angled Surgical Handpieces



WH-10100900	S-9 Surgical Handpiece 1:1 Angled
WH-10101000	S-10 Surgical Handpiece 1:1 Angled, Slim
WH-10101200	S-12 Surgical Handpiece 1:2 Angled, Speed-Increasing, Slim

Straight Surgical Handpieces



WH-00001100	S-11 Surgical Handpiece 1:1 Straight
WH-00001101	SL-11 Surgical Handpiece 1:1 Straight, Long
WH-00001120	SI-11 LED G Surgical Handpiece 1:1 Straight, Mono Block
WH-00001130	S-11 LED G Surgical Handpiece 1:1 Straight



BioHorizons proudly distributes W&H implant motors, handpieces and accessories. Additional W&H products and re-order items are available. For more information, contact your BioHorizons representative or visit the online catalog (www.biohorizons.com).

LASER-LOK HEALING ABUTMENTS

Laser-Lok Healing Abutments

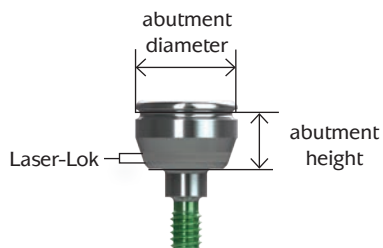

Use Laser-Lok healing abutments when a Laser-Lok abutment restoration is planned to inhibit epithelial downgrowth, establish a soft tissue seal and protect the bone. After removing a Laser-Lok healing abutment to make an impression, use a new Laser-Lok abutment (healing, temporary or final) to establish the soft tissue connection again.

	abutment diameter	3mm height	5mm height
Narrow Emergence			
3.5mm platform, Laser-Lok	3.8mm	PYNHA3L	PYNHA5L
4.5mm platform, Laser-Lok	4.7mm	PGNHA3L	PGNHA5L
5.7mm platform, Laser-Lok	5.9mm	PBNHA3L	PBNHA5L
Regular Emergence			
3.0mm platform, Laser-Lok	3.5mm	TP3HA3L	TP3HA5L
3.5mm platform, Laser-Lok	4.5mm	PYRHA3L	PYRHA5L
4.5mm platform, Laser-Lok	5.5mm	PGRHA3L	PGRHA5L
5.7mm platform, Laser-Lok	6.6mm	PBRHA3L	PBRHA5L
Wide Emergence			
3.0mm platform, Laser-Lok	4.2mm	TP3WHA3L	TP3WHA5L
3.5mm platform, Laser-Lok	5.8mm	PYWHA3L	PYWHA5L
4.5mm platform, Laser-Lok	6.8mm	PGWHA3L	PGWHA5L

Simple Solutions with Laser-Lok Healing Abutments

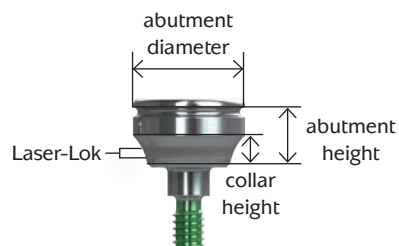

Use Laser-Lok Simple Solutions healing abutments when a Simple Solutions abutment restoration is planned to inhibit epithelial downgrowth, establish a soft tissue seal and protect the bone. A Simple Solutions restoration avoids having to remove and replace the abutment to take an impression because the snap cap closed tray impression transfer connects to the final abutment. See L01017 or L02007 for more information.

	abutment diameter	2mm height (0.8mm collar)	3mm height (1.8mm collar)	3.5mm height (2.8mm collar)
3.5mm platform, Laser-Lok	5.0mm	PYHA08L	PYHA18L	PYHA28L
4.5mm platform, Laser-Lok	6.0mm	PGHA08L	PGHA18L	PGHA28L
5.7mm platform, Laser-Lok	7.0mm	PBHA08L	PBHA18L	PBHA28L

STANDARD HEALING ABUTMENTS & COVER CAPS

Healing Abutments



Hand-tighten with the .050" (1.25mm) Hex Driver. Titanium Alloy.

The 3.5, 4.5 and 5.7mm healing abutments are laser marked for easy intraoral identification of the prosthetic platform, emergence and height:

- Y = Yellow (3.5mm) platform
- G = Green (4.5mm) platform
- B = Blue (5.7mm) platform
- N, R or W = Narrow, Regular or Wide emergence
- 1, 3 or 5 = 1mm, 3mm or 5mm abutment height

3.0 healing abutments are not laser marked due to their small size.

	abutment diameter	1mm height	3mm height	5mm height
Narrow Emergence				
3.5mm platform	3.8mm	PYNHA1	PYNHA3	PYNHA5
4.5mm platform	4.7mm	PGNHA1	PGNHA3	PGNHA5
5.7mm platform	5.9mm	PBNHA1	PBNHA3	PBNHA5
Regular Emergence				
3.0mm platform	3.5mm	-	TP3HA3	TP3HA5
3.5mm platform	4.5mm	-	PYRHA3	PYRHA5
4.5mm platform	5.5mm	-	PGRHA3	PGRHA5
5.7mm platform	6.6mm	-	PBRHA3	PBRHA5
Wide Emergence				
3.0mm platform	4.2mm	-	TP3WHA3	TP3WHA5
3.5mm platform	5.8mm	-	PYWHA3	PYWHA5
4.5mm platform	6.8mm	-	PGWHA3	PGWHA5

Cover Caps



- TP3CC** 3.0mm Cover Cap
- PYCC** 3.5mm Cover Cap
- PGCC** 4.5mm Cover Cap
- PBCC** 5.7mm Cover Cap

Use during submerged surgical healing. Hand-tighten with the .050" (1.25mm) Hex Driver. Titanium Alloy. *Included with implant but can also be ordered separately.*

INSTRUCTIONS FOR USE

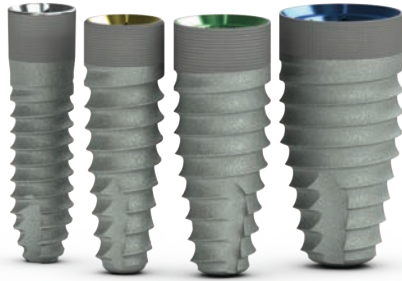

This surgical manual serves as a reference for using the Tapered Internal and Tapered Internal 3.0 implants and surgical instruments. It is intended solely to provide instructions on the use of BioHorizons products. It is not intended to describe the methods or procedures for diagnosis, treatment planning, or placement of implants, nor does it replace clinical training or a clinician's best judgment regarding the needs of each patient. BioHorizons strongly recommends appropriate training as a prerequisite for the placement of implants and associated treatment.

The procedures illustrated and described within this manual reflect idealized patient presentations with adequate bone and soft tissue to accommodate implant placement. No attempt has been made to cover the wide range of actual patient conditions that may adversely affect surgical and prosthetic outcomes. **Clinician judgment as related to any specific case must always supersede any recommendations made in this or any BioHorizons literature.**

Before beginning any implant surgical procedure with BioHorizons implants:



- Read and understand the Instructions for Use that accompany the products.
- Clean and sterilize the surgical tray and instruments per Instructions for Use.
- Become thoroughly familiar with all instruments and their uses.
- Study surgical kit layout and iconography.
- Design a surgical treatment plan to satisfy the prosthetic requirements of the case.



Small diameter implants and angled abutments are intended for the anterior region of the mouth and are not intended for the posterior region of the mouth due to possible failure of the implant.

Indications

Tapered Internal Implants are intended for use in the mandible or maxilla as an artificial root structure for single tooth replacement or for fixed bridgework and dental retention. The implants may be restored immediately:

- 1) with a temporary prosthesis that is not in functional occlusion or
- 2) when splinted together for multiple tooth replacement or when stabilized with an overdenture supported by multiple implants.

Tapered Internal 3.0 Implants may be used as an artificial root structure for single tooth replacement of mandibular central and lateral incisors and maxillary lateral incisors. The implants may be restored immediately:

- (1) with a temporary prosthesis that is not in functional occlusion,
- (2) when splinted together as an artificial root structure for multiple tooth replacement of mandibular incisors, or
- (3) for denture stabilization using multiple implants in the anterior mandible and maxilla.

The implants may be placed in immediate function when good primary stability has been achieved and with appropriate occlusal loading.

SURGICAL PROTOCOLS

Two-Stage Protocol



Implant with cover cap in a two-stage protocol.

In a two-stage surgery, the implant is placed below the soft tissue and protected from occlusal function and other forces during osseointegration. A low-profile cover cap is placed on the implant to protect it from the ingress of soft tissue.

Following osseointegration, a second procedure exposes the implant and a transmucosal healing abutment is placed to allow for soft tissue healing and development of a sulcus. Prosthetic restoration begins after soft tissue healing.

Single-Stage Protocol

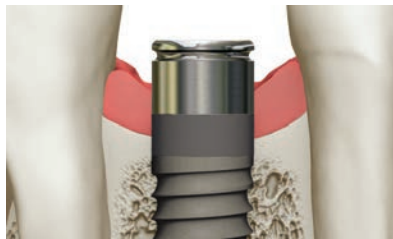

Implant with removable healing abutment in a single-stage protocol.

Single-stage surgery may be accomplished by placing a healing abutment at the time of implant surgery. This eliminates the need for a second procedure. Although the implant is not in occlusal function, some forces can be transmitted to it through the exposed transmucosal element.

Prosthetic restoration begins following osseointegration of the implant and soft tissue healing.

Non-functional Immediate Restoration



Implant restored with a non-functional provisional prosthesis.

Single-stage surgery with non-functional immediate provisionalization provides the patient a non-functioning provisional prosthesis early in the treatment plan. An abutment is placed on the implant at or shortly after surgery, and a provisional restoration is secured using temporary cement. The provisional can help contour the soft tissue profile during healing.

Immediate Function Restoration



Implants with a splinted prosthesis in immediate function.

Single-stage surgery with immediate function is possible in good quality bone where multiple implants exhibiting excellent initial stability can be splinted together. Splinting implants together may offer a biomechanical advantage over individual, unsplinted prostheses.

IMPLANT PLACEMENT LEVEL & SPACING

Placement in Uneven Ridges

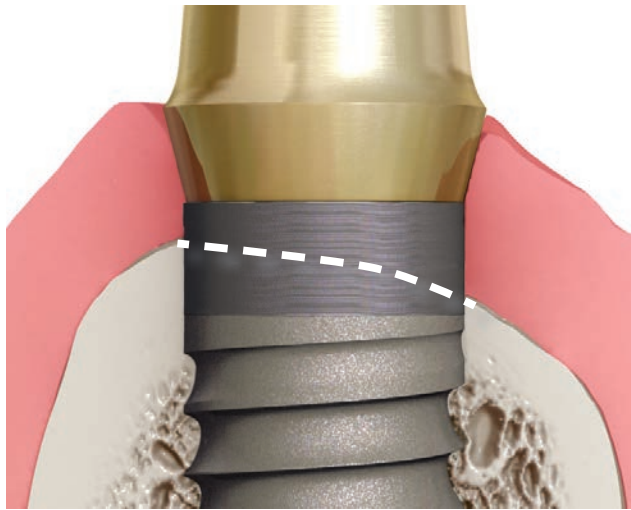

When placing the implant in an uneven ridge, prepare the osteotomy and place the implant so the bone/soft-tissue junction is within the Laser-Lok transition zone. This will allow both soft tissue and bone to attach to the Laser-Lok collar. If the ridge discrepancy is more than the Laser-Lok transition zone, leveling the ridge can be considered.

Implant-to-Tooth Spacing

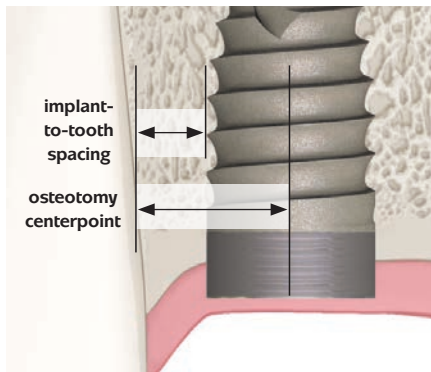

The osteotomy centerpoint required to maintain a specific implant-to-tooth spacing is calculated according to this formula:

$$\frac{1}{2} (\text{implant body diameter}) + \text{the desired spacing.}$$



During implant placement, clinicians must apply their best judgment as to the appropriate spacing for individual patient conditions.

Implant-to-Implant Spacing

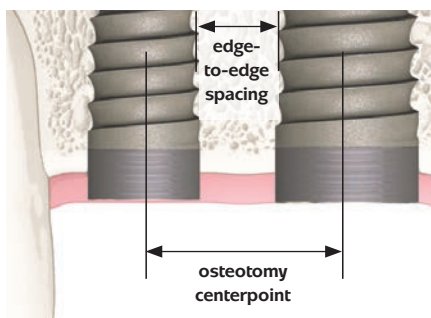

The osteotomy center-to-center measurement required to maintain a specific edge-to-edge spacing between two implants is calculated according to this formula:

$$\frac{1}{2} (\text{sum of 2 implant body diameters}) + \text{the desired spacing.}$$



During implant placement, clinicians must apply their best judgment as to the appropriate spacing for individual patient conditions.

SURGICAL KIT & DRILL SEQUENCE

Surgical Kit Instructions

All BioHorizons surgical kits use an intuitive layout to guide the surgeon through the instrument sequence. The sequence begins in the upper left hand corner and works left-to-right and then down.

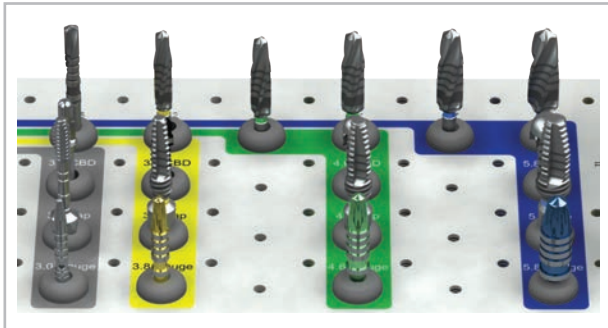

The drilling section is color-coded by implant body diameter (gray=3.0mm, yellow=3.8mm, green=4.6mm and blue=5.8mm).

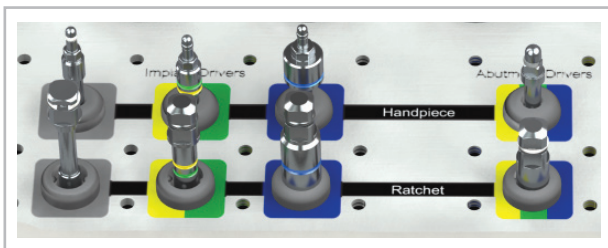

The implant driver section is color-coded by prosthetic platform (gray=3.0mm, yellow=3.5mm, green=4.5mm and blue=5.7mm).

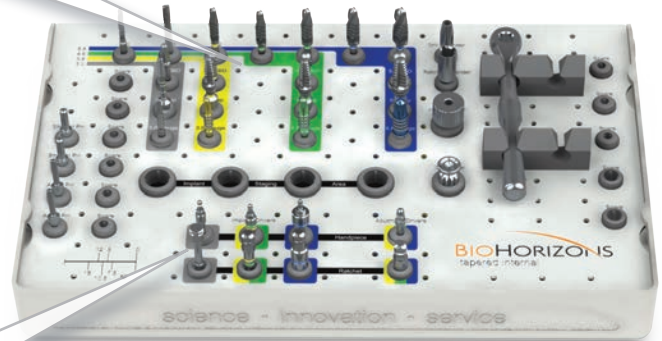

Prior to use, clean and sterilize the surgical tray and instruments according to the Instructions for Use included with the kit. Study the surgical kit layout, color-coding and iconography. Surgical assistants should be thoroughly familiar with all instruments and their uses prior to initiating the surgical procedure.

Drill Sequence

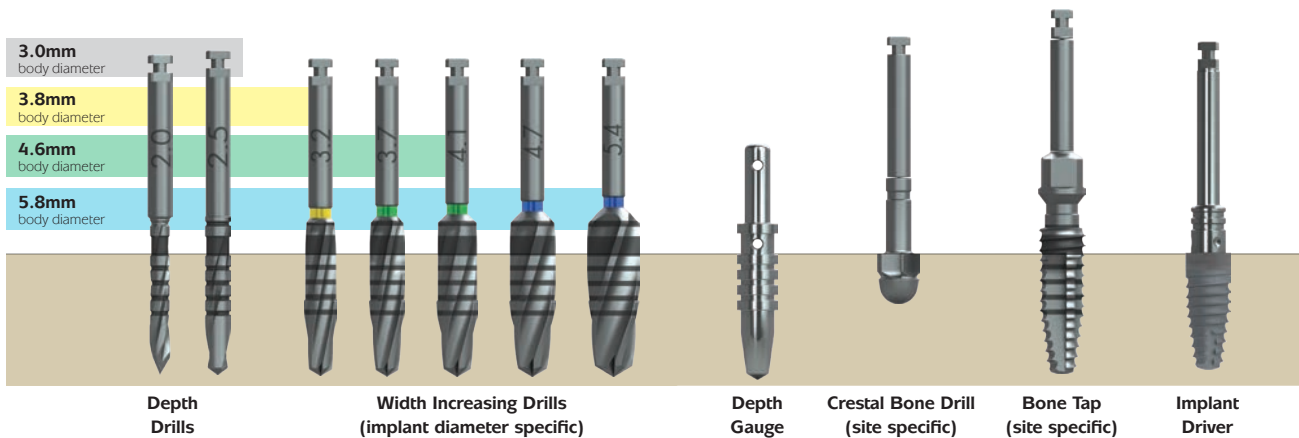

DRILL OVERVIEW

Drill Markings

All surgical drills included with this system are externally irrigated and designed to be used at drill speeds of 850-2500 rpm² with steady sterile irrigation. Reduced drill speed may be indicated in softer bone or as drill diameter increases.

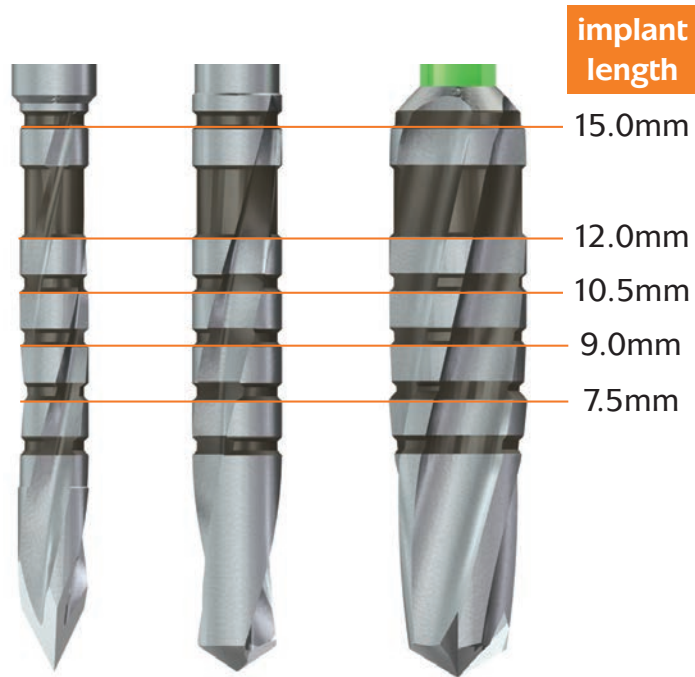

Note: The depth marks are consistent throughout the starter drills, depth drills and width increasing drills

Important Considerations

- Peri-operative oral rinses with a 0.12% Chlorhexidine Digluconate solution have been shown to significantly lower the incidence of post-implantation infectious complications.³ A pre-operative 30-second rinse is recommended, followed by twice daily rinses for two weeks following surgery.
- Drilling must be done under a constant stream of sterile irrigation. A pumping motion should be employed to prevent over-heating the bone. Surgical drills and taps should be replaced when they are worn, dull, corroded or in any way compromised. BioHorizons recommends replacing drills after 12 to 20 osteotomies.⁴ A Drill-usage Tracking Chart is available at biohorizons.com to record this important information.
- There is a risk of injury to the mandibular nerve associated with surgical drilling in posterior mandibular regions. To minimize the risk of nerve injury, it is imperative that the clinician understands the drill depth markings as they relate to the implant length to produce the desired vertical placement of the implant.

OSTEOTOMY INITIALIZATION

2.0mm Starter Drill



2.0mm Starter Drill

Purpose: Initiate osteotomy.

- Chisel-tip design eliminates “skating” on osseous crest
- Prepares site for paralleling pins
- Matte finish for increased visibility under operator lights

2.5mm Depth Drill



2.5mm Depth Drill

Purpose: Set osteotomy depth.

- Efficient cutting drill design collects bone for autografting
- Matte finish for increased visibility under operator lights
- Final drill for 3.0mm implant

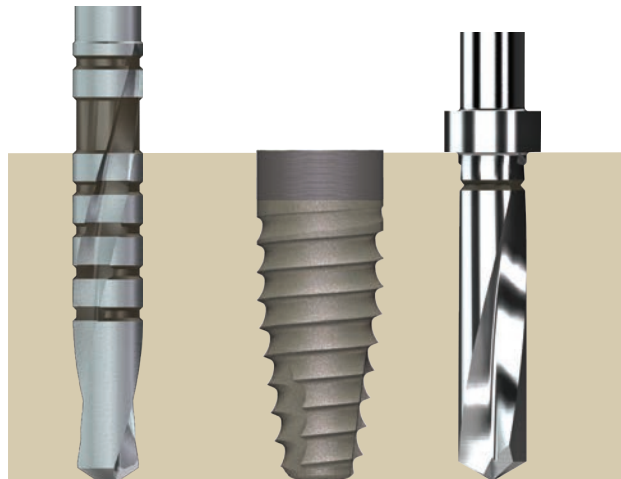

The 2.0mm and 2.5mm depth drills are designed to increase and/or set the depth of the osteotomy.

2.5mm Depth Drills with Stops



Purpose: Set osteotomy depth when access or visibility is poor.

- Fixed circular ring acts as a definitive drill stop
- One drill length for each implant length
- 1 mm laser-etched line guides supracrestal implant placement
- BioHorizons Surgical Kit includes spare slots for depth drills with stops or extended shank drills
- Optional final drill for 3.0mm implant

OSTEOTOMY MODIFICATION

Paralleling Pins



Purpose: Evaluate osteotomy position and angle.

- Provided straight or with a 20° angle
- Use after 2.0mm Starter Drill and 2.5mm Depth Drill
- 9mm shank for radiographic evaluation of proximity to adjacent anatomy
- Hub diameter is 4.0mm

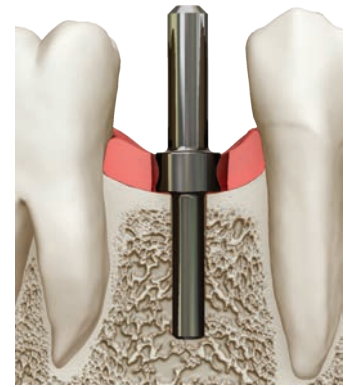

Width Increasing Drills



Purpose: Incrementally widen the osteotomy to reduce heat generation.

- Depth-marked for reference
- Efficient cutting drill design collects bone for autografting
- The drill tip has limited end cutting. However, the osteotomy depth can be increased with these drills as needed
- Matte finish for increased visibility under operatory lights
- Color-coded by implant body diameter (gray=3.0mm, yellow=3.8mm, green=4.6mm and blue=5.8mm)

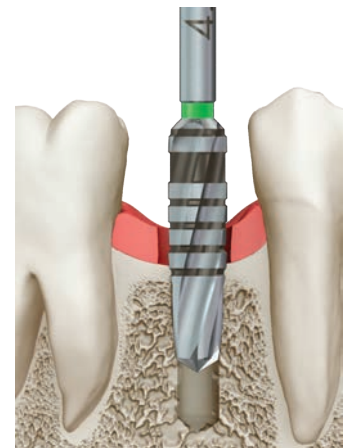

Depth Gauges



Purpose: Verify osteotomy depth.

- Depth marks for reference
- Use following the final width increasing drill for each implant
- Place the depth gauge into the osteotomy site, adjust osteotomy depth as necessary
- Can also be used after 2mm drill by inverting
- Color-coded by implant body diameter (gray=3.0mm, yellow=3.8mm, green=4.6mm and blue=5.8mm)

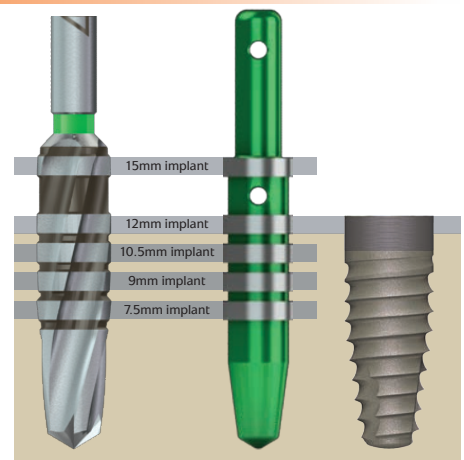

Width increasing drill

Depth gauge

12mm implant with Laser-Lok

FINAL BONE PREPARATION & DRIVERS

Crestal Bone Drills



Purpose: Remove cortical bone at ridge crest for pressure-free seating of the implant collar.

- Use when dense cortical bone is present at crest
- Rounded non-end cutting hub centers drill in osteotomy
- Use following the final width increasing drill for each implant



Fully seat drill.

Implant level with osseous crest.

Bone Taps



Purpose: Prepare dense cortical bone for implant threads.

- Site specific
- 30 rpm or less⁵
- Final instrument prior to implant placement
- Can be driven with a handpiece, ratchet or hand wrench

Place into the osteotomy, apply firm apical pressure and rotate slowly in a clockwise direction. When the threads engage, allow the tap to feed without excessive pressure. To remove, rotate the bone tap in a counter-clockwise direction, allowing it to back out of the osteotomy. **Do not pull on the bone tap to remove it from the site.**

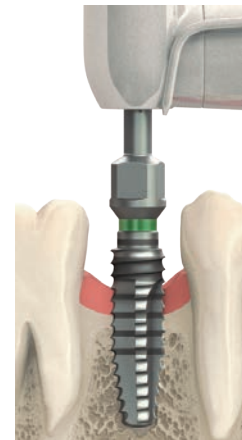

Implant Drivers



Purpose: Engage the implant's internal hex to drive mount-free implants into the osteotomy at 30 rpm or less.⁵

Drivers are color coded by prosthetic connection:

- gray = 3.0mm platform
- yellow/green = 3.5/4.5mm platform
- blue = 5.7mm platform

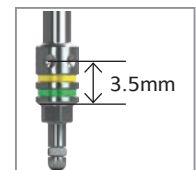

IMPLANT TRANSFER

Implant Pick-up

Vial caps are color coded by body diameter (3.0=white, 3.8mm=yellow, 4.6mm=green, 5.8mm=blue).

Cover caps and implant drivers are color coded by prosthetic platform (3.0mm=gray, 3.5mm=yellow, 4.5mm=green, 5.7mm=blue).

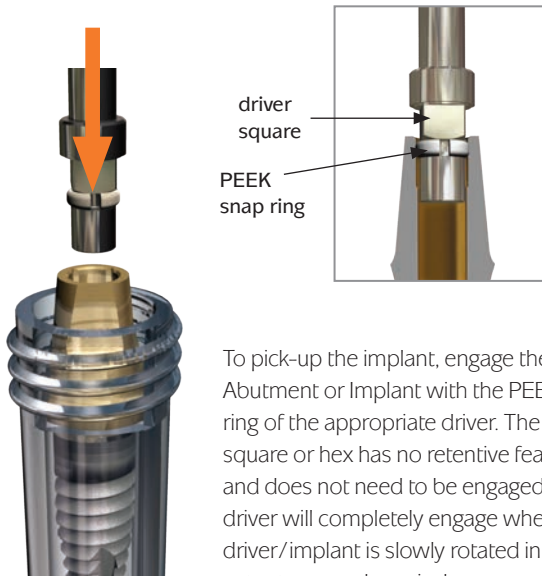

To pick-up the implant, engage the 3inOne Abutment or Implant with the PEEK snap ring of the appropriate driver. The driver square or hex has no retentive feature and does not need to be engaged. The driver will completely engage when the driver/implant is slowly rotated into the osteotomy under apical pressure.

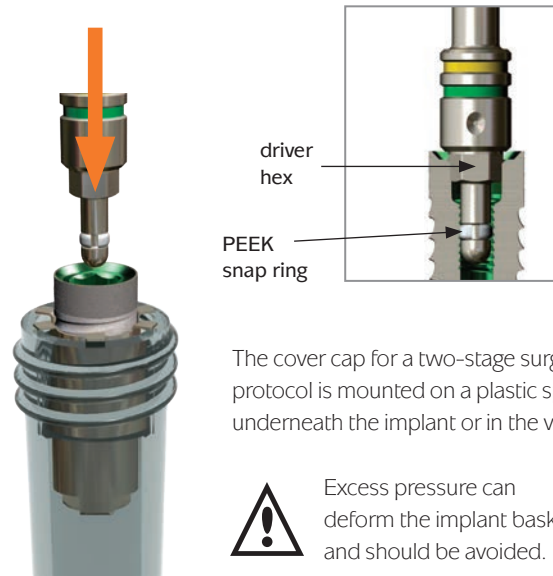

The cover cap for a two-stage surgical protocol is mounted on a plastic spacer underneath the implant or in the vial cap.



Excess pressure can deform the implant basket and should be avoided.

Implant Placement

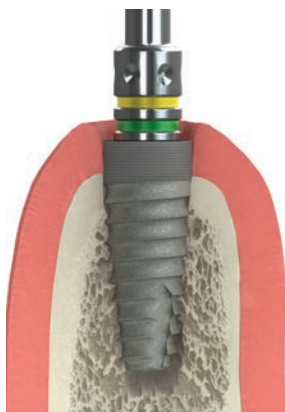

Place the apex of the implant into the osteotomy and begin rotating slowly. The driver hex will engage when the driver is slowly rotated under apical pressure. If too much resistance is felt during insertion, remove the implant and revise the osteotomy with the appropriate crestal bone drill or bone tap as deemed necessary to reduce insertion torque.

Internal Hex Orientation

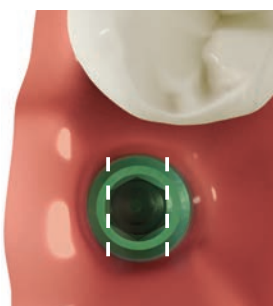

When seating the implant, use the corresponding dimples on the driver to orient one internal hex flat perpendicular to the implant angulation plane. Doing so verifies that an angled abutment will correct the angulation.

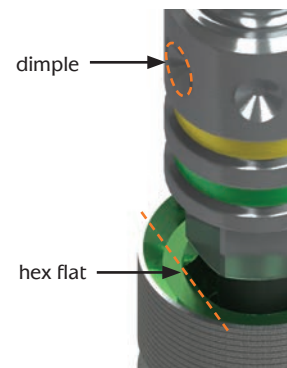

HEALING PROTOCOLS

Cover Caps for two-stage protocol



Purpose: Protects prosthetic platform in two-stage (submerged) surgical protocols.

- Irrigate implant to remove blood and other debris
- Use an antibacterial paste to decrease the risk of bacterial growth
- Thread clockwise into implant body
- Hand-tighten (10-15 Ncm) utilizing .050" (1.25mm) Hex Driver
- Color-coded by prosthetic platform

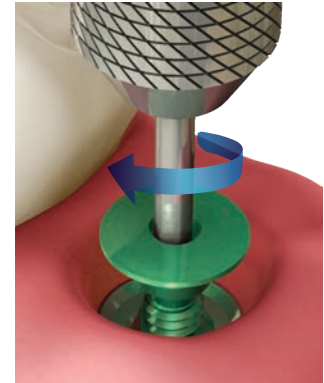

Healing Abutments for single-stage protocol



Purpose: Transmucosal element for developing soft tissue emergence with narrow, regular, wide emergence or Simple Solutions prosthetic components.

- Hand-tighten (10-15 Ncm) utilizing .050" (1.25mm) Hex Driver
- Color-coded by prosthetic platform
- The 3.5, 4.5 and 5.7mm healing abutments are laser marked for easy intraoral identification; for example: GR3 = Green (4.5mm) platform / Regular Emergence / 3mm High
- If a Laser-Lok temporary or final restoration is planned, a Laser-Lok healing abutment is required



Immediate Provisional Restorative Options



Temporary Abutments

Purpose: Titanium and PEEK temporaries are easily modified for fabrication of cement or screw-retained provisional restorations. A long direct coping screw (purchased separately) may be used to maintain the screw access hole during the fabrication of a screw-retained provisional prosthesis.



Simple Solutions with Laser-Lok

Purpose: When a Simple Solutions restoration is planned, the tooth-colored healing cap that comes packaged with the abutment may be used as a coping for an immediate provisional restoration. See L01017 or L02007 for more information.

APPENDIX

Post-operative Instructions

A period of unloaded healing time is often recommended to allow for integration between the bone and implant surface. This is dependent on individual patient healing rates and bone quality of the implant site. Each case must be independently evaluated.

The patient should be instructed to follow a post-surgical regimen including cold packs for 24 hours post-implantation. The patient's diet should consist of soft foods and possibly dietary supplements. Pharmacological therapy should be considered as the patient's condition dictates.

If a removable prosthesis is used during the initial healing phase, a soft liner material should be used to prevent pressure on the surgical site. Relieve the prosthesis over the implant site prior to the soft liner application. Periodically check the patient's soft tissue and bone healing using clinical and radiographic evaluations.

Ongoing hygiene for the implant patient is vital. Hygiene recall appointments at three month intervals are suggested. Instruments designed for implant abutment scaling, such as Im placare® instruments from Hu-Friedy® should be utilized. The stainless steel handles may be fitted with assorted tip designs for hygiene on natural teeth. The Im placare® scalers contain no glass or graphite fillers that can scratch titanium implant abutments.

Bone Profilers



Purpose: In cases where excess crestal bone has been created, use a bone profiler at implant uncover to contour the bone. This will provide the necessary clearance for proper abutment seating.

- 850-2,500 rpm drill speed with steady sterile irrigation²
- Profiler guide protects implant platform
- Color-coded by prosthetic platform (gray=3.0mm, yellow=3.5mm, green=4.5mm, blue=5.7mm)

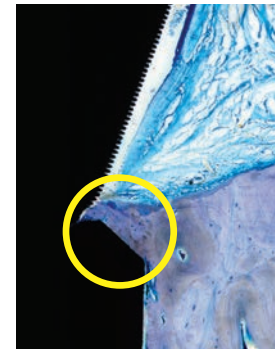
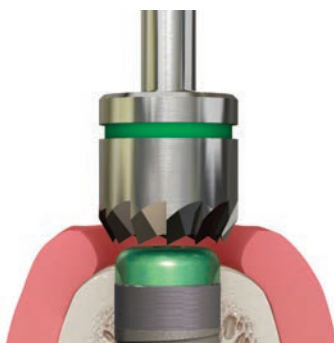

Image showing exceptional bone growth at 3 months. (Myron Nevins, DDS)



Do not use the profiler without the guide in place.

Using an .050" hex driver, remove the surgical cover cap from the implant and place the profiler guide that matches the color of the prosthetic platform. Use the profiler with copious amounts of sterile irrigation. Once the excess bone and soft tissue are removed, unscrew the guide and seat the appropriate prosthetic component.

ICON LEGEND & REFERENCES

Symbol Descriptions for Product Labeling

REF Reference/article number

LOT Lot/batch number

Use before expiration date (YYYY-MM)

Manufacture date (YYYY-MM)

STERILE Sterile by gamma irradiation

NON-STERILE Non-sterile

Rx Only Caution: Federal (USA) law restricts these devices to the sale, distribution and use by, or on the order of, a dentist or physician.

Artwork label number

Prosthetic platform

- 3.0mm Prosthetic Platform
- 3.5mm Prosthetic Platform
- 4.5mm Prosthetic Platform
- 5.7mm Prosthetic Platform

Single use only

Refer to Instructions for Use

BioHorizons products carry the CE mark and fulfill the requirements of the Medical Devices Directive 93/42/EEC

EU Authorised Representative
Quality First International
London E7 0QY United Kingdom
Tel. & Fax: +44-208-522-1937

4.6 x 12
Tapered Internal Implant

BIOHORIZONS®
Birmingham, AL 35244 USA

REF TLR4612

RBT, Laser-Lok
Ø4.6 x 12mm, 4.5 Platform

LOT YYXXXXX

YYYY-MM expires

do not re-use

YYYY-MM manufacture date

see instructions for use

STERILE gamma irradiated

Rx Only
LTLR4612 Rev A

CE 0473

BioHorizons Tapered Internal
REF TLR4612 **LOT** YYXXXXX
Ø4.6 x 12mm, 4.5 Platform

BioHorizons Tapered Internal
REF TLR4612 **LOT** YYXXXXX
Ø4.6 x 12mm, 4.5 Platform

body diameter	prosthetic platform
3.0mm (gray box label, white blister label & vial cap)	3.0mm (gray internal hex & cover cap)
3.8mm (yellow box label, blister label & vial cap)	3.5mm (yellow internal hex & cover cap)
4.6mm (green box label, blister label & vial cap)	4.5mm (green internal hex & cover cap)
5.8mm (blue box label, blister label & vial cap)	5.7mm (blue internal hex & cover cap)

References

- Osseointegration on metallic implant surfaces: effects of microgeometry and growth factor treatment. SR Frankel, J Simon, H Alexander, M Dennis, JL Ricci. *J Biomed Mater Res.* 2002;63(6): 706-13.
- Density of Bone: Effect on Surgical Approach and Healing. CE Misch. *Contemporary Implant Dentistry, Second Edition.* Mosby: St. Louis, 1999. 371-384.
- The influence of 0.12 percent chlorhexidine digluconate rinses on the incidence of infectious complications and implant success. Lambert PM, Morris HF, Ochi S. *J Oral Maxillofac Surg* 1997;55(12 supplement 5):25-30.
- Heat production by 3 implant drill systems after repeated drilling and sterilization. Chacon GE, Bower DL, Larsen PE, McGlumphy EA, Beck FM. *J Oral Maxillofac Surg.* 2006 Feb;64(2):265-9.
- Root Form Surgery in the Edentulous Mandible: Stage I Implant Insertion. CE Misch. *Contemporary Implant Dentistry Second Edition.* Mosby: St. Louis, 1999. 347-369.

ORDERING & WARRANTY INFORMATION

Product Support Specialist: _____

Cell phone: _____

Fax: _____

BioHorizons Lifetime Warranty on Implants and Prosthetics: All BioHorizons implants and prosthetic components include a Lifetime Warranty. BioHorizons implant or prosthetic components will be replaced if removal of that product is due to failure (excluding normal wear to overdenture attachments).

Additional Warranties: BioHorizons warranties instruments, surgical drills, taps, torque wrenches and Virtual Implant Placement (VIP) treatment planning software.

(1) Surgical Drills and Taps: Surgical drills and taps include a warranty period of ninety (90) days from the date of initial invoice. Surgical instruments should be replaced when they become worn, dull, corroded or in any way compromised. Surgical drills should be replaced after 12 to 20 osteotomies.⁴

(2) Instruments: The BioHorizons manufactured instrument warranty extends for a period of one (1) year from the date of initial invoice. Instruments include drivers, sinus lift components, implant site dilators and BioHorizons tools used in the placement or restoration of BioHorizons implants.

(3) VIP treatment planning software: VIP treatment planning software warranty extends for a period of ninety (90) days from the date of initial invoice. The warranty requires that VIP be used according to the minimum system requirements.

(4) Compu-Guide surgical templates: Compu-Guide surgical templates are distributed without making any modifications to the submitted Compu-Guide Prescription Form and VIP treatment plan ("as is"). BioHorizons does not make any warranties expressed or implied as it relates to surgical templates.

Return Policy: Product returns require a Return Authorization Form, which can be acquired by contacting Customer Care. The completed Return Authorization Form should be included with the returned product. For more information, please see the reverse side of the invoice that was shipped with the product.

Disclaimer of Liability: BioHorizons products may only be used in conjunction with the associated original components and instruments according to the Instructions for Use (IFU). Use of any non-BioHorizons products in conjunction with BioHorizons products will void any warranty or any other obligation, expressed or implied.

Treatment planning and clinical application of BioHorizons products are the responsibility of each individual clinician. BioHorizons strongly recommends completion of postgraduate dental implant education and adherence to the IFU that accompany each product. BioHorizons is not responsible for incidental or consequential damages or liability relating to use of our products alone or in combination with other products other than replacement or repair under our warranties.

Compu-Guide surgical templates are ordered under the control of a Clinician. The Clinician recognizes responsibility for use. Therefore, regardless of the real or proven damages, the liability to BioHorizons is limited to the price of the product directly related to the reason for the claim.

Distributed Products: For information on the manufacturer's warranty of distributed products, please refer to their product packaging. Distributed products are subject to price change without notice.

Validity: Upon its release, this literature supersedes all previously published versions.

Availability: Not all products shown or described in this literature are available in all countries. BioHorizons continually strives to improve its products and therefore reserves the right to improve, modify, change specifications or discontinue products at any time.

Any images depicted in this literature are not to scale, nor are all products depicted.

Direct Offices

BioHorizons USA
888-246-8338 or
205-967-7880

BioHorizons Canada
866-468-8338

BioHorizons Spain
+34 91 713 10 84

BioHorizons UK
+44 (0)1344 752560

BioHorizons Germany
+49 761-556328-0

BioHorizons Australia
+61 2 8399 1520

BioHorizons Chile
+56 2 361 9519

Distributors

For contact information in our 85 markets, visit www.biohorizons.com

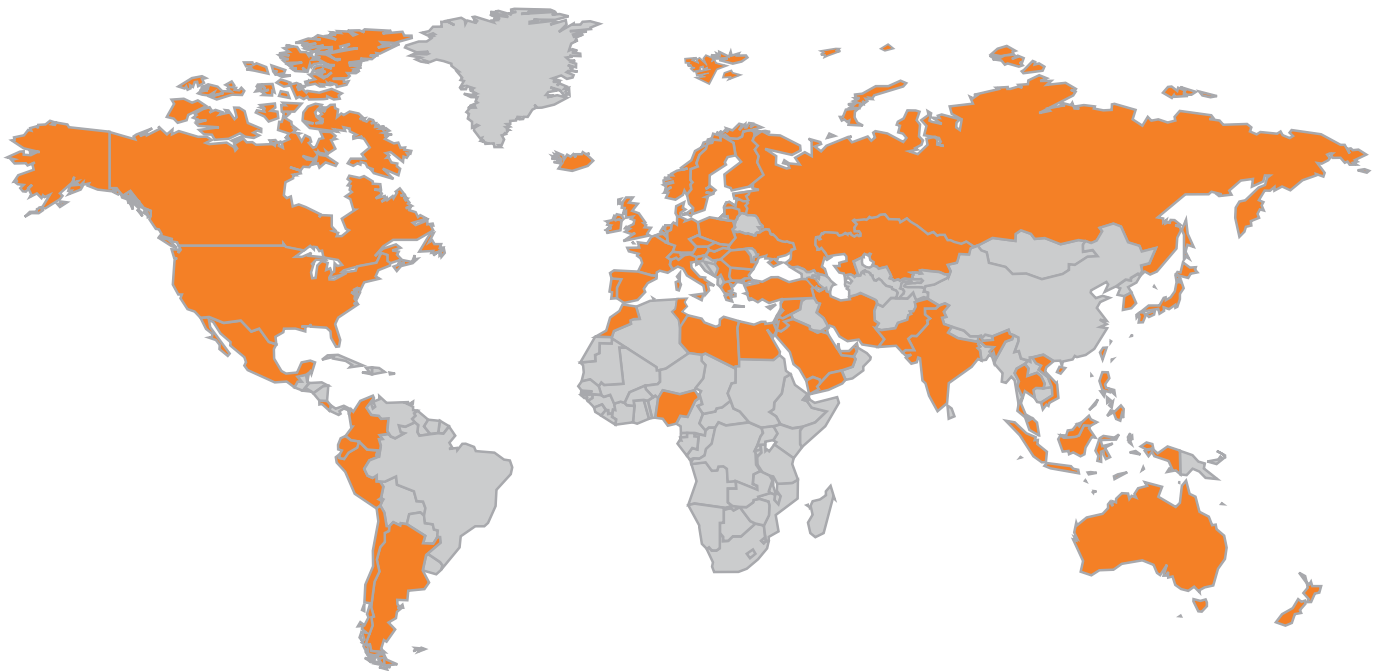

BioHorizons®, Laser-Lok®, MinerOss®, AutoTac® and Mem-Lok® are registered trademarks of BioHorizons. Unigrip™ is a trademark of Nobel Biocare AB. Zimmer® Dental ScrewVent® and Tapered ScrewVent® are registered trademarks of Zimmer, Inc. AlloDerm® and AlloDerm GBR® are registered trademarks of LifeCell Corporation. The ARTISAN™ Space Maintenance System and Grafton® DBM are registered trademarks of Medtronic, Inc. INFUSE® Bone Graft, the PROGENIX® Family of Grafts, and the MASTERGRAFT® Family of Products are registered trademarks of Medtronic Sofamor Danek Inc. Spiralock® is a registered trademark of Spiralock Corporation. Pomalux® is a registered trademark of Westlake Plastics Co. Locator is a registered trademark of Zest Anchors, Inc. Delrin® is a registered trademark of E.I. du Pont de Nemours and Company. LADDEC® is a registered trade mark of OST-Développement. LADDEC® is manufactured by OST-Développement. MinerOss® Cancellous is processed by DCI Donor Services Tissue Bank. Mem-Lok® is manufactured by Collagen Matrix, Inc. Not all products shown or described in this literature are available in all countries. As applicable, BioHorizons products are cleared for sale in the European Union under the EU Medical Device Directive 93/42/EEC and the tissues and cells Directive 2004/23/EC. We are proud to be registered to ISO 13485:2003, the international quality management system standard for medical devices, which supports and maintains our product licences with Health Canada and in other markets around the globe. Original language is English. ©BioHorizons. All Rights Reserved.



L01029



REV A MAR 2013

shop online at
www.biohorizons.com